

# AI Network Video Recorder

## User's Manual

**V 1.0.2**

# Foreword

## General





This user's manual (hereinafter referred to be "the Manual") introduces the installation, functions and operations of the AI Network Video Recorder (AI NVR) devices (hereinafter referred to be "the Device").

## Models

Series	Model
8-HDD	Advanced 64-channel 2U 8HDD AI NVR; Advanced 32-channel 2U 8HDD AI NVR; General 32-channel 2U 8HDD AI NVR
4-HDD	Advanced 32-channel 1.5U 4HDD 16PoE AI NVR; General 16-channel 1.5U 4HDD 16PoE AI NVR; General 32-channel 1.5U 4HDD AI NVR
2-HDD	Advanced 16-channel 1U 2HDD 16PoE AI NVR; General 16-channel 1U 2HDD 16PoE AI NVR; Advanced 16-channel 1U 2HDD 8PoE AI NVR; General 8-channel 1U 2HDD 8PoE AI NVR; General 16-channel 1U 2HDD AI NVR

## Safety Instructions

The following categorized signal words with defined meaning might appear in the Manual.

Signal Words	Meaning
 CAUTION	Indicates a potential risk which, if not avoided, may result in property damage, data loss, lower performance, or unpredictable result.
 ESD	Electrostatic Sensitive Devices. Indicates a device that is sensitive to electrostatic discharge.
 TIPS	Provides methods to help you solve a problem or save you time.
 NOTE	Provides additional information as the emphasis and supplement to the text.

## Revision History

Version	Revision Content	Release Time
V1.0.2	Update the description of rear panel.	May 2019
V1.0.1	<ol style="list-style-type: none"> <li>1. Add 16 Channel 1U 2HDD 16PoE AI NVR and 16 Channel 1U 2HDD 8PoE AI NVR. Update relevant info.</li> <li>2. Update icons on the rear panel.</li> <li>3. Add video structurization function and non-motor vehicle detection function.</li> </ol>	September 2018
V1.0.0	First release.	—

## Privacy Protection Notice

As the device user or data controller, you might collect personal data of others such as face, fingerprints, car plate number, Email address, phone number, GPS and so on. You need to be in compliance with the local privacy protection laws and regulations to protect the legitimate rights and interests of other people by implementing measures including but not limited to: providing clear and visible identification to inform data subject the existence of surveillance area and providing related contact.

## About the Manual

- The Manual is for reference only. If there is inconsistency between the manual and the actual product, the actual product shall prevail.
- We are not liable for any loss caused by the operations that do not comply with the manual.
- The manual would be updated according to the latest laws and regulations of related regions. For detailed information, see the paper manual, CD-ROM, QR code or our official website. If there is inconsistency between paper manual and the electronic version, the electronic version shall prevail.
- All the designs and software are subject to change without prior written notice. The product updates might cause some differences between the actual product and the manual. Please contact the customer service for the latest program and supplementary documentation.
- There still might be deviation in technical data, functions and operations description, or errors in print. If there is any doubt or dispute, please refer to our final explanation.
- Upgrade the reader software or try other mainstream reader software if the manual (in PDF format) cannot be opened.
- All trademarks, registered trademarks and the company names in the manual are the properties of their respective owners.
- Please visit our website, contact the supplier or customer service if there is any problem occurred when using the device.
- If there is any uncertainty or controversy, please refer to our final explanation.

# Important Safeguards and Warnings

The following description is the correct application method of the device. Read the manual carefully before use to prevent danger and property loss. Strictly conform to the manual during application and keep it properly after reading.

## Operating Requirement

- Install the PoE front-end device indoors.
- The device does not support wall mount.
- Do not place and install the device in an area exposed to direct sunlight or near heat generating device.
- Do not install the device in a humid, dusty or fuliginous area.
- Keep its horizontal installation, or install it at stable places, and prevent it from falling.
- Do not drip or splash liquids onto the device; do not put on the device anything filled with liquids, in order to prevent liquids from flowing into the device.
- Install the device at well-ventilated places; do not block its ventilation opening.
- Use the device only within rated input and output range.
- Do not dismantle the device arbitrarily.
- Transport, use and store the device within allowed humidity and temperature range.

## Power Requirement

- Make sure to use the designated battery type. Otherwise there may be explosion risk.
- Make sure to use batteries according to requirements. Otherwise, it may result in fire, explosion or burning risks of batteries!
- To replace batteries, only the same type of batteries can be used.
- Make sure to dispose the exhausted batteries according to the instructions.
- The product shall use electric wires (power wires) recommended by this area, which shall be used within its rated specification.
- Make sure to use standard power adapter matched with this device. Otherwise, the user shall undertake resulting personnel injuries or device damages.
- Use power supply that meets SELV (safety extra low voltage) requirements, and supply power with rated voltage that conforms to Limited Power Source in IEC60950-1. For specific power supply requirements, please refer to device labels.
- Products with category I structure shall be connected to grid power output socket, which is equipped with protective grounding.
- Appliance coupler is a disconnecting device. During normal use, please keep an angle that facilitates operation.



# Table of Contents

Foreword.....	I
Important Safeguards and Warnings.....	III
<b>1 Features .....</b>	<b>1</b>
1.1 Overview.....	1
1.2 Features.....	1
<b>2 Front Panel and Rear Panel .....</b>	<b>4</b>
2.1 Front Panel .....	4
2.2 Rear Panel.....	5
2.2.1 Advanced 2U 8HDD AI NVR/General 2U 8HDD AI NVR Series .....	5
2.2.2 Advanced 1.5U 4HDD 16PoE AI NVR/General 1.5U 4HDD 16PoE AI NVR/General 1.5U 4HDD AI NVR Series.....	6
2.2.3 Advanced 1U 2HDD 16PoE AI NVR /Advanced 1U 2HDD 8PoE AI NVR/General 1U 2HDD 16PoE AI NVR Series.....	8
2.2.4 General 1U 2HDD 8PoE AI NVR Series.....	11
2.2.5 General 1U 2HDD AI NVR Series.....	12
2.3 Alarm Connection .....	14
2.3.1 Alarm Port.....	14
2.3.2 Alarm Input Port.....	15
2.3.3 Alarm Output Port.....	15
2.3.4 Alarm Relay Specifications.....	16
2.4 Bidirectional talk.....	16
2.4.1 Device-end to PC-end.....	16
2.4.2 PC-end to the device-end .....	17
2.5 Mouse Operation .....	17
2.6 Remote Control.....	18
<b>3 Device Installation.....</b>	<b>1</b>
3.1 Device Installation Diagrams .....	1
3.2 Check Unpacked NVR.....	2
3.3 About Front Panel and Rear Panel.....	2
3.4 HDD Installation.....	2
3.4.1 1U Series.....	2
3.4.2 1.5U/2U Series .....	4
3.5 CD-ROM Installation.....	7
3.6 Connection Sample .....	9
3.6.1 Advanced 2U 8HDD AI NVR/General 2U 8HDD AI NVR Series .....	9
3.6.2 Advanced 1.5U 4HDD 16PoE AI NVR/General 1.5U 4HDD 16PoE AI NVR/General 1.5U 4HDD AI NVR Series.....	10
3.6.3 Advanced 1U 2HDD 16PoE AI NVR/General 1U 2HDD 16PoE AI NVR/Advanced 1U 2HDD 8PoE AI NVR/General 1U 2HDD 8PoE AI NVR/General 1U 2HDD AI NVR Series.....	10
<b>4 Local Basic Operation .....</b>	<b>1</b>

4.1 Getting Started.....	1
4.1.1 Boot up and Shut down.....	1
4.1.2 Device Initialization.....	2
4.1.3 Reset Password.....	5
4.1.4 Quick Settings.....	9
4.2 Camera.....	27
4.2.1 Connection.....	27
4.2.2 Remote Device Initialization.....	30
4.2.3 Short-Cut Menu to Register Camera.....	35
4.2.4 Image.....	36
4.2.5 Encode.....	37
4.2.6 Channel Name.....	41
4.2.7 Remote Upgrade.....	42
4.2.8 Remote Device Info.....	43
4.3 Preview.....	45
4.3.1 Preview.....	45
4.3.2 Navigation bar.....	46
4.3.3 Preview Control Interface.....	49
4.3.4 Right-Click Menu.....	51
4.3.5 AI Preview Mode.....	53
4.3.6 Sequence.....	55
4.3.7 Preview Display Effect Settings.....	58
4.4 PTZ.....	63
4.4.1 PTZ Settings.....	63
4.4.2 PTZ Control.....	65
4.5 Record File.....	70
4.6 Playback and Search.....	70
4.6.1 Instant Playback.....	70
4.6.2 Search Interface.....	70
4.6.3 Smart Search Playback.....	78
4.6.4 Mark Playback.....	79
4.6.5 Playback Image.....	80
4.6.6 Splice Playback.....	81
4.6.7 Smart Search.....	81
4.6.8 File List.....	100
4.6.9 Other Aux Functions.....	102
4.7 Event Manager.....	102
4.7.1 Video Detect.....	102
4.7.2 Smart Plan.....	109
4.7.3 IVS.....	111
4.7.4 Face Detect.....	134
4.7.5 Face Recognition.....	137
4.7.6 Video Structurization.....	151
4.7.7 People Counting.....	153
4.7.8 Heat Map.....	154
4.7.9 ANPR.....	155

4.7.10 Audio Detect .....	157
4.7.11 Alarm Settings.....	158
4.7.12 Abnormality.....	163
4.7.13 Alarm output .....	165
4.7.14 POS .....	166
4.8 Network.....	170
4.8.1 Network Settings .....	170
4.8.2 Network Test.....	182
4.9 Storage.....	184
4.9.1 Basic.....	184
4.9.2 Schedule.....	185
4.9.3 HDD .....	185
4.9.4 FTP .....	186
4.9.5 Record Control .....	188
4.9.6 HDD Information.....	188
4.9.7 HDD Group.....	190
4.9.8 HDD Detect .....	190
4.9.9 RAID Manager.....	193
4.10 Device Maintenance and Manager.....	195
4.10.1 Account.....	195
4.10.2 System Info.....	205
4.10.3 Voice.....	209
4.10.4 RS232.....	212
4.10.5 Broadcast .....	213
4.10.6 Security.....	215
4.10.7 Auto Maintain.....	218
4.10.8 Backup.....	219
4.10.9 Default .....	223
4.10.10 Upgrade.....	224
4.11 Logout /Shutdown/Restart .....	226
<b>5 Web Operation.....</b>	<b>227</b>
5.1 General Introduction .....	227
5.2 Device Initialization .....	227
5.3 Log In .....	230
5.4 Reset Password.....	231
5.5 LAN Mode .....	232
5.6 Real-time Monitor .....	234
5.7 PTZ .....	235
5.8 Image/Alarm-out .....	237
5.8.1 Image.....	237
5.8.2 Alarm output .....	237
5.9 Zero-channel Encode .....	237
5.10 WAN Login.....	238
5.11 Setup.....	240
5.11.1 Image.....	240
5.11.2 Network.....	250

5.11.3 Event.....	267
5.11.4 Storage .....	318
5.11.5 Setting.....	328
5.12 Information.....	351
5.12.1 Version.....	351
5.12.2 Log.....	352
5.12.3 Online User.....	353
5.12.4 People Counting.....	353
5.12.5 Heat Map .....	354
5.12.6 HDD.....	355
5.13 Playback .....	355
5.13.1 Search Record .....	356
5.13.2 File List .....	356
5.13.3 Playback .....	357
5.13.4 Download.....	357
5.13.5 Load more .....	358
5.14 Smart Search.....	361
5.14.1 IVS.....	361
5.14.2 Face Detection .....	362
5.14.3 Face Recognition .....	364
5.14.4 Vehicle Detection.....	367
5.14.5 Human Body Detection .....	369
5.14.6 Non-Motor Vehicle Detection .....	370
5.15 Alarm.....	371
5.16 Log out.....	372
5.17 Un-install Web Control.....	373
<b>6 Glossary.....</b>	<b>374</b>
<b>7 FAQ .....</b>	<b>375</b>
<b>Appendix 1 HDD Capacity Calculation .....</b>	<b>380</b>
<b>Appendix 2 Compatible Network Camera List.....</b>	<b>381</b>
<b>Appendix 3 Cybersecurity Recommendations .....</b>	<b>386</b>

# 1 Features

## 1.1 Overview

This series NVR is a high performance network video recorder. This series product support local preview, multiple-window display, recorded file local storage, remote control and mouse shortcut menu operation, and remote management and control function.

This series product supports center storage, front-end storage and client-end storage. The monitor zone in the front-end can be set in anywhere. Working with other front-end devices such as IPC, NVS, this series product can establish a strong surveillance network via the CMS. In the network system, there is only one network cable from the monitor center to the monitor zone in the whole network. There is no audio/video cable from the monitor center to the monitor zone. The whole project is featuring of simple connection, low-cost, low maintenance work.

This series NVR can be widely used in many areas such as public security, water conservancy, transportation and education.

## 1.2 Features

### AI Functions

- Different models have different AI functions. The actual product shall govern.
- Face detection. It includes front-end smart detection and rear-end smart detection.
- Face recognition. It enables users to compare the detected faces with the images in the face library at real time.
- Human body detection. System activates alarm actions once human body is detected.
- People counting. It can effectively count the population number and flow direction.
- Heat map. It can monitor the active objects in a specific area.
- Automatic number plate recognition (ANPR). It can effectively monitor the passing vehicles.

### Smart Playback

- IVS playback. It can screen out and replay the records meeting the set rules.
- Face detection playback. It can screen out and replay the records with human faces.
- Face recognition playback. It can compare the face information in the video with the information in the database and replay the corresponding records.
- ANPR playback. It can screen out the record with a specific car plate number or all the records with car plate numbers.
- Human body detection playback. It can screen out and replay the records with specific human bodies.
- Smart Search. It includes smart functions such as searching by attribute and searching by image to enable users to get target records quickly.

## Cloud Upgrade

For the NVR connected to the Internet, it supports application online upgrade.

## Real-Time Surveillance

- VGA, HDMI port. Connect to monitor to realize real-time surveillance. Some series support TV/VGA/HDMI output at the same time.
- Short-cut menu for preview.
- Support multiple popular PTZ decoder control protocols. Support preset, tour and pattern.

## Playback

- Support independent real-time recording for each channel. At the same time it supports functions such as smart search, forward play, network monitor, record search and download.
- Support various playback modes: slow play, fast play, backward play and frame-by-frame play.
- Support time title overlay so that you can view the event accurate occurred time.
- Support specified zone enlargement.

## User Management

Each group has an authority collection which can be edited freely and belongs to the total authority collection. The authorities of any user in the group cannot be larger than that of the group.

## Storage

- Via corresponding settings (such as alarm settings and schedule settings), you can back up related audio/video data in the network video recorder.
- You can take records via the Web and the record files are saved on the PC in which the client locates.

## Alarm

- Respond to external alarm simultaneously (within 200MS). Based on user's pre-defined relay settings, the system can process the alarm input correctly and sends user screen or voice prompts (supporting pre-recorded audio).
- Support settings of the central alarm server, so that the system can automatically notify users of the alarm information. Alarm input can be derived from various connected peripheral devices.
- Alert you of alarm information via email.

## Network Surveillance

- Send audio/video data compressed by IPC or NVS to client-ends through the network, and then the data will be decompressed and displayed.
- Support max 128 connections at the same time.
- Transmit audio/video data by protocols such as HTTP, TCP, UDP, MULTICAST and RTP/RTCP.
- Transmit some alarm data or alarm info by SNMP.
- Support WEB access in WAN/LAN.

## Window Split

Adopt video compression and digital processing to display several windows in one monitor. Support 1/4/8/9/16/ 25/36 window split in preview and 1/4/9/16 window split in playback.

## Record

Support regular record, motion record, alarm record and smart record. Save the recorded files in the HDD, USB device, client-end PC or network storage server and you can search or playback the saved files at the local-end or via the Web/USB devices.

## Backup

Support network backup and USB record backup. You can back up the record files in devices such as network storage server, peripheral USB2.0 device and burner.

## Network Management

- Supervise NVR configuration and control power via Ethernet.
- Support Web management.

## Peripheral Equipment Management

- Support peripheral device control and you can freely set the control protocol and connection port.
- Support transparent data transmission such as RS232 (RS-422) and RS485 (RS-485).

## Auxiliary

- Support switch between NTSC and PAL.
- Support real-time display of system resources information and running status.
- Support log record.
- Local local GUI output. Shortcut menu operation with the mouse.
- IR control function (for some series only). Shortcut menu operation with remote control.
- Support to play the video/audio files from remote IPC or NVS.

 NOTE

For description of other function, see the following contents.

# 2 Front Panel and Rear Panel

 NOTE

The following front panel and rear panel figures are for reference only. The actual product shall prevail.

## 2.1 Front Panel

Figure 2-1 takes Advanced 64-channel 2U 8HDD AI NVR and Advanced 32-channel 2U 8HDD AI NVR series as examples, and the actual products shall prevail.

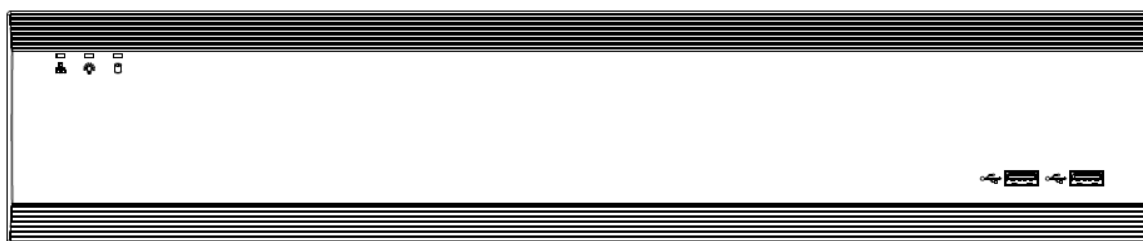





Figure 2-1

Figure 2-2 takes Advanced 32-channel 1.5U 4HDD 16PoE AI NVR/Advanced 16-Channel 1U 2HDD 16PoE AI NVR/Advanced 16-channel 1U 2HDD 8PoE AI NVR as examples, and the actual products shall prevail.



Figure 2-2

Icon	Name	Function
	Network status indicator	<ul style="list-style-type: none"><li>The indicator is off when the network is normal.</li><li>The indicator glows blue when the network is abnormal.</li></ul>
	Power status indicator	<ul style="list-style-type: none"><li>The indicator glows blue when the power supply is normal.</li></ul>
	System status indicator	<ul style="list-style-type: none"><li>The indicator glows when the device is running properly. The indicator is off when the device is in malfunction.</li></ul>
	USB port	Connect to external devices such as USB storage device and mouse.



## 2.2 Rear Panel

### 2.2.1 Advanced 2U 8HDD AI NVR/General 2U 8HDD AI NVR Series



#### NOTE

- Figure 2-3 takes Advanced 2U 8HDD AI NVR/General 2U 8HDD AI NVR series as examples.
- The figure is for reference only. The actual product shall prevail.

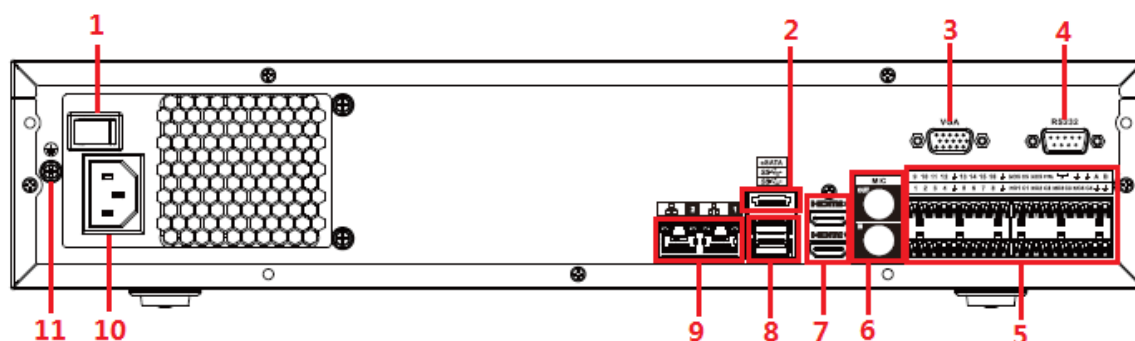



Figure 2-3

No.	Port Name	Function
1	Power button	Turns on/off the NVR.
2	eSATA port	External SATA port. It can connect device with SATA port. You need to jump the HDD when there is peripherally connected HDD.
3	VGA port	VGA video output port. Output analog video signal. It can connect to the monitor to view analog video.
4	RS232 port	It is for general COM debugging to configure IP address and transfer transparent COM data.
5	Alarm input port (1-16)	<ul style="list-style-type: none"> <li>● There are four groups: 1-4, 5-8, 9-12 and 13-16. They receive signals from external alarm source. Alarm input includes two types; NO (normal open) and NC (normal close).</li> <li>● When your alarm input device is using external power, make sure the device and the NVR have the same GND.</li> </ul>
	Alarm output port (NO1-NO5, C1-C5, NC5)	<ul style="list-style-type: none"> <li>● Five groups of alarm output ports (Group 1: NO1-C1, Group 2: NO2-C2, Group 3: NO3-C3, Group 4: NO4-C4, Group 5: NO5, C5, NC5). Output alarm signal to the external alarm device. Make sure power supply is available for the external alarm device.</li> <li>● NO: Normal open alarm output port.</li> <li>● C: Alarm output public end.</li> <li>● NC: Normal close alarm output port.</li> </ul>
		GND. Alarm input ground port.

No.	Port Name	Function
	RS485 port (A, B)	<ul style="list-style-type: none"> <li>● RS485_A port. Control cable A of the 485 device. It connects external devices such as speed dome and PTZ.</li> <li>● RS485_B port. Control cable B of the 485 device. It connects external devices such as speed dome and PTZ.</li> </ul>
	CTRL	Controllable 12V power output. It is to control the on-off alarm relay output. It can be used to control the device alarm output. At the same time, it can also be used as the power input source of some devices such as alarm detector.
		+12V power output port. It can provide power to some peripheral devices such as camera and alarm device. Make sure the power supply of peripheral device shall be below 1A.
6	MIC IN	Bidirectional talk input port. It is to receive analog audio signal from devices such as microphone, sound pickup.
	MIC OUT	<p>Audio output port. It is to output analog audio signal to devices such as sound box.</p> <ul style="list-style-type: none"> <li>● Bidirectional talk output.</li> <li>● Audio output on 1-window video monitor.</li> <li>● Audio output on 1-window video playback.</li> </ul>
7	HDMI port	High definition audio and video signal output port. It transmits uncompressed high definition video and multiple-channel audio data to displays with HDMI port. The two HDMI ports support 2-channel high definition HDMI output of different sources.
8	USB port	USB3.0 port. Connect to devices such as mouse, USB storage device and USB burner.
9	Network port	10M/100M/1000Mbps self-adaptive Ethernet port. Connect to the network cable.
10	Power input port	Input power of 100V-240V and 50Hz-60Hz.
11		GND.

## 2.2.2 Advanced 1.5U 4HDD 16PoE AI NVR/General 1.5U 4HDD 16PoE AI NVR/General 1.5U 4HDD AI NVR Series

### NOTE

- Figure 2-4 takes Advanced 32-channel 1.5U 4HDD 16PoE AI NVR series as examples.
- The figure is for reference only. The actual product shall prevail.

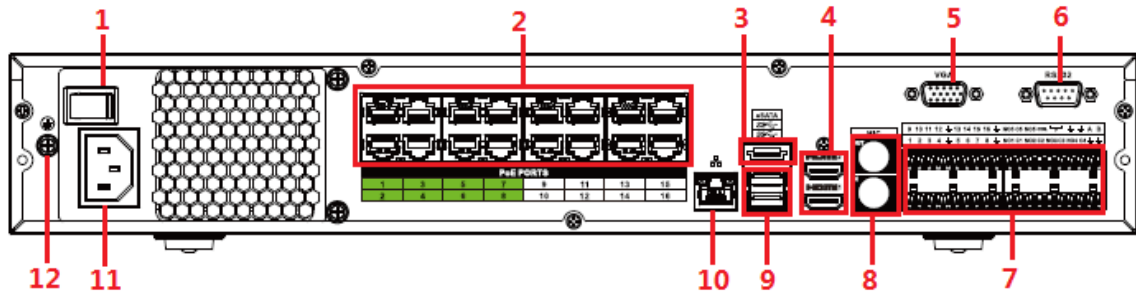



Figure 2-4

No.	Port Name	Function
1	Power button	Turns on/off the NVR.
2	PoE port	<p>Built-in switch. It can provide power for IPC.</p> <ul style="list-style-type: none"> <li>● 16 PoE ports: 1-8 are ePoE ports (support 300m @ 100M. 800m @ 10M). 9-16 are regular PoE ports.</li> <li>● Device with 16 PoEs supports 150W total power.</li> </ul>
3	eSATA port	External SATA port. It can connect device with SATA port. You need to jump the HDD when there is peripherally connected HDD.
4	HDMI port	High definition audio and video signal output port. It transmits uncompressed high definition video and multiple-channel audio data to displays with HDMI port. The two HDMI ports support 2-channel high definition HDMI output of different sources.
5	VGA port	VGA video output port. Output analog video signal. It can connect to the monitor to view analog video.
6	RS232 port	It is for general COM debugging to configure IP address and transfer transparent COM data.
7	Alarm input port (1-16)	<ul style="list-style-type: none"> <li>● There are four groups: 1-4, 5-8, 9-12 and 13-16. They receive signals from external alarm source. Alarm input includes two types; NO (normal open) and NC (normal close).</li> <li>● When your alarm input device is using external power, make sure the device and the NVR have the same GND.</li> </ul>
	Alarm output port (NO1-NO5, C1-C5, NC5)	<ul style="list-style-type: none"> <li>● Five groups of alarm output ports (Group 1: NO1-C1, Group 2: NO2-C2, Group 3: NO3-C3, Group 4: NO4-C4, Group 5: NO5, C5, NC5).Output alarm signal to the external alarm device. Make sure power supply is available for the external alarm device.</li> <li>● NO: Normal open alarm output port.</li> <li>● C: Alarm output public end.</li> <li>● NC: Normal close alarm output port.</li> </ul>
	⏏	GND. Alarm input ground port.
	RS485 port (A, B)	<ul style="list-style-type: none"> <li>● RS485_A port. Control cable A of the 485 device. It connects external devices such as speed dome and PTZ.</li> </ul>

No.	Port Name	Function
		<ul style="list-style-type: none"> <li>● RS485_B port. Control cable B of the 485 device. It connects external devices such as speed dome and PTZ.</li> </ul>
	CTRL	Controllable 12V power output. It is to control the on-off alarm relay output. It can be used to control the device alarm output. At the same time, it can also be used as the power input source of some devices such as alarm detector.
		+12V power output port. It can provide power to some peripheral devices such as camera and alarm device. Make sure the power supply of peripheral device shall be below 1A.
8	MIC IN	Bidirectional talk input port. It is to receive analog audio signal from devices such as microphone, sound pickup.
	MIC OUT	Audio output port. It is to output analog audio signal to devices such as sound box. <ul style="list-style-type: none"> <li>● Bidirectional talk output.</li> <li>● Audio output on 1-window video monitor.</li> <li>● Audio output on 1-window video playback.</li> </ul>
9	USB port	USB3.0 port. Connect to devices such as mouse, USB storage device and USB burner.
10	Network port	10M/100M/1000Mbps self-adaptive Ethernet port. Connect to the network cable.
11	Power input port	Input power of 100V-240V and 50Hz-60Hz.
12		GND.

## 2.2.3 Advanced 1U 2HDD 16PoE AI NVR /Advanced 1U 2HDD 8PoE AI NVR/General 1U 2HDD 16PoE AI NVR Series



These figures are for reference only. The actual product shall prevail.

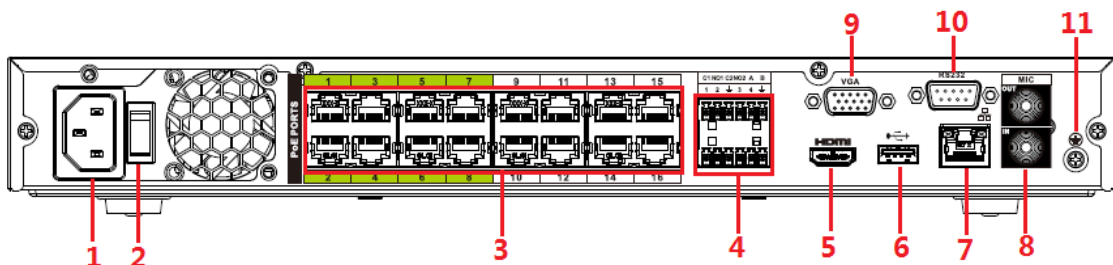

Figure 2-5 NVR5216-16P-I

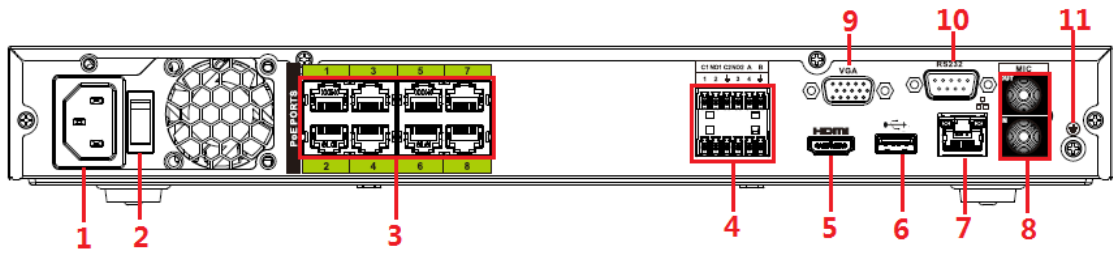

Figure 2-6 NVR5216-8P-I

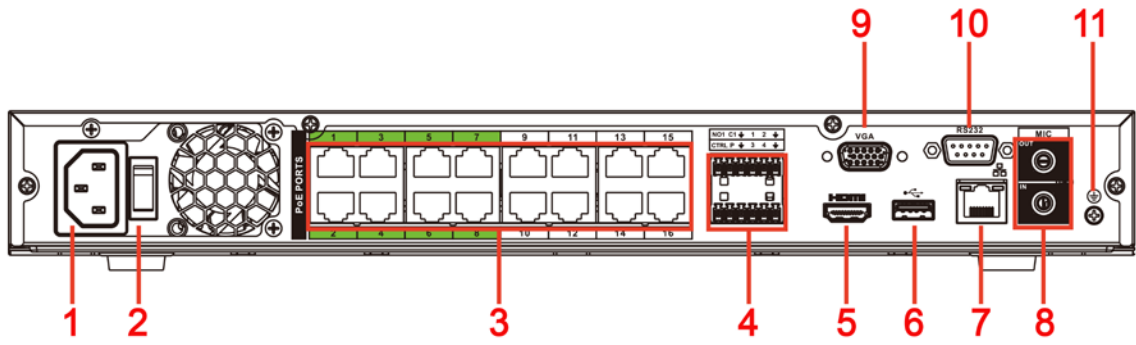





Figure 2-7 NVR4216-16P-I

No.	Port Name	Function	
1	Power input port	Input power of 100V-240V and 50Hz-60Hz.	
2	Power button	Turns on/off the NVR.	
3	PoE port	<p>Built-in switch. It can provide power for IPC.</p> <p>16 PoE ports: 1-8 are ePoE ports (support 300m @ 100M. 800m @ 10M). 9-16 are regular PoE ports. The device supports 150W total power.</p> <p>8 PoE ports: 1-8 are ePoE ports (support 300m @ 100M. 800m @ 10M). The device supports 48V, 120W total power.</p>	
4	Alarm input/output of NVR52-16P-I and 52-8P-I	Alarm input port (1-4)	<ul style="list-style-type: none"> <li>They receive signals from external alarm source. Alarm input includes two types; NO (normal open) and NC (normal close).</li> <li>When your alarm input device is using external power, make sure the device and the NVR have the same GND.</li> </ul>
		Alarm output port (NO1-NO 2, C1-C2)	<ul style="list-style-type: none"> <li>Two groups of alarm output ports (Group 1: NO1-C1, Group 2: NO2-C2). Output alarm signal to the external alarm device. Make sure power supply is available for the external alarm device.</li> <li>NO: Normal open alarm output port.</li> <li>C: Alarm output public end.</li> </ul>
			GND. Alarm input ground port.
		RS485 port (A, B)	<ul style="list-style-type: none"> <li>RS485_A port. Control cable A of the 485 device. It connects external devices such as speed dome and PTZ.</li> <li>RS485_B port. Control cable B of the 485 device. It connects external devices such as speed dome and PTZ.</li> </ul>
	Alarm input/output of NVR4216-16 P-I	Alarm input port (1-4)	<ul style="list-style-type: none"> <li>They receive signals from external alarm source. Alarm input includes two types; NO (normal open) and NC (normal close).</li> <li>When your alarm input device is using external power, make sure the device and the NVR have the same GND.</li> </ul>
		Alarm output port (NO1, C1)	<ul style="list-style-type: none"> <li>One group of alarm output ports (Group 1: NO1-C1). Output alarm signal to the external alarm device. Make sure power supply is available for the external alarm device.</li> <li>NO: Normal open alarm output port.</li> <li>C: Alarm output public end.</li> </ul>
			GND. Alarm input ground port.

No.	Port Name	Function
		CTRL Controllable 12V power output. It is to control the on-off alarm relay output. It can be used to control the device alarm output. At the same time, it can also be used as the power input source of some devices such as alarm detector.
		P +12V power output port. It can provide power to some peripheral devices such as camera and alarm device. Make sure the power supply of peripheral device shall be below 1A.
5	HDMI port	High definition audio and video signal output port. It transmits uncompressed high definition video and multiple-channel audio data to displays with HDMI port.
6	USB port	USB3.0 port. Connect to devices such as mouse, USB storage device and USB burner.
7	Network port	10M/100M/1000Mbps self-adaptive Ethernet port. Connect to the network cable.
8	MIC IN	Bidirectional talk input port. It is to receive analog audio signal from devices such as microphone, sound pickup.
	MIC OUT	Audio output port. It is to output analog audio signal to devices such as sound box. <ul style="list-style-type: none"> <li>● Bidirectional talk output.</li> <li>● Audio output on 1-window video monitor.</li> <li>● Audio output on 1-window video playback.</li> </ul>
9	VGA port	VGA video output port. Output analog video signal. It can connect to the monitor to view analog video.
10	RS232 port	It is for general COM debugging to configure IP address and transfer transparent COM data.
11		GND.

## 2.2.4 General 1U 2HDD 8PoE AI NVR Series



### NOTE

The figure is for reference only. The actual product shall prevail.

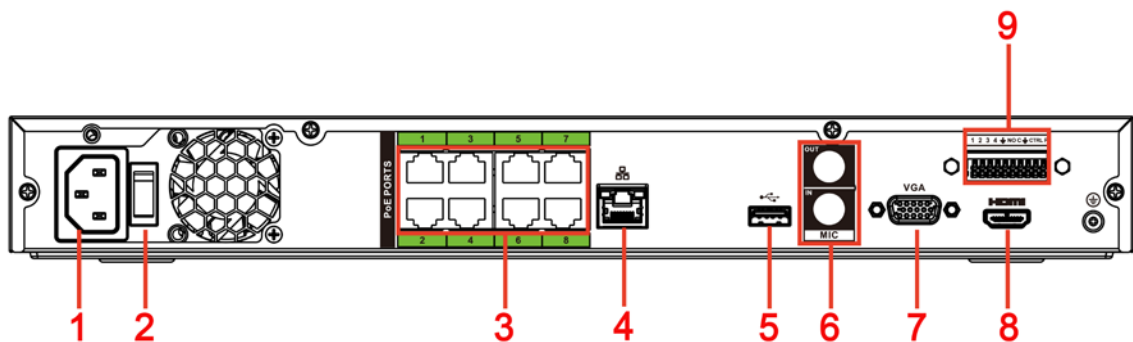



Figure 2-8

No.	Port Name	Function
1	Power input port	Input power of 100V-240V and 50Hz-60Hz.
2	Power button	Turns on/off the NVR.
3	PoE port	Built-in switch. It can provide power for IPC. 8 PoE ports: 1-8 are ePoE ports (support 300m @ 100M. 800m @ 10M). The device supports 48V, 100W total power output under 55°C, and 48V, 130W total power output under 45°C.
4	Network port	10M/100M/1000Mbps self-adaptive Ethernet port. Connect to the network cable.
5	USB port	USB3.0 port. Connect to devices such as mouse, USB storage device and USB burner.
6	MIC IN	Bidirectional talk input port. It is to receive analog audio signal from devices such as microphone, sound pickup.
	MIC OUT	Audio output port. It is to output analog audio signal to devices such as sound box. <ul style="list-style-type: none"> <li>● Bidirectional talk output.</li> <li>● Audio output on 1-window video monitor.</li> <li>● Audio output on 1-window video playback.</li> </ul>
7	VGA port	VGA video output port. Output analog video signal. It can connect to the monitor to view analog video.
8	HDMI port	High definition audio and video signal output port. It transmits uncompressed high definition video and multiple-channel audio data to displays with HDMI port.
9	Alarm input port (1-4)	<ul style="list-style-type: none"> <li>● They receive signals from external alarm source. Alarm input includes two types; NO (normal open) and NC (normal close).</li> <li>● When your alarm input device is using external power, make sure the device and the NVR have the same GND.</li> </ul>
		GND. Alarm input ground port.
	NO C	One NO activation output group. (On-off button).
	CTRL	Controllable power supply output. Control the output of the on-off button alarm relay. It controls the alarm device with the presence or absence of voltage. It can also be used as power input for some alarm devices such as alarm detectors.
	P	Power output port. It can provide power to some peripheral devices such as camera and alarm device. Make sure the power supply of peripheral device shall be below 1A.

## 2.2.5 General 1U 2HDD AI NVR Series



### NOTE

The figure is for reference only. The actual product shall prevail.



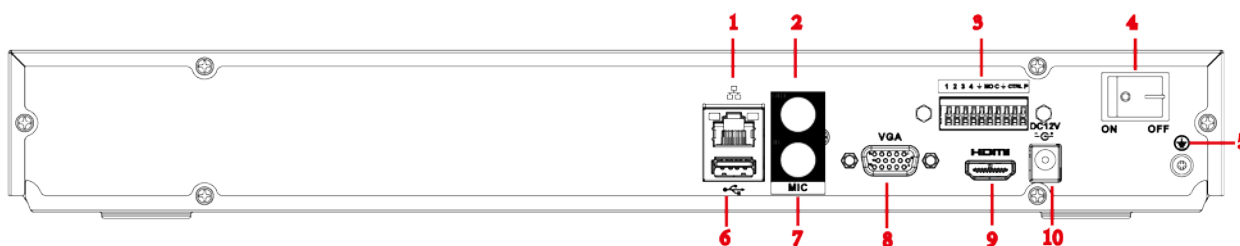

Figure 2-9

No.	Port Name	Function
1	Network port	10M/100M/1000Mbps self-adaptive Ethernet port. Connect to the network cable.
2	MIC OUT	Audio output port. It is to output analog audio signal to devices such as sound box. <ul style="list-style-type: none"> <li>● Bidirectional talk output.</li> <li>● Audio output on 1-window video monitor.</li> <li>● Audio output on 1-window video playback.</li> </ul>
3	Alarm input port (1-4)	<ul style="list-style-type: none"> <li>● They receive signals from external alarm source. Alarm input includes two types; NO (normal open) and NC (normal close).</li> <li>● When your alarm input device is using external power, make sure the device and the NVR have the same GND.</li> </ul>
	$\perp$	GND. Alarm input ground port.
	NO C	One NO activation output group. (On-off button).
	CTRL	Controllable power supply output. Control the output of the on-off button alarm relay. It controls the alarm device with the presence or absence of voltage. It can also be used as power input for some alarm devices such as alarm detectors.
	P	Power output port. It can provide power to some peripheral devices such as camera and alarm device. Make sure the power supply of peripheral device shall be below 1A.
4	Power button	Turns on/off the NVR.
5	$\perp$	GND.
6	USB port	USB3.0 port. Connect to devices such as mouse, USB storage device and USB burner.
7	MIC IN	Bidirectional talk input port. It is to receive analog audio signal from devices such as microphone, sound pickup.
8	VGA port	VGA video output port. Output analog video signal. It can connect to the monitor to view analog video.
9	HDMI port	High definition audio and video signal output port. It transmits uncompressed high definition video and multiple-channel audio data to displays with HDMI port.

No.	Port Name	Function
10	Power input port	Input power of 100V-240V and 50Hz-60Hz.

## 2.3 Alarm Connection

### 2.3.1 Alarm Port

The alarm port is shown as below. See Figure 2-10. The following figure for reference only.

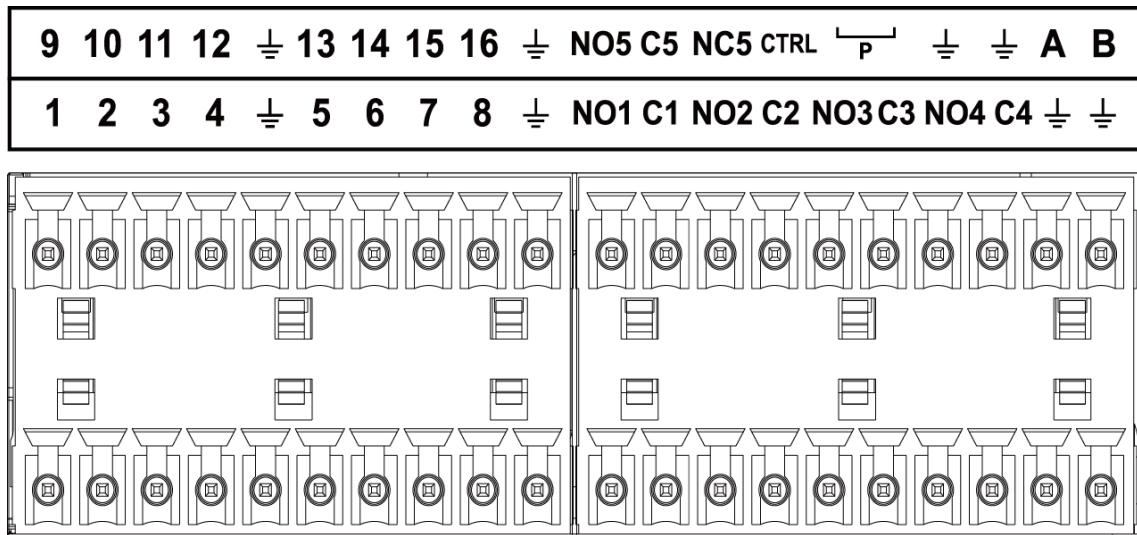



Figure 2-10

Icon	Function
1–16	ALARM1–ALARM16. The alarm becomes activated in the low level.
NO1 C1, NO2 C2, NO3 C3, NO4 C4	Four NO activation output groups. (On-off button).
NO5 C5 NC5	One NO/NC activation output group. (On-off button).
CTRL	Controllable power supply output. Control the output of the on-off button alarm relay. It controls the alarm device with the presence or absence of voltage. It can also be used as power input for some alarm devices such as alarm detectors.
	Power output port. It can provide power to some peripheral devices such as camera and alarm device. Make sure the power supply of peripheral device shall be below 1A.
	GND
A/B	485 communication port. They are used to control devices such as PTZ. Please parallel connect 120TΩ between A/B cables if there are too many PTZ decoders.



#### NOTE

- Different models support different alarm input ports. Please refer to the specifications sheet for detailed information.

- Slight difference may be found on the alarm port layout.

### 2.3.2 Alarm Input Port

Connect the positive end (+) of the alarm input device to the alarm input port (ALARM IN 1–16) of the NVR. Connect the negative end (-) of the alarm input device to the ground end (  ) of the NVR.

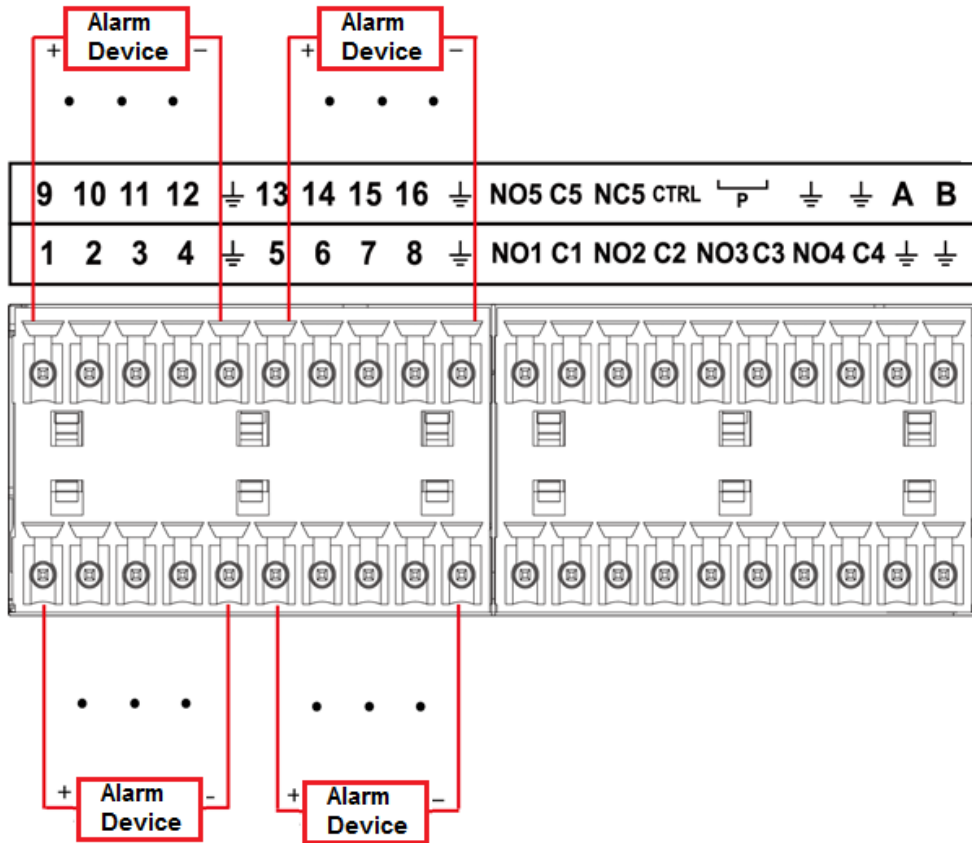



Figure 2-11

 NOTE

- There are two alarm input types: NO/NC.
- When connect the ground port of the alarm device to the NVR, you can use any of the GND ports (  ).
- Connect the NC port of the alarm device to the alarm input port (ALARM) of the NVR.
- When there is peripheral power supplying for the alarm device, please make sure it is earthed with the NVR.

### 2.3.3 Alarm Output Port

- There is peripheral power supplying for the external alarm device.
- In case overload may result in NVR damage, please refer to the following relay specifications for detailed information.
- A/B cable of the RS485 is for the A/B cable connection of the speed PTZ.

## 2.3.4 Alarm Relay Specifications

<b>Model:</b>	<b>JRC-27F</b>	
Material of the touch	Silver	
Rating (Resistance Load)	Rated switch capacity	30VDC 2A, 125VAC 1A
	Maximum switch power	125VA 160W
	Maximum switch voltage	250VAC, 220VDC
	Maximum switch current	1A
Insulation	Between touches with same polarity	1000VAC 1minute
	Between touches with different polarity	1000VAC 1minute
	Between touch and winding	1000VAC 1minute
Surge voltage	Between touches with same polarity	1500V (10×160us)
Length of open time	3ms max	
Length of close time	3ms max	
Longevity	Mechanical	50×10 <sup>6</sup> MIN (3Hz)
	Electrical	200×10 <sup>3</sup> MIN (0.5Hz)
Temperature	-40°C ~+70°C	

## 2.4 Bidirectional talk

### 2.4.1 Device-end to PC-end

#### Device Connection

Please connect the speaker or the pickup to the first audio input port in the device rear panel. Then connect the earphone or the sound box to the audio output port in the PC.

Login the Web and then enable the corresponding channel real-time monitor.

Please refer to the following interface to enable bidirectional talk. See Figure 2-12.

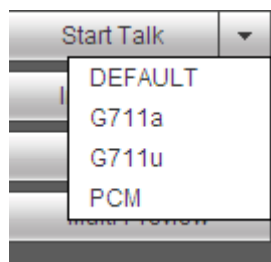

Figure 2-12

#### Listening Operation

At the device end, speak via the speaker or the pickup, and then you can get the audio from the earphone or sound box at the pc-end. See Figure 2-13.

 NOTE

The following figure is for reference only.

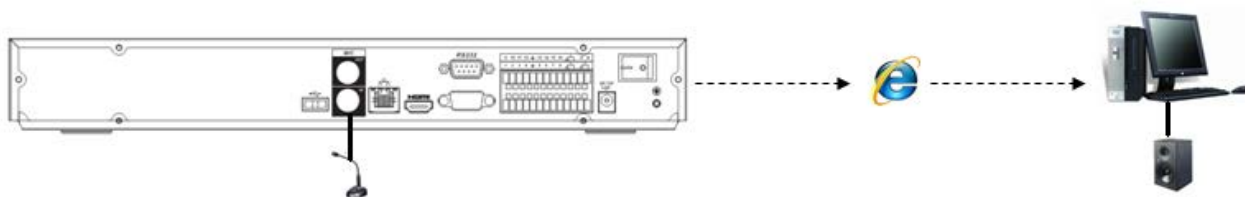

Figure 2-13

## 2.4.2 PC-end to the device-end

### Device Connection

Connect the speaker or the pickup to the audio output port in the PC and then connect the earphone or the sound box to the first audio input port in the device rear panel.

Login the Web and then enable the corresponding channel real-time monitor.

Please refer to the above interface (Figure 2-12) to enable bidirectional talk.

### Listening Operation

At the PC-end, speak via the speaker or the pickup, and then you can get the audio from the earphone or sound box at the device-end. See Figure 2-14.

 NOTE

The following figure is for reference only.

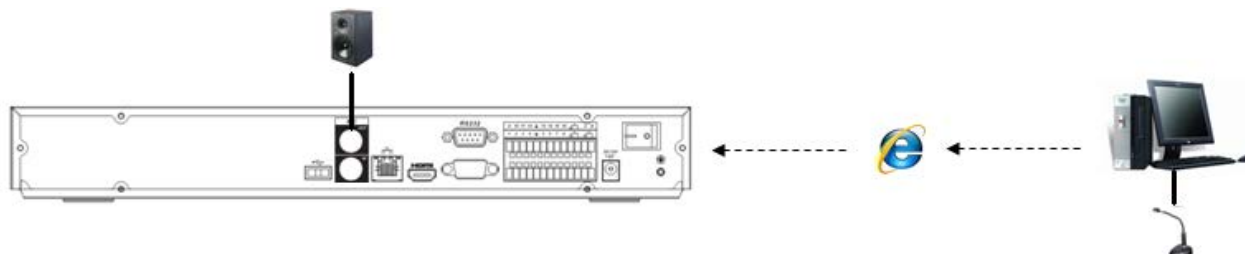
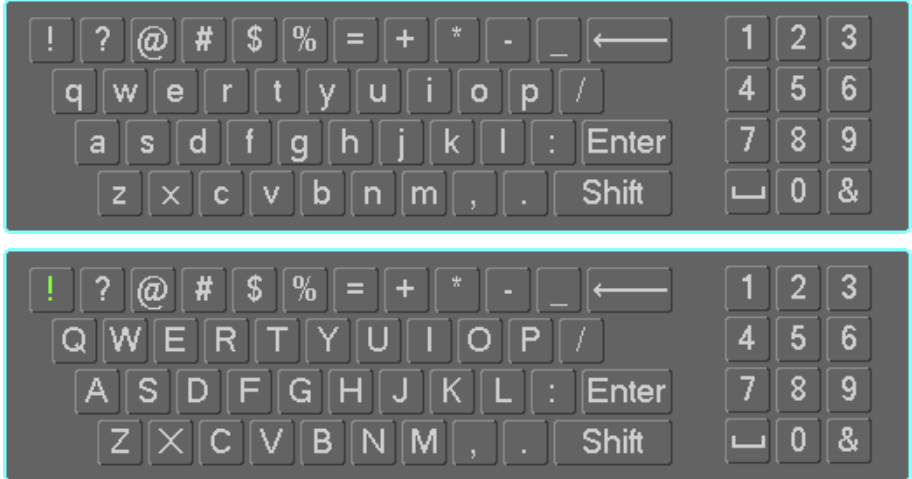

Figure 2-14

## 2.5 Mouse Operation

Please refer to the following sheet for mouse operation instruction.

Left mouse	click	When you have selected one menu item, left click mouse to view menu content.
		Modify checkbox or motion detection status.
		Click combo box to pop up dropdown list

	<p>In input box, you can select input methods. Left click the corresponding button on the panel you can input numeral/English character (small/capitalized). Here ← stands for backspace button. _ stands for space button.</p> <p>In English input mode: _stands for input a backspace icon and ← stands for deleting the previous character.</p>  <p>In numeral input mode: _ stands for clear and ← stands for deleting the previous numeral.</p>
Double left click mouse	<p>Implement special control operation such as double click one item in the file list to playback the video.</p> <p>In multiple-window mode, double left click one channel to view in full-window. Double left click current video again to go back to previous multiple-window mode.</p>
Right click mouse	<p>In real-time monitor mode, pops up shortcut menu.</p> <p>Exit current menu without saving the modification.</p>
Press middle button	<p>In numeral input box: Increase or decrease numeral value.</p> <p>Switch the items in the check box.</p> <p>Page up or page down</p>
Move mouse	Select current control or move control
Drag mouse	<p>Select motion detection zone</p> <p>Select privacy mask zone.</p>

## 2.6 Remote Control

The remote control interface is shown as in Figure 2-15.

Please note remote control is not our standard accessory and it is not included in the accessory bag.

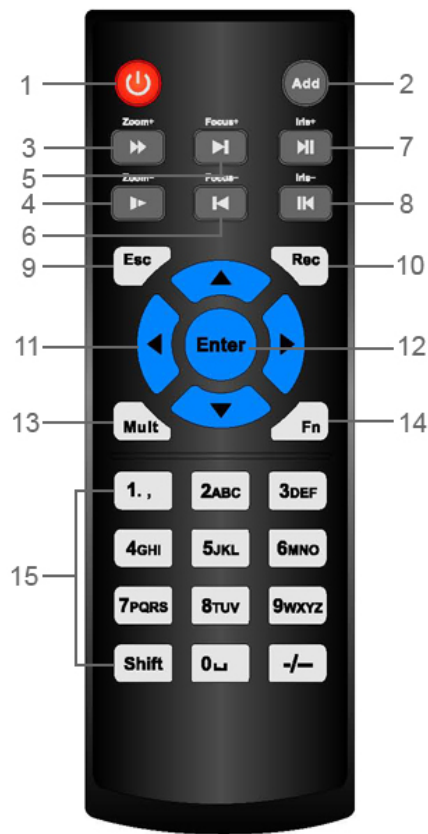

Figure 2-15

Serial Number	Name	Function
1	Power button	Click it to boot up or shut down the device.
2	Address	Click it to input device number, so that you can control it.
3	Forward	Various forward speeds and normal speed playback.
4	Slow play	Multiple slow play speeds or normal playback.
5	Next record	In playback mode, playback the next video.
6	Previous record	In playback mode, playback the previous video.
7	Play/Pause	In pause mode, click this button to realize normal playback.
		In normal playback click this button to pause playback.
		In real-time monitor mode, click this button to enter video search menu.
8	Reverse/pause	Reverse playback pause mode, click this button to realize normal playback.

		In reverse playback click this button to pause playback.
9	Esc.	Go back to previous menu or cancel current operation (close upper interface or control)
10	Record	Start or stop record manually In record interface, working with the direction buttons to select the record channel. Click this button for at least 1.5 seconds, system can go to the Manual Record interface.
11	Direction keys	Switch current activated control, go to left or right. In playback mode, it is to control the playback process bar. Aux function(such as switch the PTZ menu)
12	Enter /menu key	go to default button go to the menu
13	Multiple-window switch	Switch between multiple-window and one-window.
14	Fn	In 1-ch monitor mode: pop up assistant function:PTZ control and Video color.
		Switch the PTZ control menu in PTZ control interface.
		In motion detection interface, working with direction keys to complete setup.
		In text mode, click it to delete character.
15	0-9 number key	Input password, channel or switch channel.
		Shift is the button to switch the input method.



# 3 Device Installation

**Note:** All the installation and operations here should conform to your local electric safety rules.

## 3.1 Device Installation Diagrams

Please refer to the following diagrams to install the NVR.

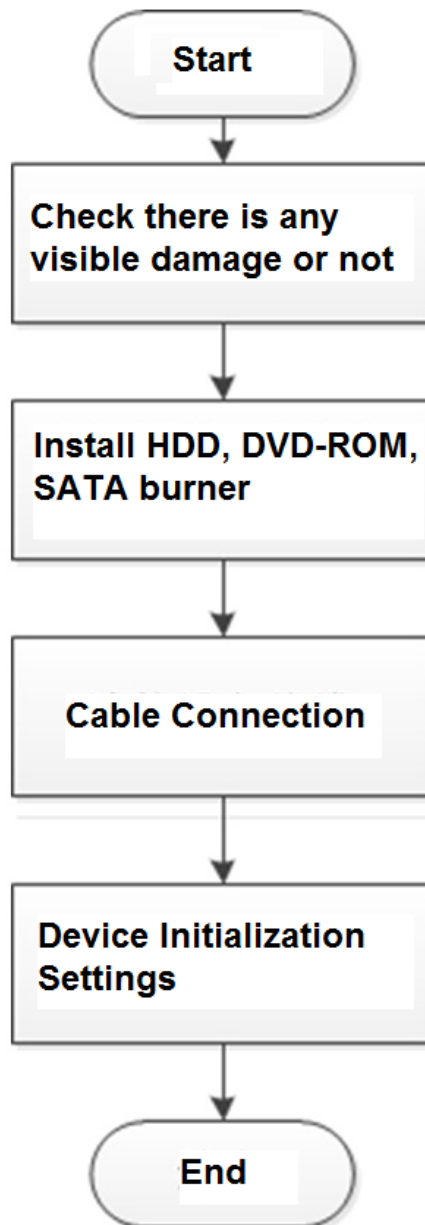

## 3.2 Check Unpacked NVR

When you receive the NVR from the forwarding agent, please check whether there is any visible damage. The protective materials used for the package of the NVR can protect most accidental clashes during transportation. Then you can open the box to check the accessories.

Please check the items in accordance with the list. Finally you can remove the protective film of the NVR.

## 3.3 About Front Panel and Rear Panel

The model number in the stick on the bottom of NVR is very important; please check according to your purchase order.

The label in the rear panel is very important too. Usually we need you to represent the serial number when we provide the service after sales.

## 3.4 HDD Installation

For the first time installation, make sure whether the HDD has been installed or not. We recommend to use HDD of enterprise level or surveillance level. It is not recommended to use PC HDD.



- Shut off the power before you replace the HDD.
- Use the dedicated SATA HDD for monitoring recommended by the HDD manufacturer.
- You can refer to the Appendix for HDD space information and recommended HDD brand.

### 3.4.1 1U Series

Step1 Remove the four fixing screws on the rear panel.

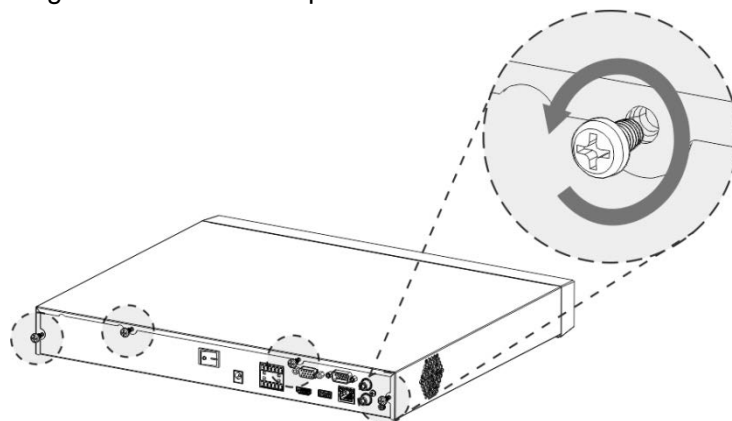

Figure 3-1

Step 1 Remove the case cover along the direction shown in the following arrow.

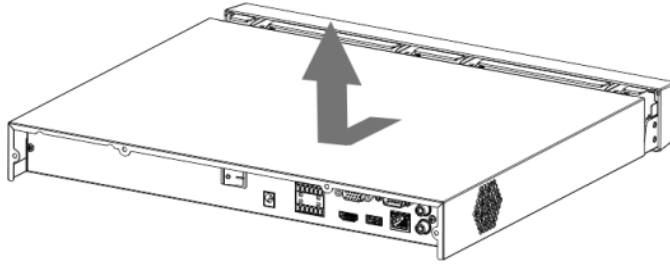

Figure 3-2

Step 2 Match the four holes on the baseboard to place the HDD.

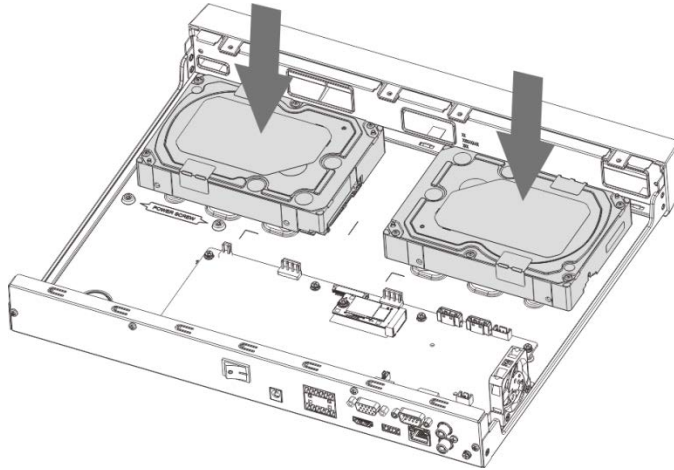

Figure 3-3

Step 3 Turn the device upside down, match the screws with the holes on the HDD and then fasten them. The HDD is fixed to the baseboard.

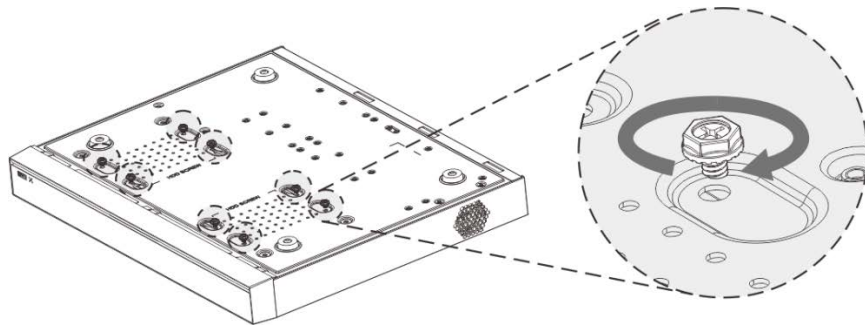

Figure 3-4

Step 4 Connect the HDD data cable and power cable to the device.

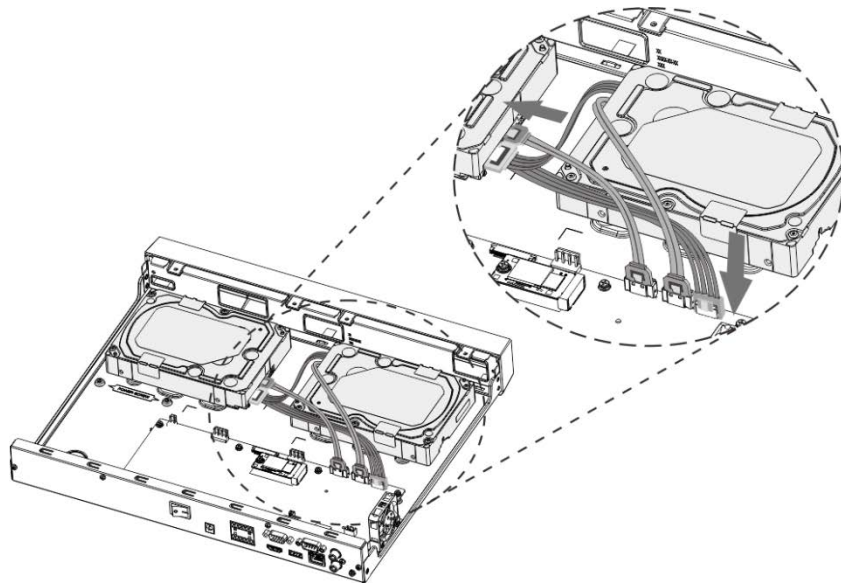

Figure 3-5

**Step 5** Put back the cover and fasten the four screws on the rear panel to complete the installation.

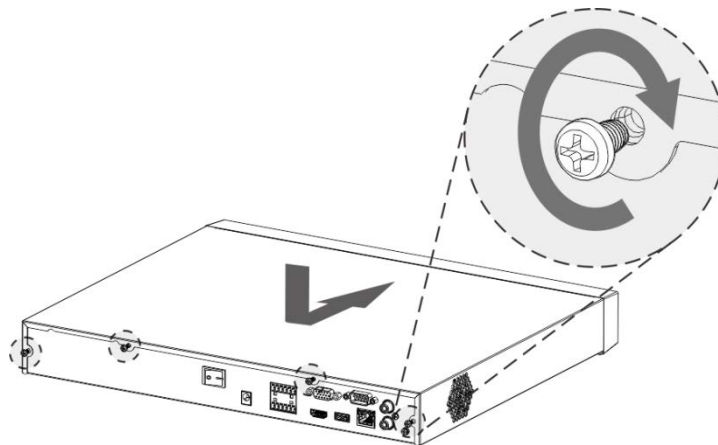

Figure 3-6

### 3.4.2 1.5U/2U Series

 NOTE

Different models have different HDD numbers. The actual product shall govern.

**Step 1** Remove the fixing screws on the rear panel of the device.

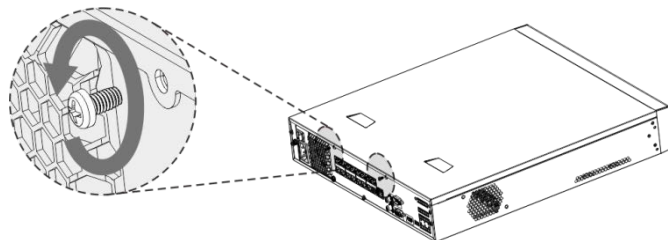

Figure 3-7

**Step 6** Remove the case cover along the direction shown in the following arrow.

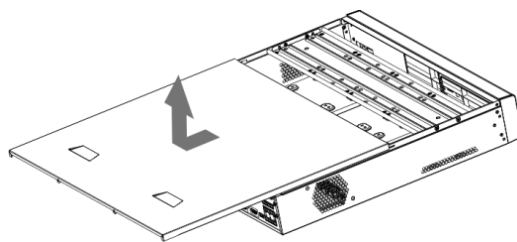

Figure 3-8

**Step 7** Remove the screws on the sides of HDD bracket to take out the bracket.

- 1.5U device has one HDD bracket. For the way to remove the bracket, see Figure 3-9
- 2U device has two HDD brackets. For the way to remove the brackets, see Figure 3-10.

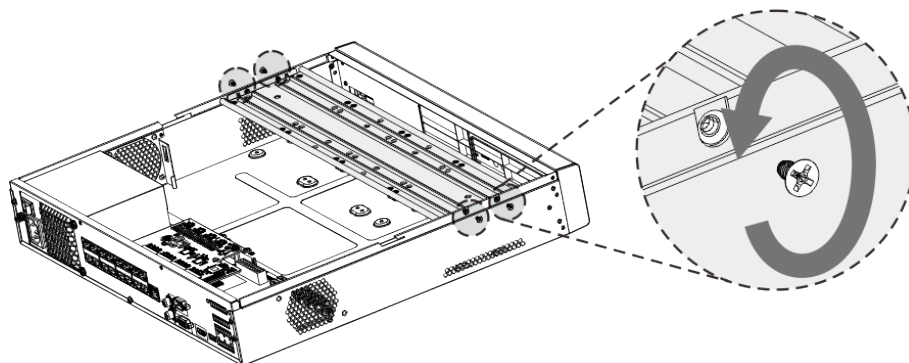

Figure 3-9

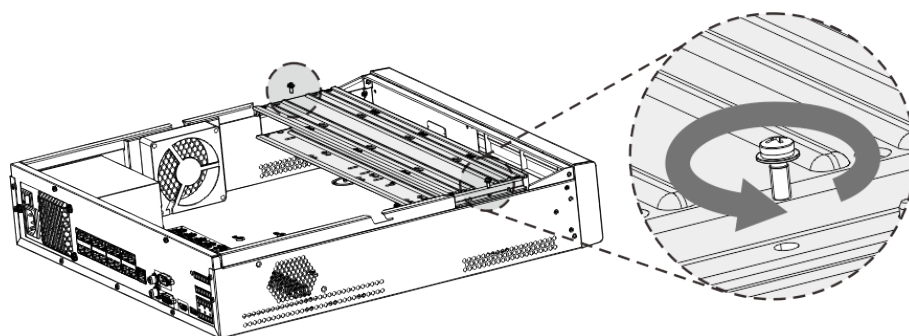

Figure 3-10

**Step 8** Match the four screw holes on the HDD with the four holes on the bracket and then fasten the screws. The HDD is fixed to the bracket.

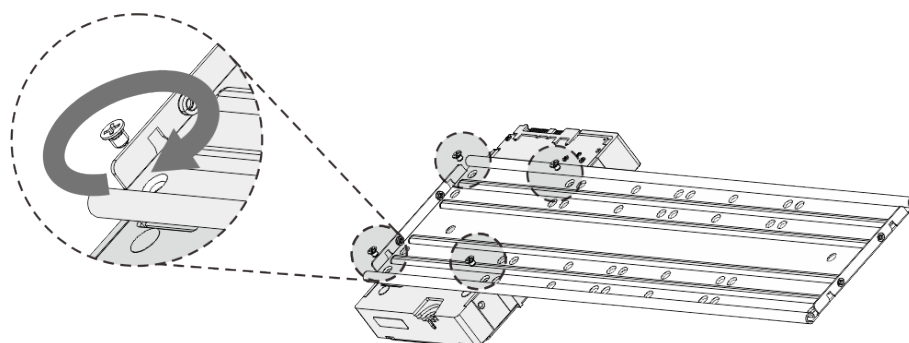

Figure 3-11

**Step 9** Refer to Step 4 to install other HDDs.

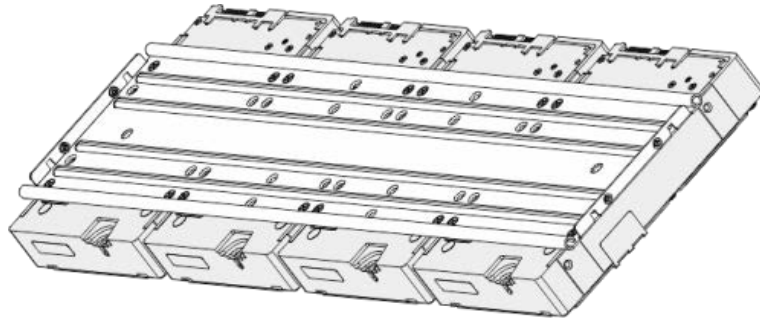

Figure 3-12

Step 10 Lock the two HDD brackets.



NOTE

This step is required for 2U devices only.

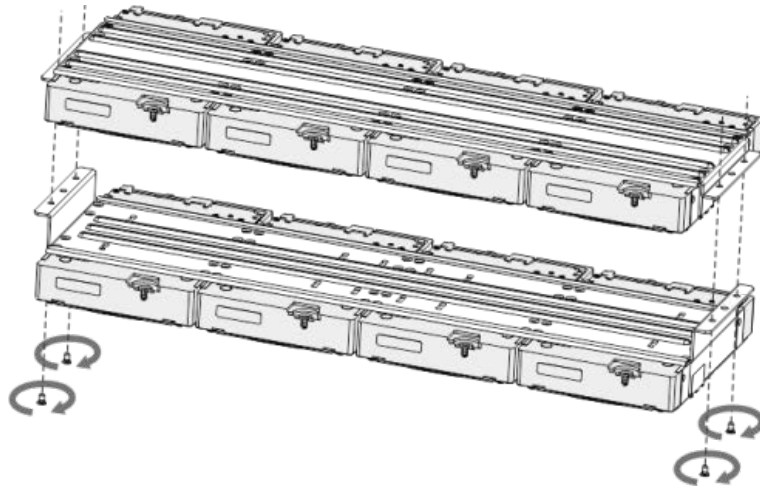

Figure 3-13

Step 11 Place the bracket to the device and then fasten the screws on the sides of the bracket.

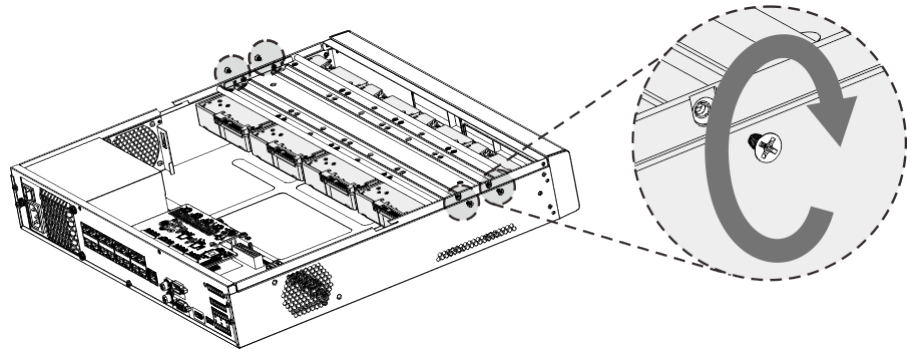

Figure 3-14

Step 12 Connect the HDD data cable and power cable to the device.



NOTE

The following figure is for reference only. The actual product shall govern.



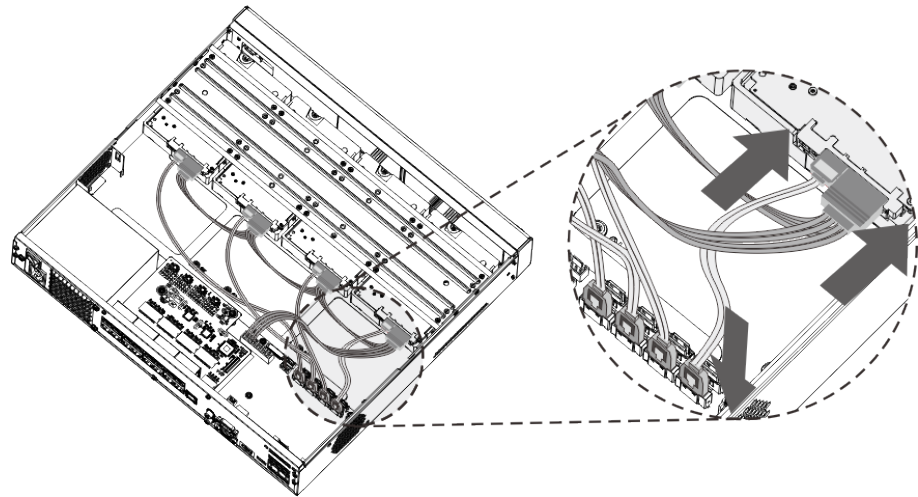

Figure 3-15

**Step 13** Put back the cover and fasten the screws on the rear panel to complete the installation.

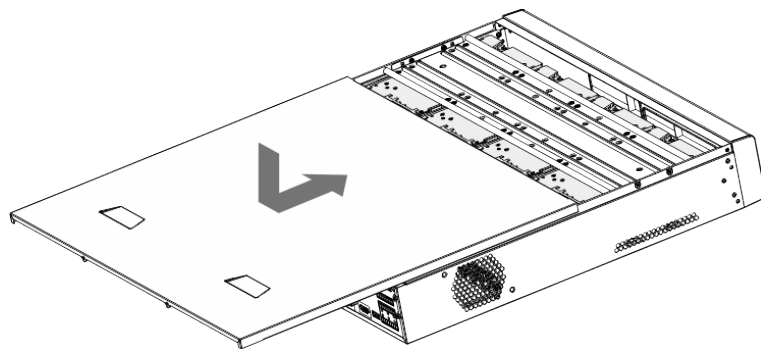

Figure 3-16

## 3.5 CD-ROM Installation

Please follow the steps listed below.



- ① Open top cover and then remove the HDD bracket
- ② Take off the bottom of the HDD bracket and CD-ROM bracket.



③ Fix the CD-ROM bracket at the HDD bracket.



④ Install a pair of the CD-ROM bracket. Please make sure the reverse side is secure too.



⑤ Install SATA burner. Line up the SATA burner to the hole positions.



⑥ User screwdriver to fix the screws.



⑦ Put the bracket back. Please adjust the CD-ROM to the proper position so that the button of the front panel is directly facing the pop-up button of the CD-ROM.

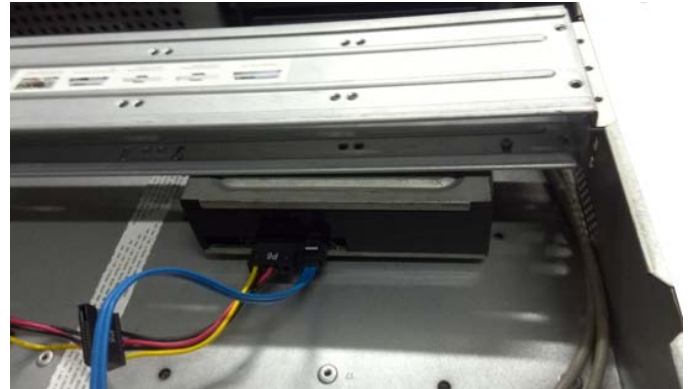

⑧ Connect the SATA cable and power wire.



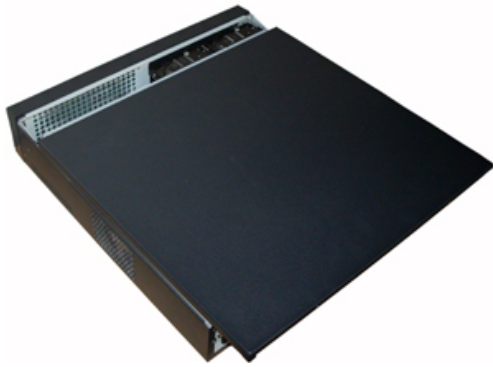

- ⑨ Secure the HDD bracket and put the top cover back.

## 3.6 Connection Sample

### 3.6.1 Advanced 2U 8HDD AI NVR/General 2U 8HDD AI NVR Series



NOTE

The following figure is for reference only. The actual product shall govern.

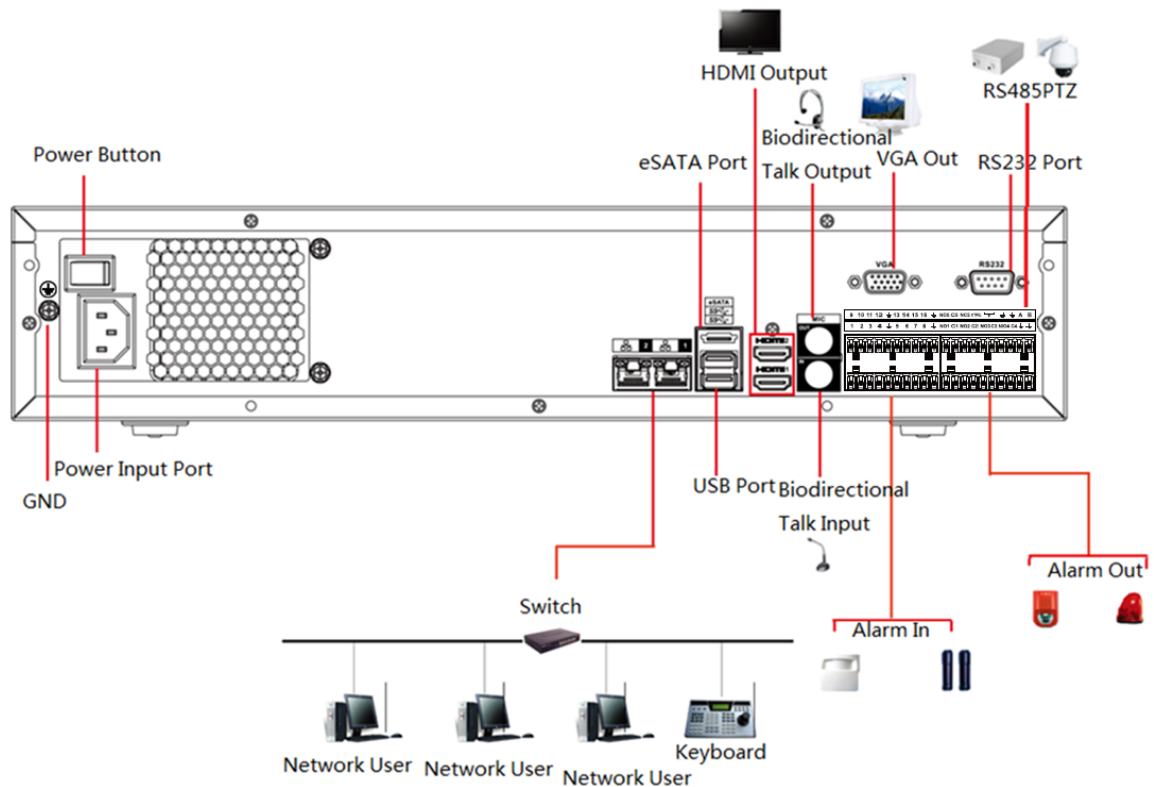

Figure 3-17

### 3.6.2 Advanced 1.5U 4HDD 16PoE AI NVR/General 1.5U 4HDD 16PoE AI NVR/General 1.5U 4HDD AI NVR Series

 NOTE

The following figure is for reference only. The actual product shall govern.

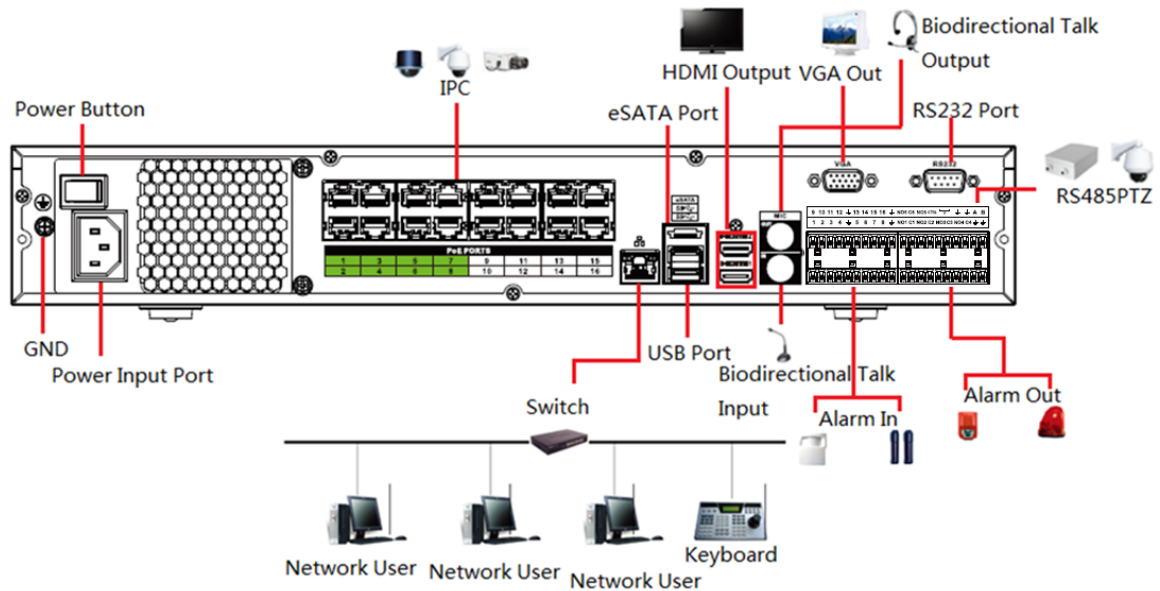

Figure 3-18

### 3.6.3 Advanced 1U 2HDD 16PoE AI NVR/General 1U 2HDD 16PoE AI NVR/Advanced 1U 2HDD 8PoE AI NVR/General 1U 2HDD 8PoE AI NVR/General 1U 2HDD AI NVR Series

 NOTE

The following figure is for reference only. The actual product shall govern.

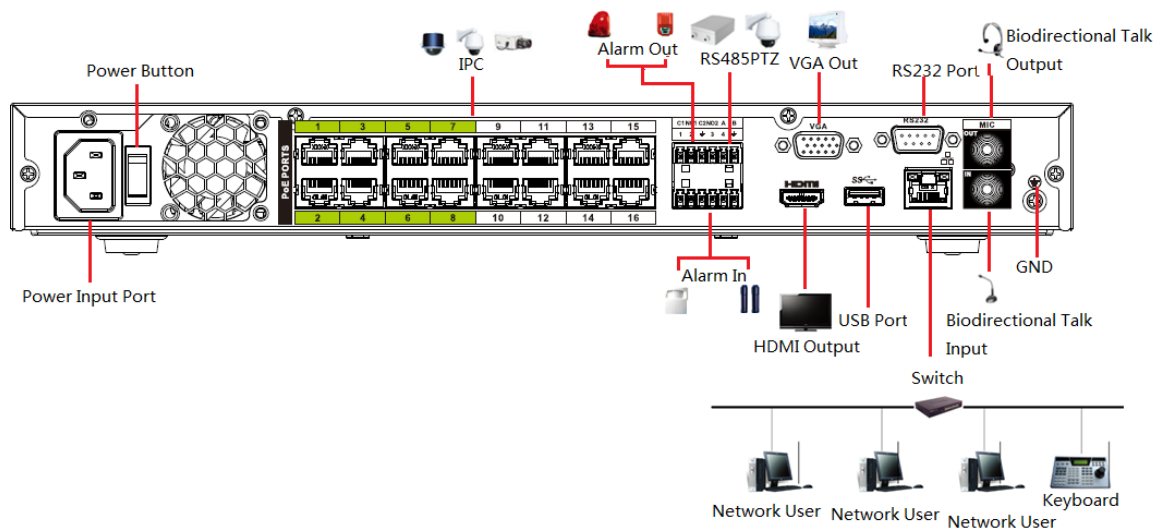

Figure 3-19

# 4 Local Basic Operation

## Note

Slight difference may be found on the user interface. The following figures for reference only.

## 4.1 Getting Started

### 4.1.1 Boot up and Shut down

#### 4.1.1.1 Boot up



Before the boot up, please make sure:

- For device security, please connect the NVR to the power adapter first and then connect the device to the power socket.
- The rated input voltage matches the device power on-off button. Please make sure the power wire connection is OK. Then click the power on-off button.
- Always use the stable current, if necessary UPS is a best alternative measure.

Please follow the steps listed below to boot up the device.

Step 1 Connect the device to the monitor and then connect a mouse.

Step 2 Connect power cable.

Step 3 Click the power button at the front or rear panel and then boot up the device. After device booted up, the system is in multiple-channel display mode by default.

#### 4.1.1.2 Shutdown

## Note

- When you see corresponding dialogue box “System is shutting down...” Do not click power on-off button directly.
- Do not unplug the power cable or click power on-off button to shutdown device directly when device is running (especially when it is recording.)

There are three ways for you to log out.

- a) Main menu (**RECOMMENDED**)

From Main Menu > Shutdown, select shutdown from dropdown list.

Click OK button, you can see device shuts down.

- b) From power on-off button on the front panel or remote control.

Press the power on-off button on the NVR front panel or remote control for more than 3 seconds to shut down the device.

- c) From power on-off button on the rear panel.

## 4.1.2 Device Initialization

If it is your first time to use the device, please set a login password of **admin** (system default user). You can select to use unlock pattern to login or not at your own choosing.

### Note

For your device safety, please keep your login password of **admin** well after the initialization steps, and change the password regularly.

Please follow the steps listed below.

Step 1 Boot up NVR.

Device displays device initialization interface. See Figure 4-1.

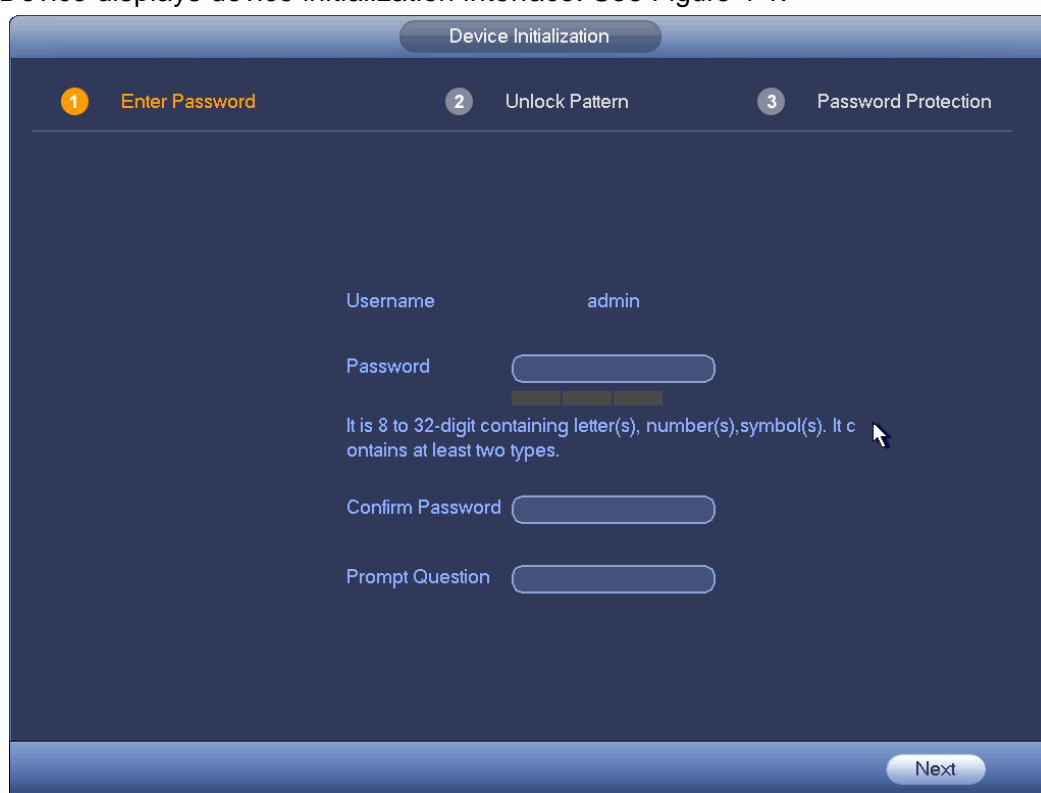



Figure 4-1

Step 2 Set login password of **admin**.

- User name: The default user name is **admin**.
- Password/confirm password: The password ranges from 8 to 32 digitals. It can contain letters, numbers and special characters (excluding “”, “”, “”, “:”, “&”) . The password shall contain at least two categories. Usually we recommend the strong password.
- Prompt question: If you set the prompt question here. On the login interface, move your mouse on , device can display the corresponding prompt question for you to remind the password.



**STRONG PASSWORD RECOMMENDED**-For your device own safety, please create a strong password of your own choosing. We also recommend you change your password periodically especially in the high security system.

Step 3 Click Next, device goes to the following interface. See Figure 4-2.

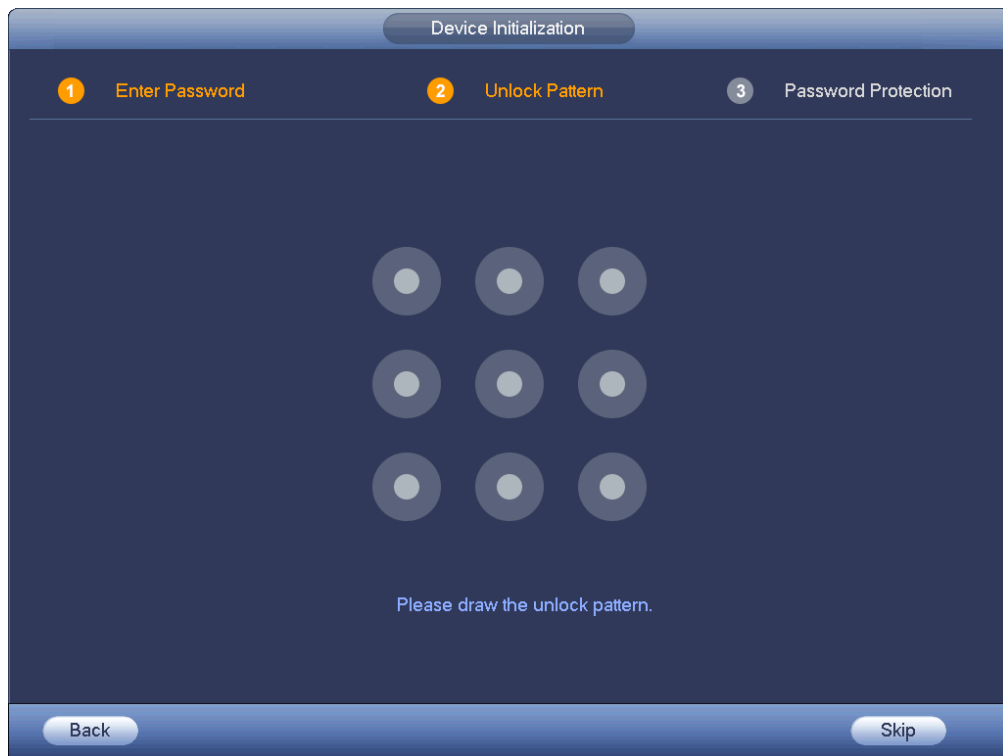

Figure 4-2

Step 4 Set unlock pattern.

After set unlock pattern, device goes to password protection interface. See Figure 4-3.

 **Note**

- Device adopts unlock pattern to login by default if you have set pattern here. If there is no unlock pattern, please input the password to login.
- Click Skip if there is no need to set unlock pattern.

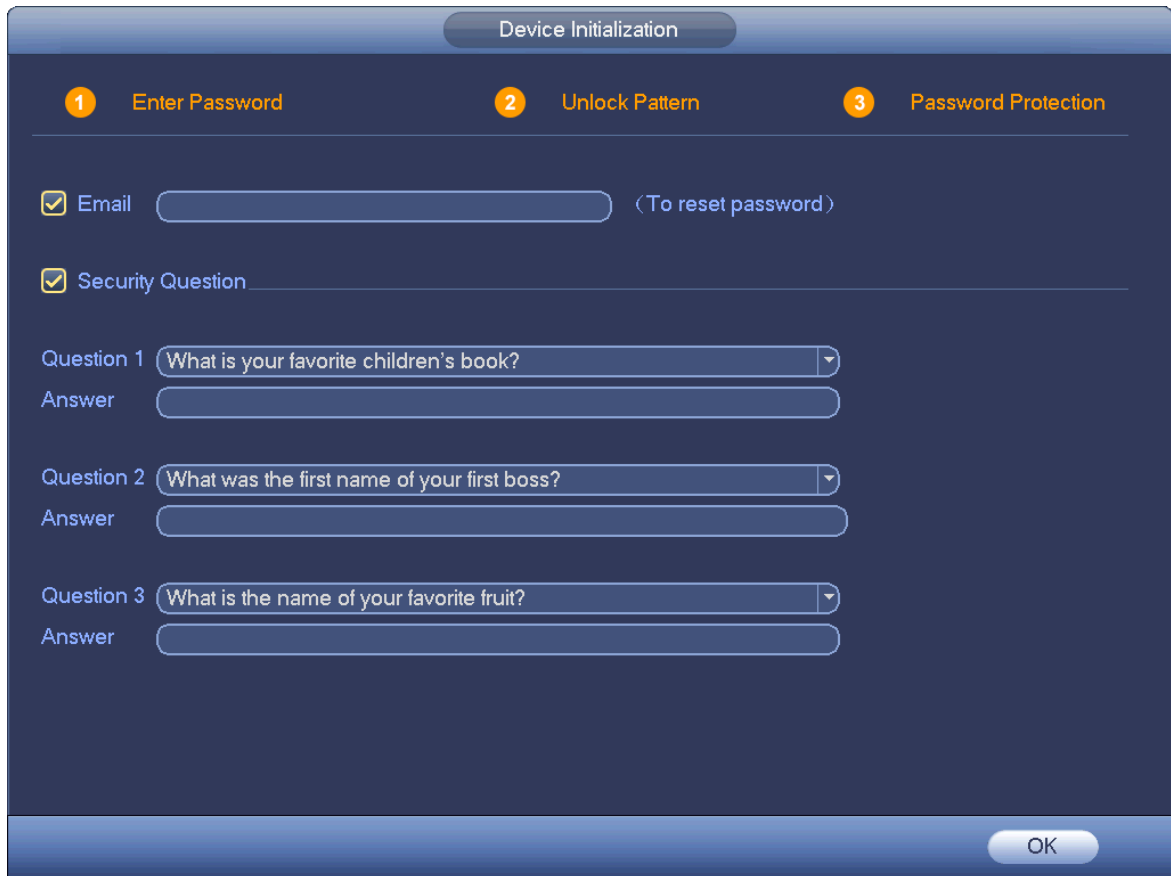

Figure 4-3

Step 5 Set security questions.

 **Note**

- After setting the security questions here, you can use the email you input here or answer the security questions to reset **admin** password. Refer to chapter 4.1.3 Reset password for detailed information.
- Cancel the email or security questions box and then click Next button to skip this step.
- Email: Input an email address for reset password purpose. In case you forgot password in the future, input the security code you got on the assigned email to reset the password of admin. If you have not input email here or you need to update the email information, please go to the main menu>Setting>System>Account to set. Refer to chapter 4.10.1 Account for detailed information.
- Security question: Set security questions and corresponding answers. Properly answer the questions to reset admin password. In case you have not input security question here or you need to update the security question information, please go to the main menu>Setting>System>Account>Security question to set. Refer to chapter 4.10.1.3 Security question for detailed information.

 **Note**

If you want to reset password by answering security questions, please go to the local menu interface.

Step 6 Click OK to complete the device initialization setup.  
Device goes to startup wizard interface. Refer to chapter 4.1.4 Quick Settings for detailed information.

### 4.1.3 Reset Password

If you forgot the admin password, you can reset the password by the following ways:

- When the password reset function is enabled, you can scan the QR code on the local interface to reset the password.
- When the password reset function is disabled, you can reset password via the security questions configured before. If the security questions are not configured, system displays that Password reset is closed! You need to contact the customer service for help.

Step 1 Go to the device login interface. See Figure 4-4 or Figure 4-5. .

- If you have set unlock pattern, device displays unlock pattern login interface. See Figure 4-4. Click “Forgot unlock pattern”, device goes to Figure 4-5.
- If you have not set unlock pattern, device displays password interface. See Figure 4-5.

#### Note

Click Switch user button, NVR goes to general user login interface. The default user name is **admin**.  
Click the user name and then select a user from the dropdown list; you can login via other account.

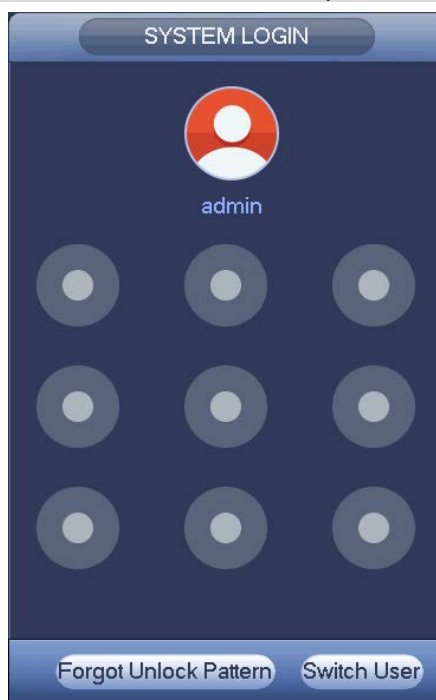

Figure 4-4



Figure 4-5

Step 2 Click .

- If you have not input email address information when you are initializing the device, the interface is shown as in Figure 4-6. Please input an email address and then click Next button, devices goes to Figure 4-7.
- If you have input email when you are initializing the device, device goes to Figure 4-7.

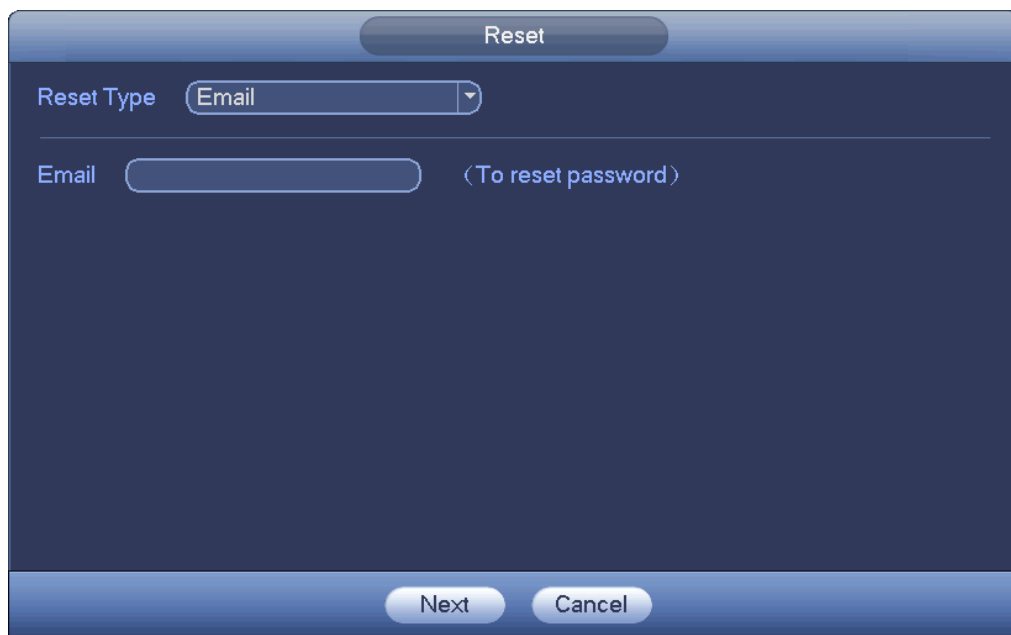

Figure 4-6





Figure 4-7

Step 3 Reset login password.

There are two ways to reset the password: Scan QR code and reset by email/security questions (local menu only)

- Email

In Figure 4-7, follow the prompts on the interface to scan the QR code, and then input the security code you get via the assigned email.



**CAUTION**

- ◇ For the same QR code, max scan twice to get two security codes. Refresh the QR code if you want to get security code again.
- ◇ The security code on your email is only valid for 24 hours.

- Security questions

In Figure 4-6., select security question from the drop down list. Device displays security question interface. See Figure 4-8. Please input the correct answers here.

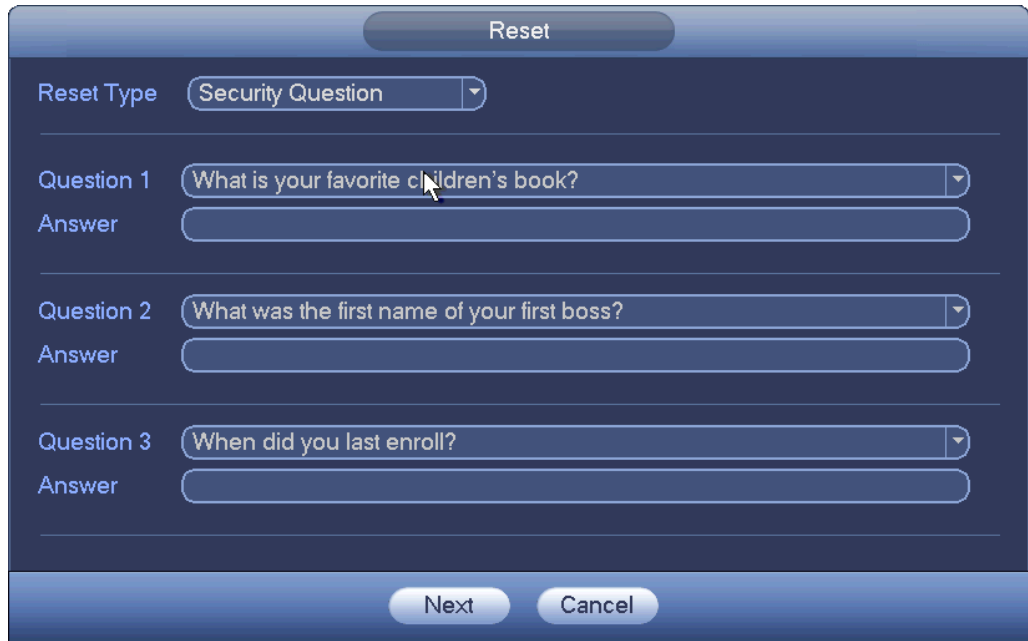

Figure 4-8

Step 4 Click Next button.

Device displays reset password interface. See Figure 4-9.

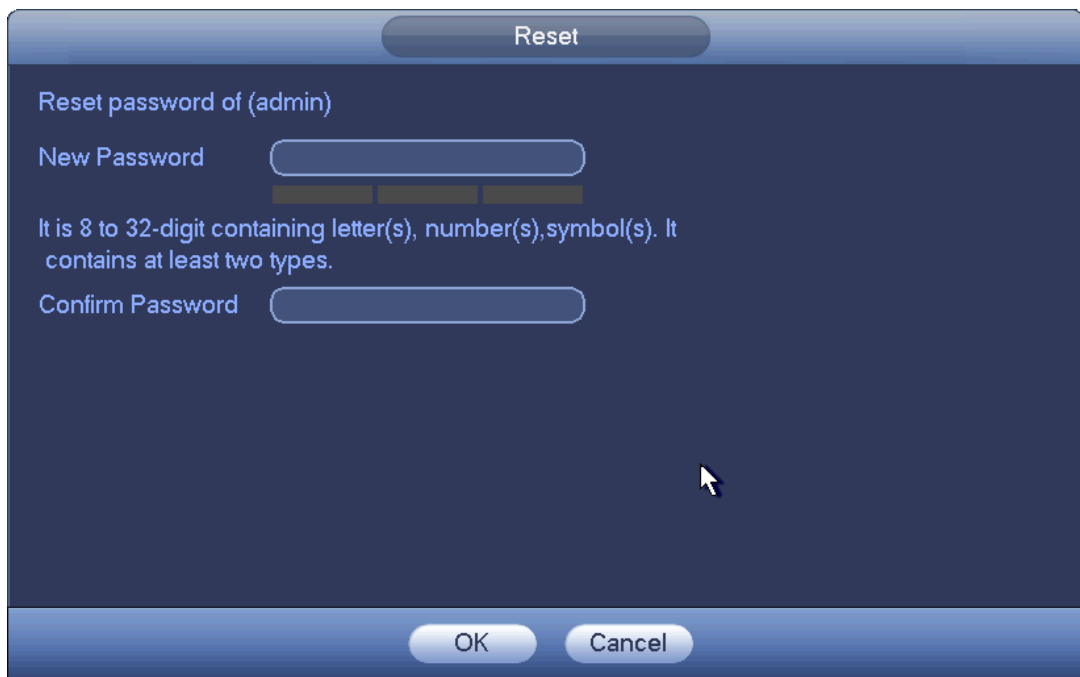

Figure 4-9

Step 5 Input new password and then confirm.



**CAUTION**

**STRONG PASSWORD RECOMMENDED**-For your device own safety, please create a strong password of your own choosing. The password shall be at least 8-digit containing at least two types of the following categories: letters, numbers and symbols. We also recommend you change your password periodically especially in the high security system.

Step 6 Click OK button to complete the setup.

## 4.1.4 Quick Settings

After you successfully initialize the device, it goes to startup wizard. Here you can quickly configure your device. It includes general setup, basic network setup, camera registration, P2P, and schedule interface.

### Note

- Once the power is off during the quick settings process, you need to go through startup wizard again when the device boot up the next time.
- After completing all items on the startup wizard, the startup wizard automatically hides when the device boot up the next time.

Please follow the steps listed below.

Boot up the device and complete the device initialization. Device goes to startup wizard. See Figure 4-10.

- Select auto check for updates, device automatically checks if there is new applications or not every day.

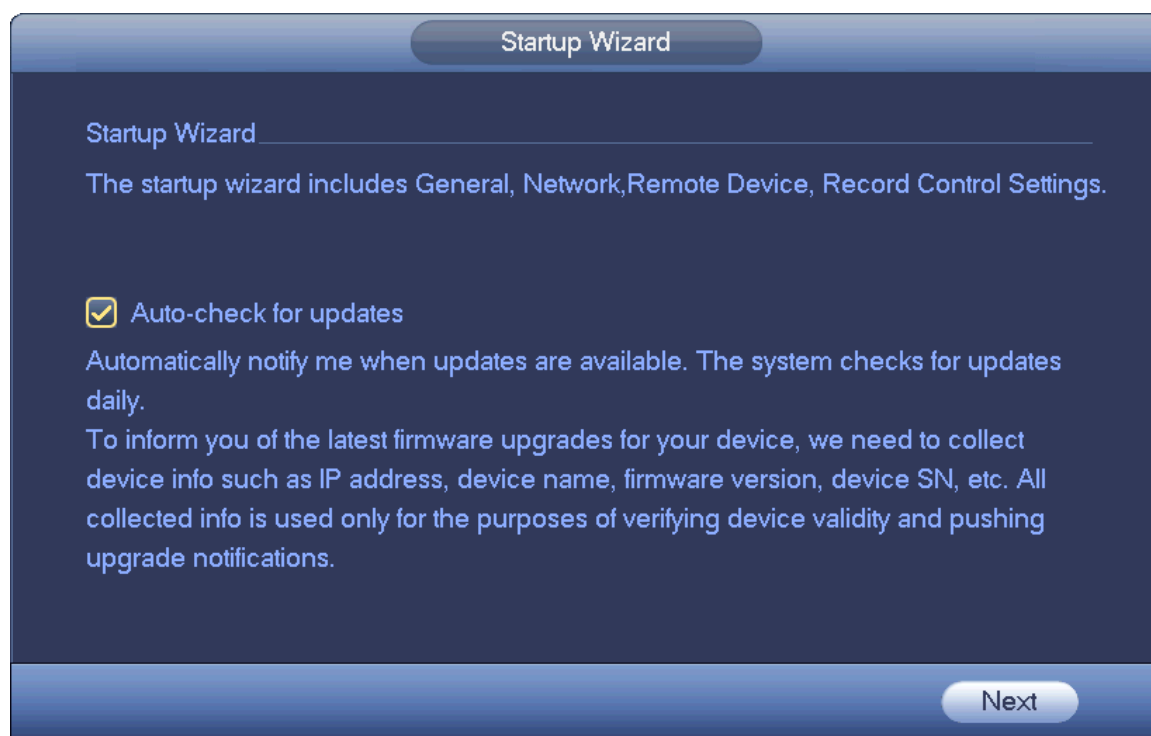

Figure 4-10

### 4.1.4.1 General

It is to set NVR basic information such as system date, holiday and etc.

#### 4.1.4.1.1 General

It is to set device basic information such as device name, serial number and etc.

Please follow the steps listed below.

Step 1 Click Next button,

Enter General interface.

Step 2 Click General button.

The interface is shown as below. See Figure 4-11.



### Note

From Main menu > Setting > System > General > General, you can go to the general interface.

Step 3 Set parameters.

- Device ID: Please input a corresponding device name here.
- Device No: When you are using one remote control (not included in the accessory bag) to control several NVRs, you can give a name to each NVR for your management.
- Language: System supports various languages: Chinese (simplified), Chinese (Traditional), English, Italian, Japanese, French, Spanish (All languages listed here are optional. Slight difference maybe found in various series.)
- Video standard: There are two formats: NTSC and PAL.
- HDD full: Here is for you to select working mode when hard disk is full. There are two options: stop recording or rewrite old files.
- Pack duration: Here is for you to specify record duration. The value ranges from 1 to 120 minutes. Default value is 60 minutes.
- Realtime play: It is to set playback time you can view in the preview interface. The value ranges from 5 to 60 minutes.
- Auto logout: Here is for you to set auto logout interval once login user remains inactive for a specified time. Value ranges from 0 to 60 minutes.
- Monitor channels when logout: Here you can set channels you want to view when your account has logged out. Click the button and then cancel the channel name box, you need to login to view the corresponding video. The channel window displays  in preview interface.
- Navigation bar: Check the box here, system displays the navigation bar on the interface.
- IPC Time Sync: You can input an interval here to synchronize the NVR time and IPC time.
- Startup wizard: Once you check the box here, system will go to the startup wizard directly when the system restarts the next time. Otherwise, it will go to the login interface.
- Mouse sensitivity: You can set double click speed via dragging the slide bard. You can Click Default button to restore default setup.



Figure 4-11

Step 4 Click Apply button to save settings.

#### 4.1.4.1.2 Date and Time

Here you can set device time. You can enable NTP (Network Time Protocol) function so that the device can sync time with the NTP server.

Step 1 Click Date and time button. See Figure 4-12.

#### Note

From Main menu>Setting>System>General>Date and time, you can go to the date and time interface.

- System time: Here is for you to set system time
- Date format: There are three types: YYYY-MM-DD: MM-DD-YYYYY or DD-MM-YYYY.
- Date separator: There are three denotations to separate date: dot, beeline and solidus.
- DST: Here you can set DST time and date by week or by date. Please enable DST function and then select setup mode. Please input start time and end time and click Save button.
- Time format: There are two types: 24-hour mode or 12-hour mode.
- NTP: It is to set NTP server, port and interval.

#### CAUTION

- ✧ System time is very important; do not modify time casually unless there is a must!
- ✧ Before your time modification, please stop record operation first!



Figure 4-12

Step 2 Click Apply button to save settings.

#### 4.1.4.1.3 Holiday

Here you can add, edit, delete holiday. After you successfully set holiday information, you can view holiday item on the record and snapshot period.

Step 1 Click Holiday button. See Figure 4-13.

#### Note

From Main menu > Setting > System > General > Holiday, you can go to the holiday interface.

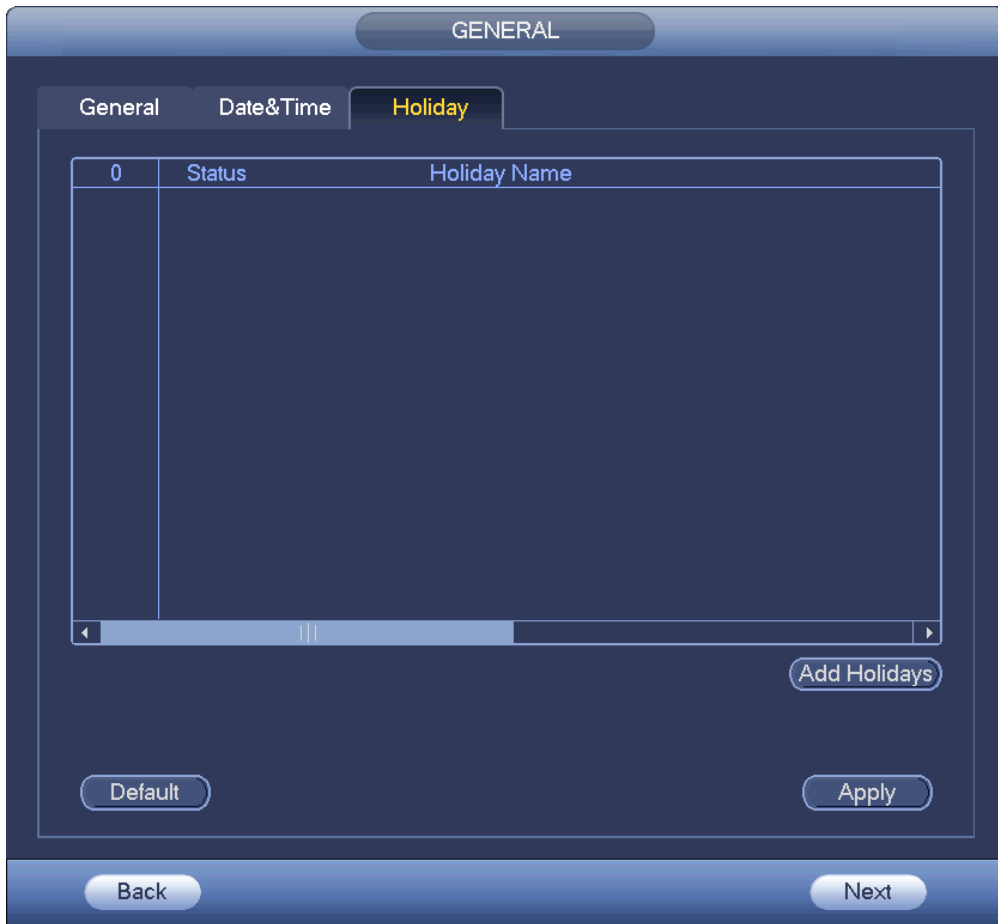

Figure 4-13

Step 2 Click Add new holiday button, device displays the following interface. See Figure 4-14.

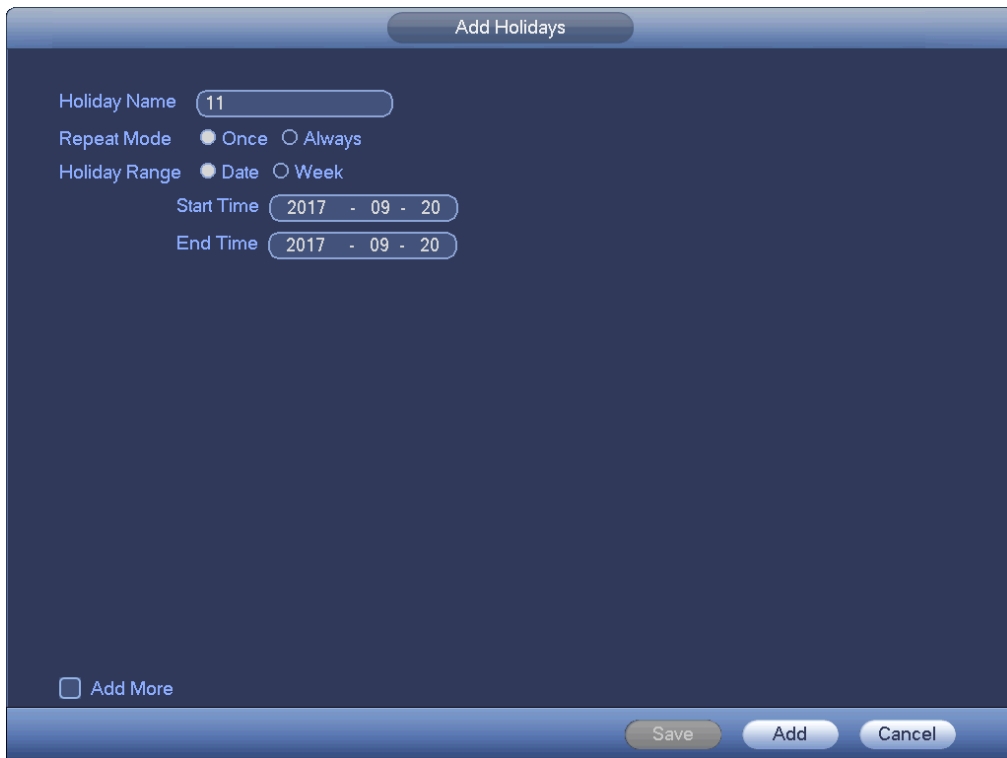

Figure 4-14

Step 3 Set holiday name, repeat mode and holiday mode.

 **Note**

Click Add more to add new holiday information.

Step 4 Click Add button, you can add current holiday to the list.

 **Note**

✧ Click the dropdown list of the state; you can enable/disable holiday date.

✧ Click  to change the holiday information. Click  to delete current date.

Step 5 Click Apply button to save settings.

## 4.1.4.2 Basic Network Settings

Set device IP address, DNS (Domain Name System) information.

### Preparation

Make sure the device has properly connected to the network.

Step 1 Click Next button, device goes to TCP/IP interface.

 **Note**

✧ From Main menu>Setting>Network>TCP/IP, you can go to the TCP/IP interface.

✧ Different series products have different Ethernet adapter amount and type. Please refer to the actual product.

Step 2 Click , device display edit interface.

Step 3 Set parameters.

- Network Mode: Includes multiple access, fault tolerance, and load balancing
- ✧ Multiple-address mode: eth0 and eth1 operate separately. You can use the services such as HTTP, RTP service via etho0 or the eth1. Usually you need to set one default card (default setup is etho) to request the auto network service form the device-end such as DHCP, email, FTP and etc. In multiple-address mode, system network status is shown as offline once one card is offline.
- ✧ Network fault-tolerance: In this mode, device uses bond0 to communicate with the external devices. You can focus on one host IP address. At the same time, you need to set one master card. Usually there is only one running card (master card). System can enable alternate card when the master card is malfunction. The system is shown as offline once these two cards are both offline. Please note these two cards shall be in the same LAN.
- ✧ Load balance: In this mode, device uses bond0 to communicate with the external device. The eth0 and eth1 are both working now and bearing the network load. Their network load are general the same. The system is shown as offline once these two cards are both offline. Please note these two cards shall be in the same LAN.
- Main Network Card: Please select eth0/eth1 (optional).after enable multiple access function.

 **Note**



The dual-Ethernet port series support the above three configurations and supports functions as multiple-access, fault-tolerance and load balancing.

- MAC address: The host in the LAN can get a unique MAC address. It is for you to access in the LAN. It is read-only.
- IP address: Here you can use up/down button (▲▼) or input the corresponding number to input IP address. Then you can set the corresponding subnet mask the default gateway.
- Default gateway: Here you can input the default gateway. Please note system needs to check the validity of all IPv6 addresses. The IP address and the default gateway shall be in the same IP section. That is to say, the specified length of the subnet prefix shall have the same string.
- DHCP: It is to auto search IP. When enable DHCP function, you cannot modify IP/Subnet mask /Gateway. These values are from DHCP function. If you have not enabled DHCP function, IP/Subnet mask/Gateway display as zero. You need to disable DHCP function to view current IP information. Besides, when PPPoE is operating, you cannot modify IP/Subnet mask /Gateway.
- MTU: It is to set MTU value of the network adapter. The value ranges from 1280-7200 bytes. The default setup is 1500 bytes.
- Transfer mode: Here you can select the priority between fluency/video qualities.

Step 4 Click OK to NIC settings.  
Device goes back to TCP/IP interface.

 **Note**

Click  to cancel NIC bonding. Please note device needs to reboot to activate new setup.

Step 5 Set network parameters.

- IP Version: There are two options: IPv4 and IPv6. Right now, system supports these two IP address format and you can access via them.
- Preferred DNS server: DNS server IP address.
- Alternate DNS server: DNS server alternate address.
- Default Network Card: Please select eth0/eth1/bond0(optional) after enable multiple-access function.
- LAN download: System can process the downloaded data first if you enable this function. The download speed is 1.5X or 2.0X of the normal speed.

 **Note**

- For IPv6 version, the IP address, default gateway, preferred DNS; alternate DNS is 128-digit. Please fill in all items here.
- This function is for some series product only.

Step 6 Click Next to complete the settings.

### 4.1.4.3 P2P

Click Next button, you can set P2P function. Scan the QR code, download the App to the cell phone, you can use the smart phone to add the device.

- Scan the QR code on the actual interface to download the cell phone app. Register an account and then use.

- Go to the [www.easy4ip.com](http://www.easy4ip.com) to register an account and use the SN to add a device. Refer to the P2P operation manual for detailed information.



### Warning

Before use the P2P function, make sure the NVR has connected to the WAN.

Please follow the steps listed below.

Step 1 Click Next button.

Enter P2P interface. See Figure 4-17.



### Note

From main menu>Setting>Network>P2P, you can go to P2P interface.



Figure 4-15

Step 2 Check the box to enable P2P function.

Step 3 Click Next button to complete setup.

The status is online if the P2P registration is successful.

### Client Operation

Please follow the steps listed below.

Step 1 Use the cell phone to scan the QR code on the interface and then download and install the cell phone app.



Step 2 Open App; tap  to go to the Live preview.

Step 3 Tap  at the top left corner, you can see the main menu.

Step 4 Tap Device manager button, you can use several modes (P2P/DDNS/IP and etc.) to add the device. Click  to save current setup. Tap Start Live preview to view all-channel video from the connected device. See Figure 4-18.

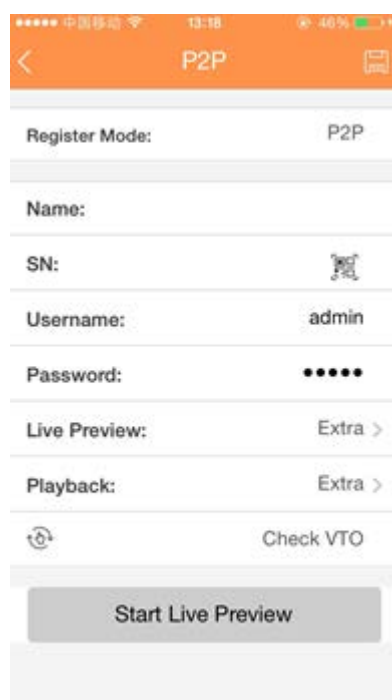

Figure 4-16

Step 5 Click Start live preview to view real-time video.

#### 4.1.4.4 Registration

After add remote device, the device can receive, store, and manage the video streams of the remote device. You can view, browse, play back and manage several remote devices at the same time.

Step 1 On the P2P interface, click Next button.



Enter Registration interface. See Figure 4-19.



##### Note

There are two ways to go to Registration interface.

- From main menu > Setting > Camera > Registration, you can go to the registration interface.
- On the preview interface, right click mouse and then select Camera Registration.

Step 2 Set parameters

- Channel: It is the device channel number. If you have not added the network camera, the channel number is shown as .
- Status: Red circle () means current channel has no video, green circle () means current channel has video.
- IP address: It is to display network camera IP address.

- Add/Delete: Click  to delete the device, click  to add the device to the NVR.
- Step 3 Add network camera.

- Device search: Click the button; you can search all network cameras in the same network segment. See Figure 4-20. Double click a camera or check the camera box and then click Add button, you can add a device to the list.

 **Note**

The device in the added device list is not shown in the search result column.

- Manual Add: Click Manual Add button, you can set the corresponding network camera information and then select the channel you want to add. See Figure 4-21.
  - ◇ Manufacturer: Please select from the dropdown list.

 **Note**

Different series products may support different manufactures, please refer to the actual product.

- ◇ IP address: Input remote device IP address.
- ◇ RTSP port: Input RTSP port of the remote device. The default setup is 554.

 **Note**

Skip this item if the manufacture is private or customized.

- ◇ HTTP port: Input HTTP port of the remote device. The default setup is 80.

 **Note**

Skip this item if the manufacture is private or customized.

- ◇ TCP port: Input TCP port of the remote device. The default setup is 37777.
- ◇ User name/password: The user name and password to login the remote device.
- ◇ Channel No.: Input channel amount or click the Connect button to get the channel amount of the remote device.

 **Note**

We recommend click Connect button to get remote device channel amount, the manual add operation may result in failure if the input channel amount is not right.

- ◇ Remote channel No.: After getting the remote device channel amount, click Setup to select a channel.

 **Note**

Click to select one or more remote channel numbers here.

- ◇ Channel: The local channel number you want to add. One channel name has corresponding one channel number.
- ◇ Decode buffer: There are three items: realtime,local,fluent.
- ◇ Service type: There are four items: auto/TCP/UDP/MULTICAST(ONVIF device only)

 **Note**

- ◇ The default connection mode is TCP if the connection protocol is private.
- ◇ There are three items: TCP/UDP/MULTICAST if the connection protocol is ONVIF.
- ◇ There are two items: TCP/UDP if the connection protocol is from the third-party.



Figure 4-17

Step 4 Click OK to add the camera to the device.

 **Note**

Click  to change the remote device information. Click  to delete remote device. .

### 4.1.4.5 Schedule

After set record schedule and snapshot schedule, the device can automatically record video and snapshot image at the specified time.

#### 4.1.4.5.1 Schedule Record

After set schedule record, device can record video file according to the period you set here. For example, the alarm record period is from 6:00–18:00 Monday, device can record alarm video files during the 6:00–18:00.

All channels are record continuously by default. You can set customized record period and record type.

Step 1 Click Next button.

Enter schedule interface. See Figure 4-22.

 **Note**

From main menu > Setting > Storage > Schedule > Record, you can go to the record interface.



Figure 4-18

Step 2 Set parameters.

- Channel: Please select the channel number first. You can select “all” if you want to set for the whole channels.

✧ : Sync connection icon. Select icon  of several dates, all checked items can be edited or together. Now the icon is shown as .

- ✧ : Click it to delete a record type from one period.
- Record Type: Please check the box to select corresponding record type. There are six types: Regular/MD (motion detect)/Alarm/MD&Alarm/IVS/POS.
- Week day: There are eight options: ranges from Saturday to Sunday and all.
- Holiday: It is to set holiday setup. Please note you need to go to the General interface (Main Menu>Setting>System>General) to add holiday first. Otherwise you cannot see this item.
- Pre-record: System can pre-record the video before the event occurs into the file. The value ranges from 1 to 30 seconds depending on the bit stream.
- Redundancy: System supports redundancy backup function. It allows you backup recorded file in two disks. You can highlight Redundancy button to activate this function. Please note, before enable this function, please set at least one HDD as redundant. (Main menu>Setting>Storage>HDD Manager). Please note this function is null if there is only one HDD.

- ANR: It is to save video to the SD card of the network camera in case the network connection fails. The value ranges from 0s–43200s. After the network connection resumed, the system can get the video from the SD card and there is no risk of record loss.



- Period setup: Click button  after one date or a holiday, you can see an interface shown as in Figure 4-23. There are five record types: regular, motion detection (MD), Alarm, MD & alarm and IVS.



Figure 4-19

Please following the steps listed below to draw the period manually.

- Step 1 Select a channel you want to set. See Figure 4-24.



Figure 4-20

- Step 2 Set record type. See Figure 4-25.



Figure 4-21

 **Note**

- When the record type is MD (motion detect), alarm, MD&Alarm, IVS and POS, please enable the channel record function when corresponding alarm occurs. For example, when the alarm type is MD, from main menu>Setting>Event>Video Detect>Motion Detect, please select the record channel and enable record function. See Figure 4-26.

- When the record type is MD (motion detect), alarm, MD&Alarm, IVS and POS, refer to chapter 4.7.1 Video detect, chapter 4.7.11 Alarm Settings, chapter 4.7.3 IVS and chapter 4.7.14 POS.

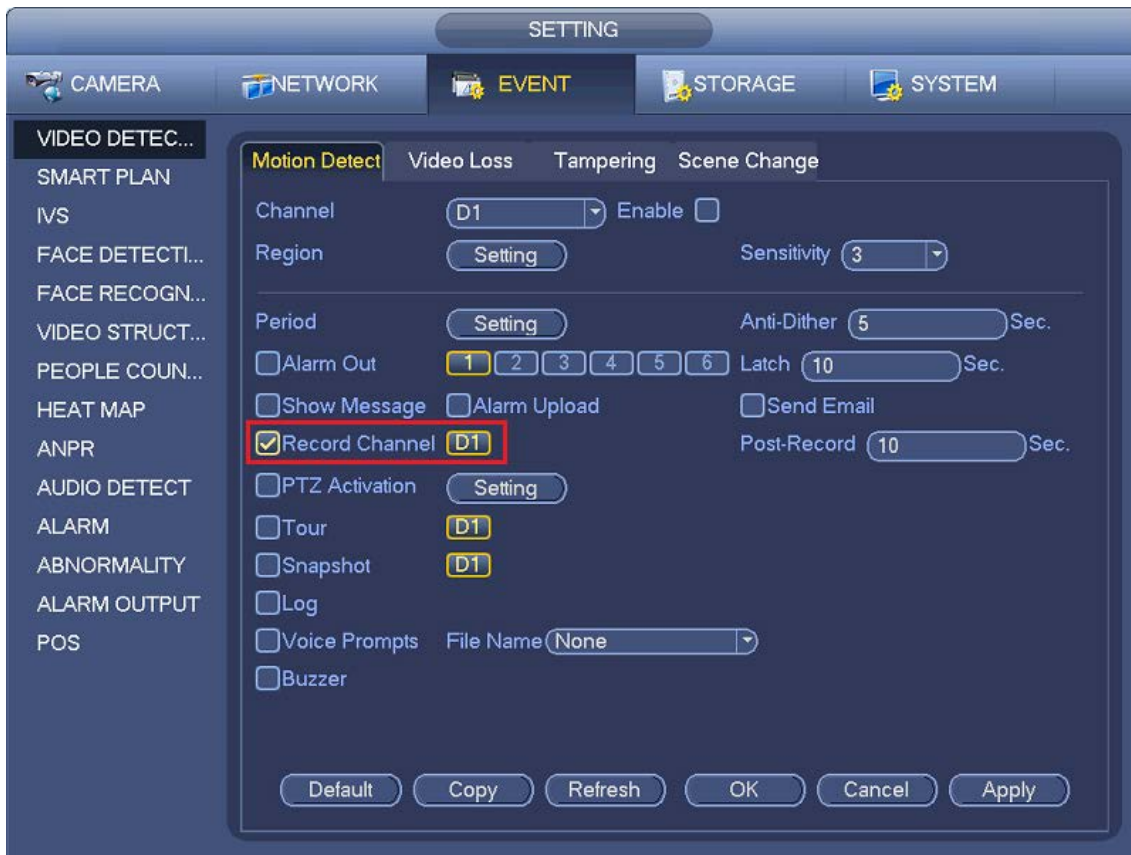

Figure 4-22

Step 3 Please draw manually to set record period. There are six periods in one day. See Figure 4-27.

**Note**

If you have added a holiday, you can set the record period for the holiday.

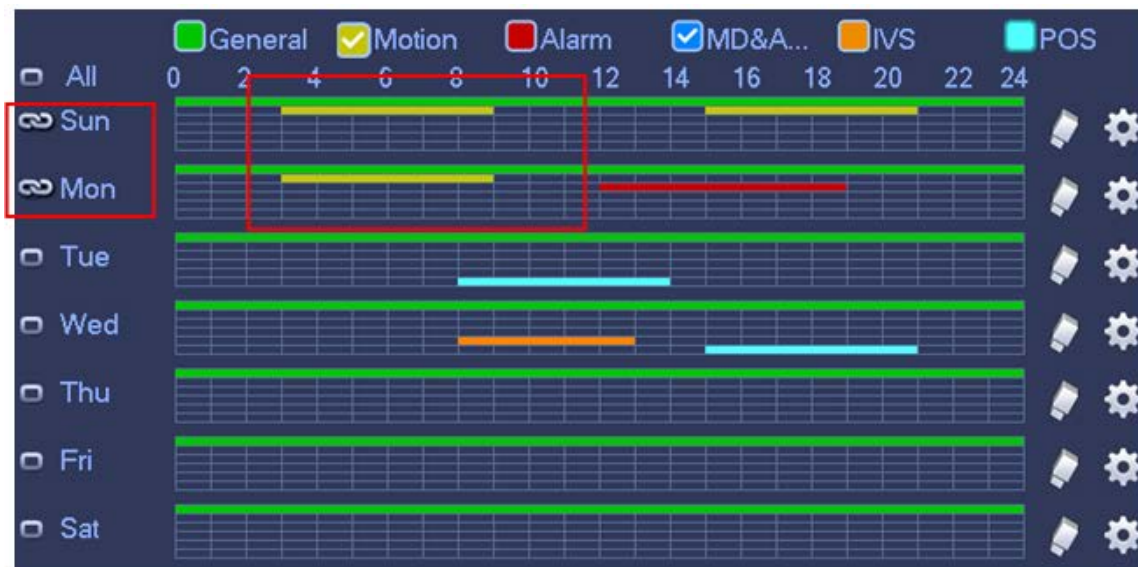

Figure 4-23



Step 4 Click Apply button to save schedule record settings.

 **Note**

Please enable auto record function so that the record plan can become activated. Refer to chapter 4.1.4.5.3 Record control for detailed information.

#### 4.1.4.5.2 Schedule Snapshot

It is to set schedule snapshot period.

After set schedule snapshot, device can snapshot image according to the period you set here. For example, the alarm snapshot period is from 6:00–18:00 Monday, device can snapshot during the 6:00–18:00 when an alarm occurs.

Step 1 Click Snapshot button, device goes to following interface. See Figure 4-28.

 **Note**

From main menu>Setting>Storage>Schedule>Snapshot, you can go to the snapshot interface.



Figure 4-24

Step 2 Select a channel to set schedule snapshot.

Step 3 Set snapshot type as schedule. Refer to chapter 4.2.5.3 Snapshot for detailed information.

Step 4 Check the box to set alarm type. See Figure 4-29.



Figure 4-25

 **Note**

- When the record type is MD (motion detect), alarm, MD&Alarm, IVS and POS, please enable the channel snapshot function when corresponding alarm occurs. For example, when the alarm type is MD, from main menu>Setting>Event>Video Detect>Motion Detect, please select the snapshot channel and enable snapshot function. See Figure 4-30.
- When the snapshot type is MD (motion detect), alarm, MD&Alarm, IVS, refer to chapter 4.7.1 Video detect, chapter 4.7.11 Alarm Settings, chapter 4.7.3 IVS and chapter 4.7.14 POS.

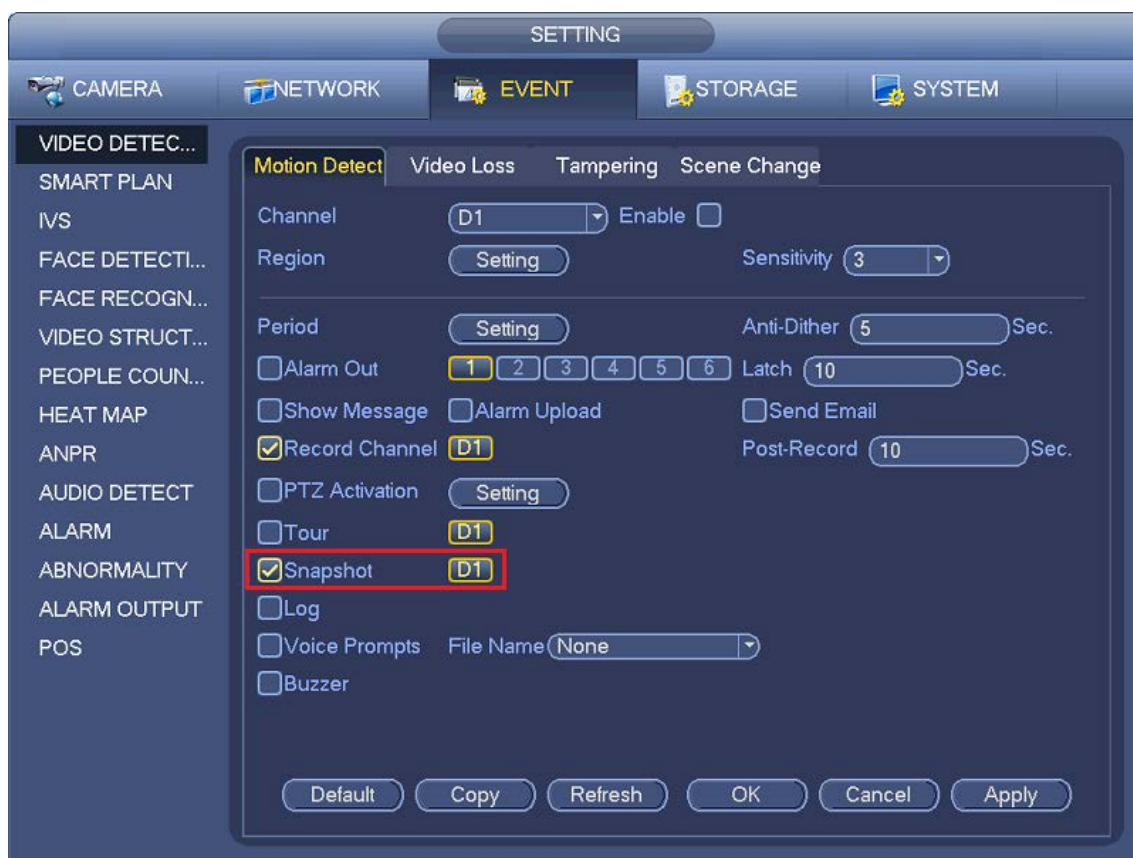

Figure 4-26

Step 5 Refer to chapter 4.1.4.5.1 to set snapshot period.

Step 6 Click Apply button to save snapshot plan.

 **Note**

Please enable auto snapshot function so that the snapshot plan can become activated. Refer to chapter 4.1.4.5.3 Record control for detailed information.

Step 7 Click Finish button, system pops up a dialogue box. Click the OK button, the startup wizard is complete. See Figure 4-31.



Figure 4-27

#### 4.1.4.5.3 Record Control

 **Note**

You need to have proper rights to implement the following operations. Please make sure the HDD has been properly installed.

There are three ways for you to go to record menu.

- Right click mouse and then select Manual>Record.
  - In the main menu, from Setting>Storage>Record.
  - In live viewing mode, click record button in the front panel or record button in the remote control.
- After set schedule record and schedule snapshot function, please enable auto record and auto snapshot function so that the device can automatically record and snapshot. System supports main stream and sub stream. There are three statuses: schedule/manual/stop. See Figure 4-32. Please highlight icon“o” to select corresponding channel.
- Manual: The highest priority. After manual setup, all selected channels will begin general recording.
  - Schedule: Channel records as you have set in recording setup (Main Menu>Setting>Storage>>Schedule)
  - Stop: Current channel stops recording.
  - All: Check All button after the corresponding status to enable/disable all-channel schedule/manual record or enable/disable all channels to stop record.
  - Snapshot: Select one or more channel(s) first and then enable/disable schedule snapshot function.



Figure 4-28

#### 4.1.4.5.4 Record Info

After system recorded video files, go to the record info interface to view device name, start time, end time and etc.

From main menu > Info-System > Record, the interface is shown as below. See Figure 4-33.

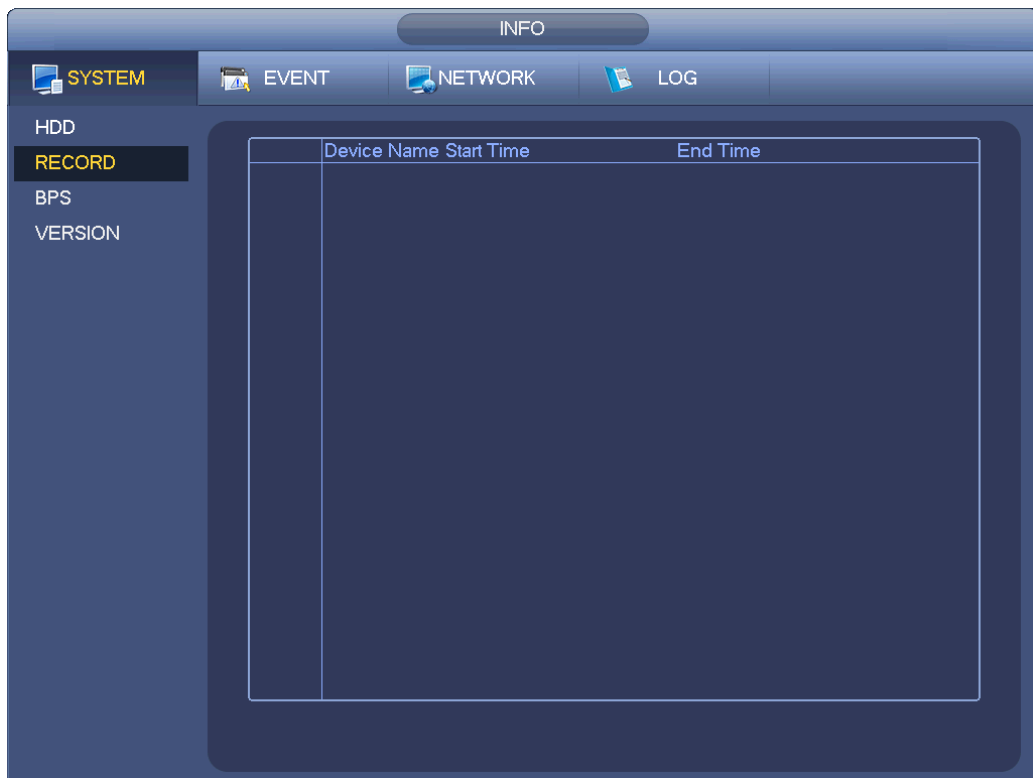

Figure 4-29

## 4.2 Camera

### 4.2.1 Connection

After register a remote device to the NVR, you can view the video on the NVR, and manage and storage the video file. Different series products support different remote device amount. Refer to chapter 4.1.4.4 Registration to add a camera.

#### 4.2.1.1 Change IP address

Step 1 From Main menu > Setting > Camera > Registration, check the box before the camera name

and then click Change IP or click the  before the camera name.

Enter change IP interface. See Figure 4-34.

#### Note

Check the box before several cameras, change the IP addresses of several cameras at the same time.

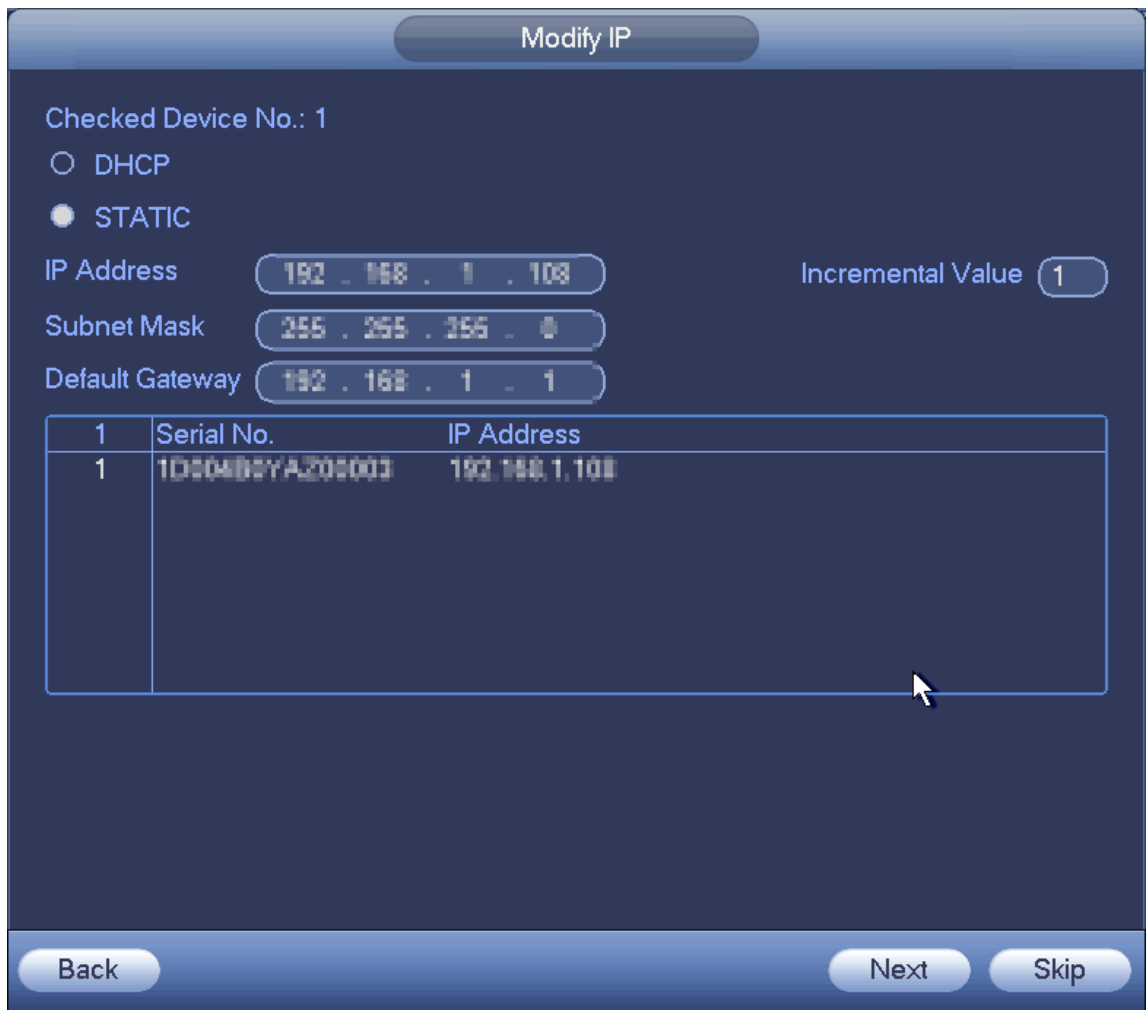

Figure 4-30

Step 2 Select IP mode.

Check DHCP, there is no need to input IP address, subnet mask, and default gateway. Device automatically allocates the IP address to the camera.

Check Static, and then input IP address, subnet mask, default gateway and incremental value.

 **Note**

If it is to change several devices IP addresses at the same time, please input incremental value. Device can add the fourth address of the IP address one by one to automatically allocate the IP addresses.

If there is IP conflict when changing static IP address, device pops up IP conflict dialogue box. If batch change IP address, device automatically skips the conflicted IP and begin the allocation according to the incremental value

Step 3 Input remote device user name and password.

Step 4 Click OK button to save settings.

After the changing operation, search again, device displays new IP address.

 **Note**

When change IP addresses of several devices at the same time, make sure the cameras user name and passwords are the same.

### 4.2.1.2 IP Export

Device can export the Added device list to your local USB device.

Step 1 Insert the USB device and then click the Export button.

Enter the following interface. See Figure 4-35.

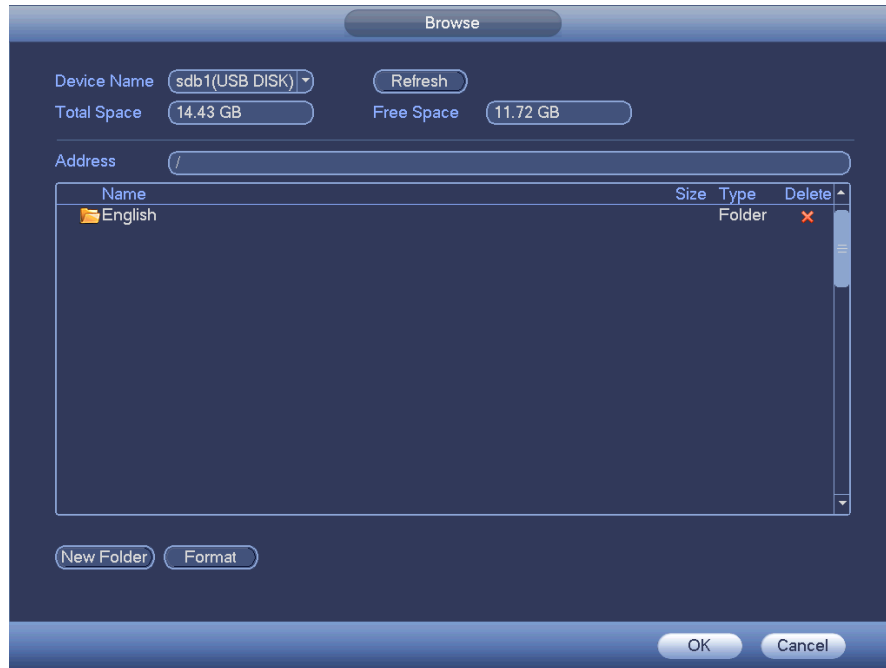

Figure 4-31

Step 2 Select the directory address and then click the OK button.

Step 3 Device pops up a dialogue box to remind you successfully exported. Please lick OK button to exit.

#### Note

The exported file extension name is .CVS. The file information includes IP address, port, remote channel number, manufacturer, user name and password.

### 4.2.1.3 IP Import

Step 1 Click Import button.

Enter the following interface. See Figure 4-36.

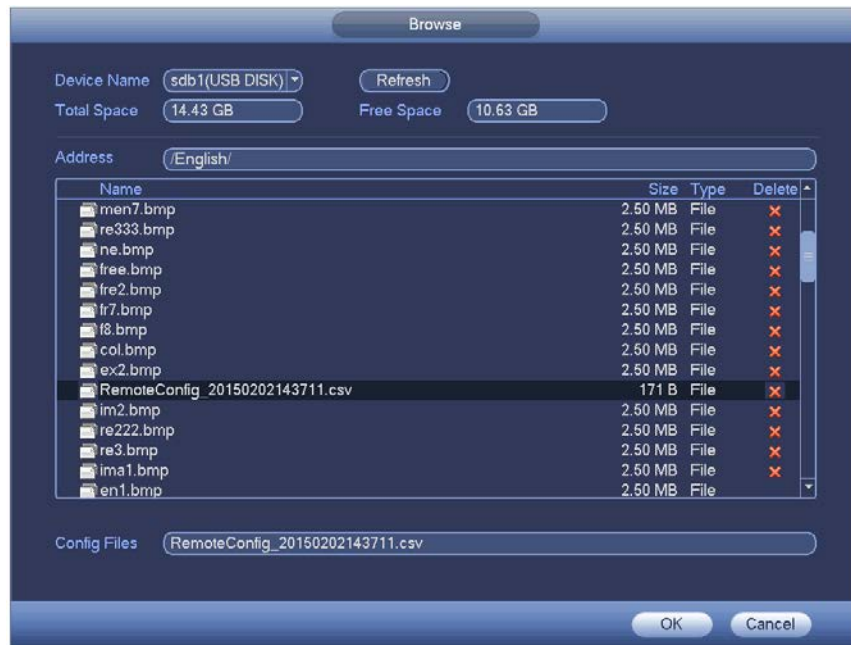

Figure 4-32

- Step 2 Select the import file and then click the OK button. System pops up a dialogue box to remind you successfully imported.
- Step 3 Click OK button to exit.

 **Note**

If the imported IP has conflicted with current added device, system pops up a dialogue box to remind you. You have two options:

- Step 4 Click OK button, system uses the imported setup to overlay current one.

 **CAUTION**

- You can edit the exported .CVS file. **Do not change the file format; otherwise it may result in import failure.**
- Does not support customized protocol import and export.
- The import and export device shall have the same language format.

## 4.2.2 Remote Device Initialization

Remote device initialization can change remote device login password and IP address.

 **Note**

- When connect a camera to the NVR via PoE port, NVR automatically initialize the camera. The camera adopts NVR current password and email information by default.
- When connect a camera to the NVR via PoE port after NVR upgraded to the new version, the NVR may fail to initialize the camera. Please go to the Registration interface to initialize the camera.

- Step 1 From main menu>Setting>Camera>Registration.  
Enter Registration interface.



- Step 2 Click Device Search and then click Uninitialized.  
Device displays camera(s) to be initialized.
- Step 3 Select a camera to be initialized and then click Initialize.  
Device displays password setup interface. See Figure 4-37.

 **Note**

- If you want to use current device password and email information, the remote device automatically uses NVR admin account information (login password and email). There is no need to set password and email. Please go to step 4.



Figure 4-33

1. Cancel using current device password and email information, Enter password setting interface. See Figure 4-38.

Enter Password

Using current device password and email info.

Username admin

Password

It is 8 to 32-digit containing letter(s), number(s), symbol(s). It contains at least two types.

Confirm Password

Next

Figure 4-34

2. Set camera password.

- The user name is **admin**. The password ranges from 8 to 32 digitals. It can contain letters, numbers and special characters (excluding “”, “'”, “;”, “:”, “&”). The password shall contain at least two categories. Usually we recommend the strong password.



### CAUTION

**STRONG PASSWORD RECOMMENDED**-For your device own safety, please create a strong password of your own choosing. We also recommend you change your password periodically especially in the high security system.

3. Click Next button.

Enter input email interface. See Figure 4-39.

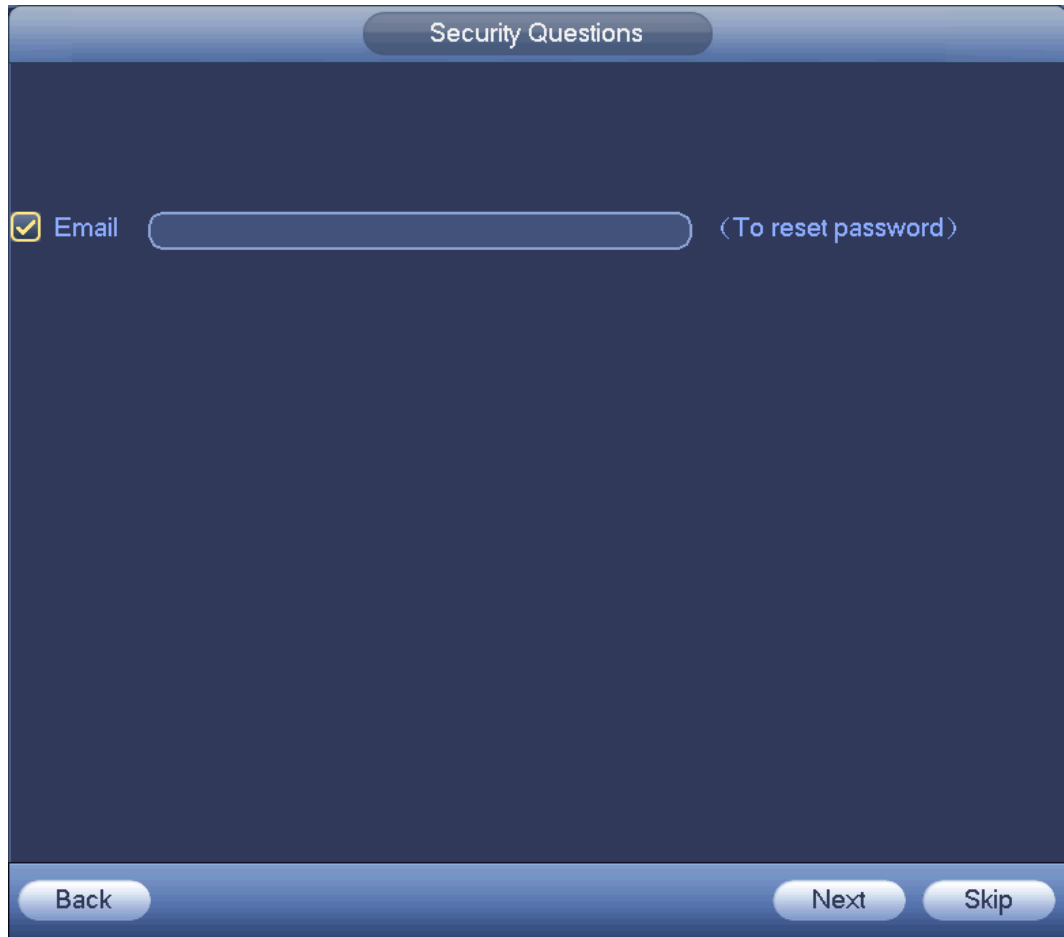

Figure 4-35

4. Set email information.

Email: Input an email address for reset password purpose.

 **Note**

Cancel the box and then click Next or Skip if you do not want to input email information here.

Step 4 Click Next button.

Enter Change IP address interface. See Figure 4-40.

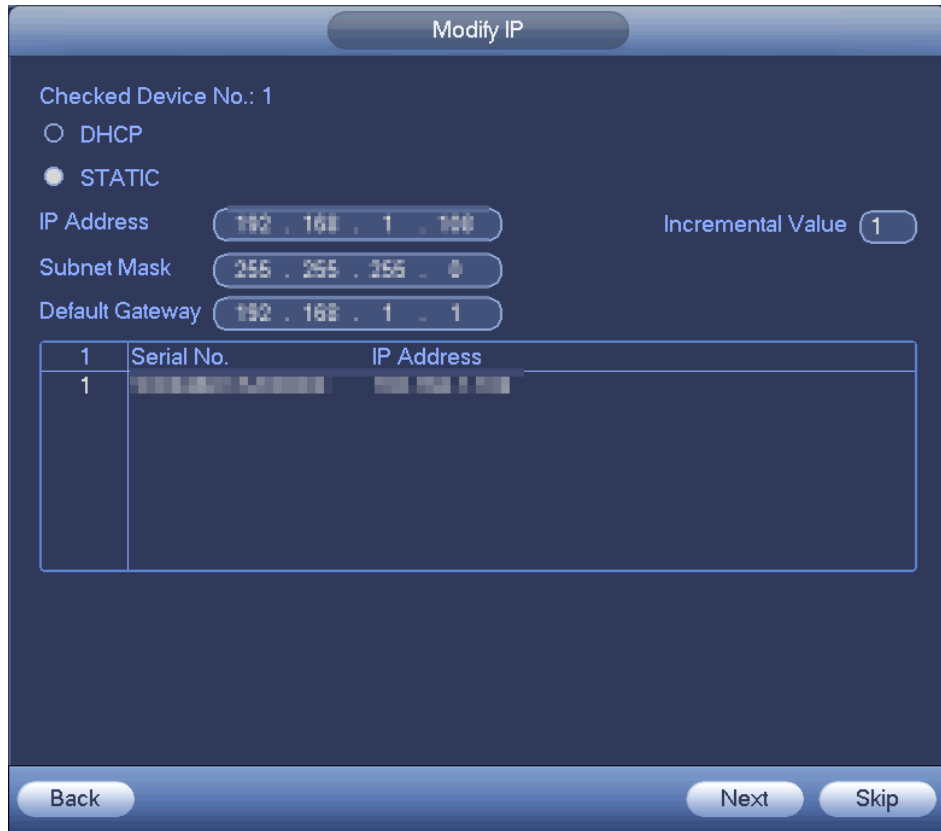

Figure 4-36

**Step 5** Set camera IP address

Check DHCP, there is no need to input IP address, subnet mask, and default gateway. Device automatically allocates the IP address to the camera.

Check Static, and then input IP address, subnet mask, default gateway and incremental value.

 **Note**

- If it is to change several devices IP addresses at the same time, please input incremental value. Device can add the fourth address of the IP address one by one to automatically allocate the IP addresses.
- If there is IP conflict when changing static IP address, device pops up IP conflict dialogue box. If batch change IP address, device automatically skips the conflicted IP and begin the allocation according to the incremental value

**Step 6** Click Next button.

Device begins initializing camera. See Figure 4-41.



## 4.2.4 Image

It is to set network camera parameters according to different environments. It is to get the best video effect.

From main menu>setting>camera>image, you can see the image interface is shown as below. See Figure 4-43.

- Channel: Select a channel from the dropdown list.
- Saturation: It is to adjust monitor window saturation. The value ranges from 0 to 100. The default value is 50. The larger the number, the stronger the color is. This value has no effect on the general brightness of the whole video. The video color may become too strong if the value is too high. For the grey part of the video, the distortion may occur if the white balance is not accurate. Please note the video may not be attractive if the value is too low. The recommended value ranges from 40 to 60.
- Brightness: It is to adjust monitor window bright. The value ranges from 0 to 100. The default value is 50. The larger the number is, the brighter the video is. When you input the value here, the bright section and the dark section of the video will be adjusted accordingly. You can use this function when the whole video is too dark or too bright. Please note the video may become hazy if the value is too high. The recommended value ranges from 40 to 60.
- Contrast: It is to adjust monitor window contrast. The value ranges from 0 to 100. The default value is 50. The larger the number is, the higher the contrast is. You can use this function when the whole video bright is OK but the contrast is not proper. Please note the video may become hazy if the value is too low. If this value is too high, the dark section may lack brightness while the bright section may over exposure. The recommended value ranges from 40 to 60.
- Auto Iris: It is for the device of the auto lens. You can check the box before ON to enable this function. The auto iris may change if the light becomes different. When you disable this function, the iris is at the max. System does not add the auto iris function in the exposure control. This function is on by default.
- Mirror: It is to switch video up and bottom limit. This function is disabled by default.
- Flip: It is to switch video left and right limit. This function is disabled by default.
- BLC: It includes several options: BLC/WDR/HLC/OFF.
- ◇ BLC: The device auto exposures according to the environments situation so that the darkest area of the video is cleared
- ◇ WDR: For the WDR scene, this function can lower the high bright section and enhance the brightness of the low bright section. So that you can view these two sections clearly at the same time. The value ranges from 1 to 100. When you switch the camera from no-WDR mode to the WDR mode, system may lose several seconds record video.
- ◇ HLC: After you enabled HLC function, the device can lower the brightness of the brightest section according to the HLC control level. It can reduce the area of the halo and lower the brightness of the whole video.
- ◇ OFF: It is to disable the BLC function. Please note this function is disabled by default.
- Profile: It is to set the white balance mode. It has effect on the general hue of the video. This function is on by default. You can select the different scene mode such as auto, sunny, cloudy, home, office, night, disable and etc to adjust the video to the best quality.
- ◇ Auto: The auto white balance is on. System can auto compensate the color temperature to make sure the video color is proper.
- ◇ Sunny: The threshold of the white balance is in the sunny mode.
- ◇ Night: The threshold of the white balance is in the night mode.

- ✧ Customized: You can set the gain of the red/blue channel. The value ranges from 0 to 100.
- Day/night. It is to set device color and the B/W mode switch. The default setup is auto.
- ✧ Color: Device outputs the color video.
- ✧ Auto: Device auto select to output the color or the B/W video according to the device feature (The general bright of the video or there is IR light or not.)
- ✧ B/W: The device outputs the black and white video.
- ✧ Sensor: It is to set when there is peripheral connected IR light.

Please note some non-IR series product support sensor input function.

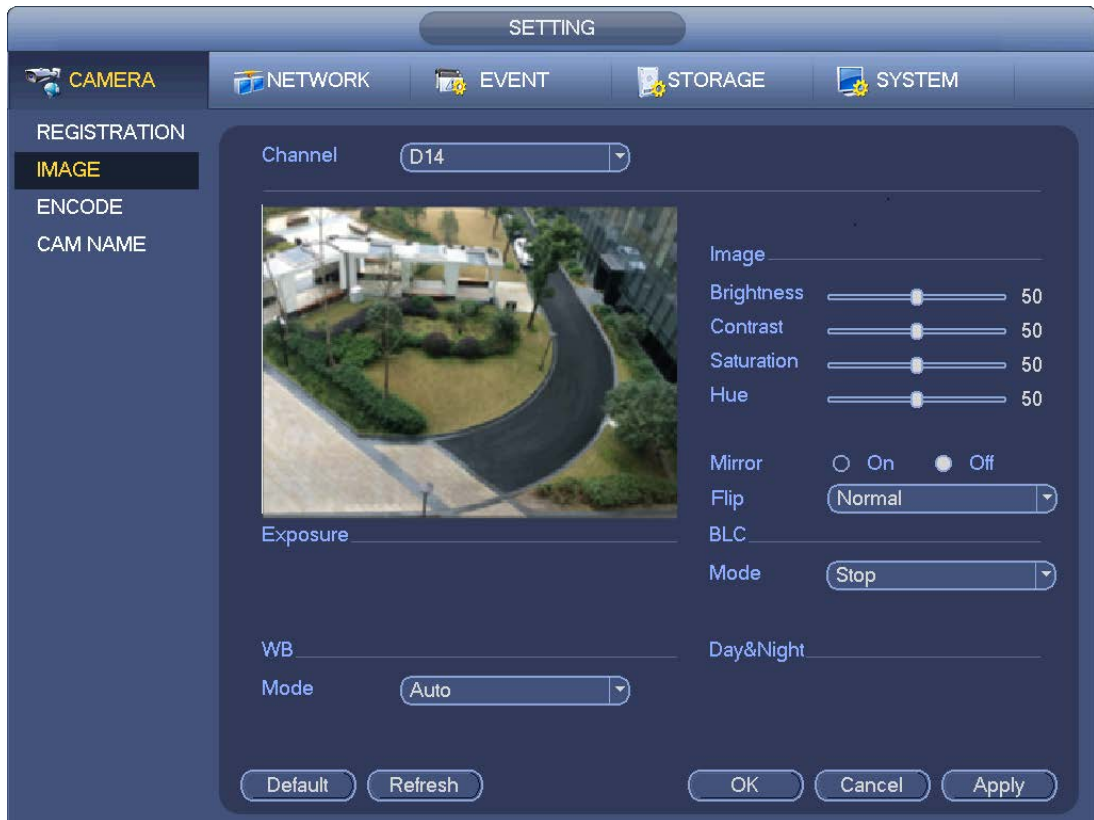

Figure 4-39

## 4.2.5 Encode

It is to set video encode parameters such as video bit rates, video overlay, snapshot settings.

### 4.2.5.1 Encode

It is to set IPC encode mode, resolution, bit stream type and etc.

#### Note

Some series products support three streams: main stream, sub stream 1, sub stream 2. The sub stream maximally supports 1080P.

From Main menu>Setting>System>Encode, you can see the following interface. See Figure 4-44.

- Channel: Select the channel you want.
- Type: It is to set device bit stream type.
- ✧ For main stream, there are three options: regular/motion detect/alarm. The sub stream supports regular bit streams only.

- ✧ The active control frame function (ACF) can record in different frame rates. For example, you can use high frame rate to record important events, record scheduled event in lower frame rate.
- ✧ Set different frame rates for different record events.

 **Note**

Some series products do not support motion detect bit streams and alarm streams.

- Compression: Video encode mode.
  - ✧ H.264: Main Profile encode mode.
  - ✧ H.264H: High Profile encode mode.
  - ✧ H.264B: Baseline Profile encode mode.
  - ✧ H.265: Main Profile encode mode.
  - ✧ MJPEG: System needs high bit streams to guarantee video definition. Use the recommended max bit stream value to get the better video effect.
- Smart Codec: This function is to reduce bit streams.

 **Note**

- ✧ Some series products support smart codec function.
- ✧ After changing smart code, please reboot network camera and some network camera functions (such as IVS, ROI, SVC, lobby mode and etc.) becomes null. Please think twice before the operation.

- Resolution: The resolution here refers to the capability of the network camera.

 **Note**

Different series products support different resolutions. Please refer to the actual interface for detailed information.

- Frame rate (FPS): The video frame amount displayed in each second. The higher the frame rate is, the clearer and more fluent the video is. The frame rate may vary depending on the resolution.
- Bit rate type: System supports two types: CBR and VBR.
  - ✧ Main stream: It is to set frame rate to change video quality. The higher the frame rate is, the better the video quality is. The referenced bit rate is the recommended value.
  - ✧ Sub stream: In CBR mode, the bit stream is near the specified value. In VBR mode, the video quality changes according to the bit stream value. But its max value is near the specified value.

Reference bit rate: The reference bit rate depends on the resolution and frame rate you set.
- Video/audio: You can enable or disable the video/audio. The main stream is enabled by default. After enable the audio function, the record file is composite file consisting of the video and audio. For the sub stream 1, please enable video first and then enable audio function.
- Audio format: Set audio encode format.

 **Note**

Different series products support different audio encode mode. Please refer to the actual interface for detailed information.

- Sampling rate: Audio sampling rate refers to the sampling amount within 1 second. The higher the value is, the better the audio is. The default setup is 8K.
- Copy: After you complete the setup, you can click Copy button to copy current setup to other channel(s). You can see an interface is shown as in Figure 4-47. You can see current channel number is grey. Please check the number to select the channel or you can check the box ALL.



Please click the OK button in Figure 4-47 and Figure 4-45 respectively to complete the setup. Please note, once you check the All box, you set same encode setup for all channels. Audio/video enable box, overlay button and the copy button is shield.

Please highlight icon  to select the corresponding function.



Figure 4-40

### 4.2.5.2 Overlay

Click overlay button, you can see an interface is shown in Figure 4-45.

- Cover area: Here is for you to cover area section. You can drag you mouse to set proper section size. In one channel video, system max supports 4 zones in one channel. You can set with Fn button or direction buttons.
- Preview/monitor: The cover area has two types. Preview and Monitor. Preview means the privacy mask zone cannot be viewed by user when system is in preview status. Monitor means the privacy mask zone cannot be view by the user when system is in monitor status.
- Time display: You can select system displays time or not when you playback. Please click set button and then drag the title to the corresponding position in the screen.
- Channel display: You can select system displays channel number or not when you playback. Please click set button and then drag the title to the corresponding position in the screen.



Figure 4-41

### 4.2.5.3 Snapshot

Here you can set snapshot mode, picture size, quality and frequency. See Figure 4-46.

- Snapshot mode: There are two modes: regular and trigger. If you set regular mode, you need to set snapshot frequency. If you set trigger snapshot, you need to set snapshot activation operation.
- Image size: Here you can set snapshot picture size.
- Image quality: Here you can set snapshot quality. The value ranges from 1 to 6.
- Interval: It is for you to set timing (schedule) snapshot interval.



Figure 4-42

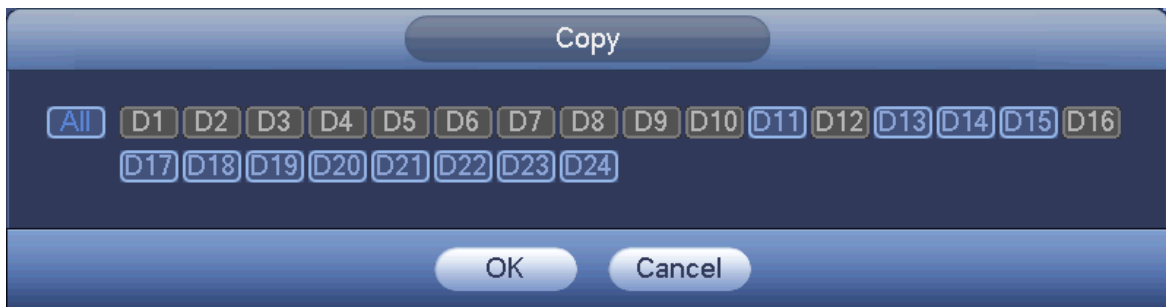

Figure 4-43

## 4.2.6 Channel Name

From main menu>Setting>Camera-Channel name, you can see an interface shown as in Figure 4-48. It is to modify channel name. It max supports 63-character.

Please note you can only modify the channel name of the connected network camera.



Figure 4-44

## 4.2.7 Remote Upgrade

It is to upgrade the connected network camera firmware. It includes online upgrade and file upgrade. From main menu>setting>camera>remote, the interface is shown as below. See Figure 4-49.



Figure 4-45

## Online Upgrade

- Step 1 Select a remote device and then click the Detect button on the right side, or check a box to select a remote device and then click Manual Check.  
System detects the new version on the cloud.
- Step 2 Select a remote device that has new version and then click online upgrade.  
After successful operation, system pops up upgrade successful dialogue box.

## File upgrade

- Step 1 Select a channel and then click File upgrade.
- Step 2 Select upgrade file on the pop-up interface.
- Step 3 Select the upgrade file and then click OK button.  
After successful operation, system pops up upgrade successful dialogue box.

### Note

If there are too much remote devices, select device type from the drop-down list to search the remote device you desire.

## 4.2.8 Remote Device Info

### 4.2.8.1 Device Status

Here you can view the IPC status of the corresponding channel such as motion detect, video loss, tampering, alarm and etc. See Figure 4-50.



- IPC status: : Front-end does not support. : Front-end supports. : There is alarm event from current front-end.
- Connection status: : Connection succeeded. : Connection failed.
- Refresh: Click it to get latest front-end channel status.



Figure 4-46

#### 4.2.8.2 Firmware

It is to view channel, IP address, manufacturer, type, system version, SN, video input, audio input, external alarm and etc. See Figure 4-51.



Figure 4-47

## 4.3 Preview

After device booted up, the system is in multiple-channel display mode. See Figure 4-52. Please note the displayed window amount may vary. The following figure is for reference only. Specifications for the window-amount your product supported.

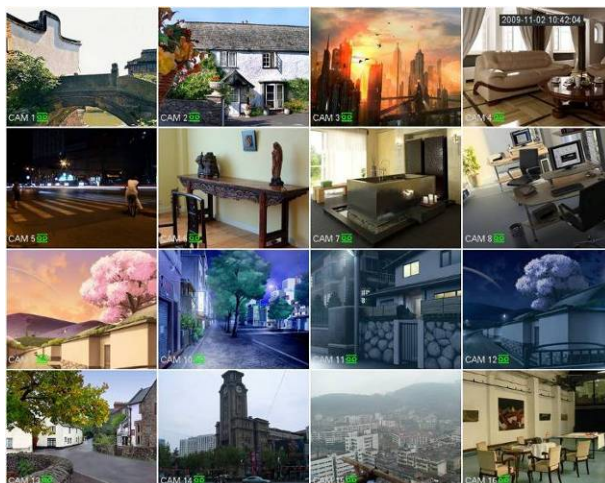

Figure 4-48

### 4.3.1 Preview

If you want to change system date and time, you can refer to general settings (Main Menu>Setting>System>General). If you want to modify the channel name, please refer to the display settings (Main Menu>Camera>CAM name)

Please refer to the following sheet for detailed information.

SN	Icon	Function
1		When current channel is recording, system displays this icon.
2		When motion detection alarm occurs, system displays this icon.
3		When video loss alarm occurs, system displays this icon.
4		When current channel is in monitor lock status, system displays this icon.

#### Tips

- Preview drag: If you want to change position of channel 1 and channel 2 when you are previewing, you can left click mouse in the channel 1 and then drag to channel 2, release mouse you can switch channel 1 and channel 2 positions.
- Use mouse middle button to control window split: You can use mouse middle button to switch window split amount.

## 4.3.2 Navigation bar

On the preview interface, left click mouse, you can view the navigation bar. See Figure 4-53 or Figure 4-54.



### Note

- Different series products may display different navigation bar icons. Refer to the actual product for detailed information.
- Go to the Main menu>Setting>System>General to enable navigation bar function; otherwise you cannot see the following interface.



Figure 4-49



Figure 4-50

### 4.3.2.1 Main Menu



Click button  to go to the main menu interface.

### 4.3.2.2 Dual-screen operation

#### Important

This function is for some series only.



Click  to select screen 2, you can view an interface shown as below. See Figure 4-55. It is a navigation bar for screen 2.



Figure 4-51

Click any screen split mode; HDMI2 screen can display corresponding screens. Now you can control two screens. See Figure 4-56.



Figure 4-52







#### Note

- Screen 2 function is null if tour is in process. Please disable tour function first,
- Right now, the screen 2 operation can only be realized on the navigation bard. The operations on the right-click menu are for screen 1 only.



### 4.3.2.3 Output Screen

Click  to select corresponding window-split mode and output channels.

### 4.3.2.4 Previous screen/next screen

Click  to go back to the previous screen, click  to go to the next screen.

### 4.3.2.5 Tour

Click button  to enable tour, the icon becomes , you can see the tour is in process.



#### Note

Close the tour or the triggered tour operation has cancelled, device restore the previous preview video.

### 4.3.2.6 PTZ

Click , system goes to the PTZ control interface. Please refer to chapter 4.4.2 PTZ for detailed information.

### 4.3.2.7 Color

Click button , system goes to the color interface.  
Please make sure system is in one-channel mode.



### 4.3.2.8 Image

Click  to go to the image interface. Please refer to chapter 4.2.4 Image for detailed information.  
Please make sure system is in one-channel mode.

### 4.3.2.9 Search

Click button , system goes to search interface. Please refer to chapter 4.6.2 Search for detailed information.

### 4.3.2.10 Broadcast

Click  to go to broadcast interface. Select a group name and then click  to begin broadcast. Please refer to chapter 4.10.5 Broadcast for detailed information.

### 4.3.2.11 Alarm Status

Click button , system goes to alarm status interface. It is to view device status and channel status. Please refer to chapter 4.10.2.3.1 Alarm status for detailed information.

### 4.3.2.12 Channel Info

Click button , system goes to the channel information setup interface. It is to view information of the corresponding channel. See Figure 4-57.









Channel	Motion Detect	Video Loss	Tampering	Record Status	Bit Rate(Kb/S)	Status	Record Mode
2	--	--	--		3934		Continuous
4	--	--	--		4245		Continuous
6	--	--	--		6159		Continuous

Figure 4-53

### 4.3.2.13 Registration



Click , system goes to the registration interface. Please refer to chapter 4.1.4.5.3 Registration for detailed information.

### 4.3.2.14 Network



Click , system goes to the network interface. It is to set network IP address, default gateway and etc. Please refer to chapter 4.8 Network for detailed information.

### 4.3.2.15 HDD Manager



Click , system goes to the HDD manager interface. It is to view and manage HDD information. Please refer to chapter 4.9.1 HDD manager for detailed information.

### 4.3.2.16 USB Manager



Click , system goes to the USB Manager interface. It is to view USB information, backup and update. Please refer to chapter 4.10.8.1 File backup, chapter 4.10.8.3 Backup log, chapter 4.10.8.2 Import/export, and chapter 4.10.10 Upgrade for detailed information.

## 4.3.3 Preview Control Interface

Move your mouse to the top center of the video of current channel, you can see system pops up the preview control interface. See Figure 4-58. If your mouse stays in this area for more than 6 seconds and has no operation, the control bar automatically hides.



Figure 4-54



1) Instant playback

It is to playback the previous 5-60 minutes record of current channel.

Please go to the Main menu>Setting>System>General to set real-time playback time. System may pop up a dialogue box if there is no such record in current channel.

2) Digital zoom

It is to zoom in specified zone of current channel. It supports zoom in function of multiple-channel.

Click button , the button is shown as .

There are two ways for you to zoom in.

- Drag the mouse to select a zone, you can view an interface show as Figure 4-59.



Figure 4-55

- Put the middle button at the center of the zone you want to zoom in, and move the mouse, you can view an interface shown as in Figure 4-60.

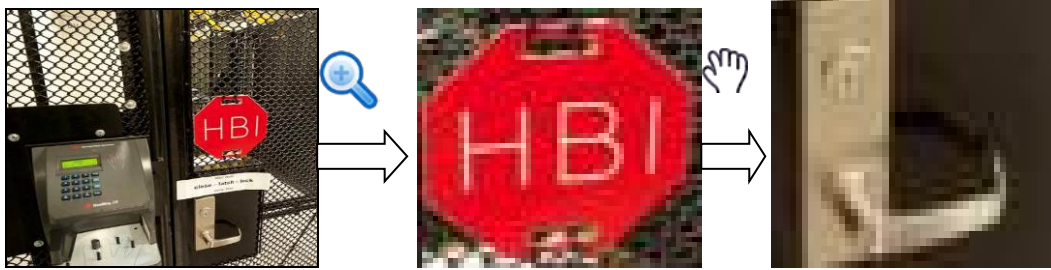



Figure 4-56

Right click mouse to cancel zoom and go back to the original interface.

### 3) Manual record function



It is to back up the video of current channel to the USB device. System cannot backup the video of multiple-channel at the same time.



Click button , system begins recording. Click it again, system stops recording. You can find the record file on the flash disk.

### 4) Manual Snapshot

Click  to snapshot 1-5 times. The snapshot file is saved on the USB device or HDD. You can go to the Search interface (chapter 4.5) to view.

### 5) Bidirectional talk

If the connected front-end device supports bidirectional talk function, you can click this button. Click button  to start bidirectional talk function the icon now is shown as . Now the rest bidirectional talk buttons of digital channel becomes null too.

Click  again, you can cancel bidirectional talk and the bidirectional talk buttons of other digital channels become as .

### 6) Switch bit streams

Click  to switch the bit stream type of the main stream and sub stream.

- M: Main stream. Its bit streams are big and definition is high. It occupies large network bandwidth suitable for video wall surveillance, storage and etc.
- S: Sub stream. Its definition is low but occupies small network bandwidth. It is suitable for general surveillance, remote connection and etc. Some series products support two sub streams (S1, S2). Refer to chapter 4.2.5.1 Encode for detailed information.

## 4.3.4 Right-Click Menu

By right-clicking the menu, you can quickly access the corresponding functional interface and perform relevant operations, including entering the main menu, searching records and selecting screen split mode.

Right-click on the preview interface and the right-click menu is displayed. See Figure 4-61.

 NOTE

The right-click menu is different for different models. The actual interface shall prevail.

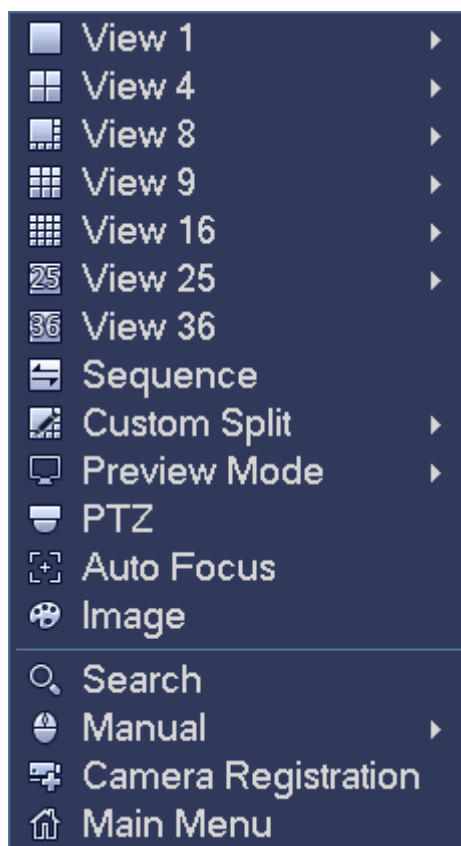

Figure 4-57

You can do the following operations through the right-click menu:

- Screen split: You can select the split mode and channel number.
- Sequence: Adjust the sequence of the channels displayed on the preview interface. For details, see "4.3.6 Sequence"
- Customize screen: Select the customized screen split mode.
- Preview mode: Regular mode and AI mode are available.  
When you select AI mode, system displays the detected face images, human body images and car plate images on the right side of the preview interface. For details, see "4.3.5 AI Preview Mode."
- PTZ control: Click PTZ to enter the setting interface. For details, see "4.4 PTZ."
- Auto focus: Set auto focus. The front-end device shall support this function.
- Camera: Set the camera image property. For details, see "4.2.4 Image"
- Search: Search and play back record files. For details, see "4.6 Playback and Search."
- Manual: Manual control record mode and alarm mode.
- Camera registration: Search and register remote device.
- Main menu: Enter the main menu interface.

 NOTE

After entering the corresponding interface, right click the mouse on the interface to return to the upper level interface.

### 4.3.5 AI Preview Mode

When you select AI mode, the system displays information of human face, personnel, vehicle and non-motor vehicle on the right side of the preview interface, and it supports to play back records and display feature attributes.

 NOTE

You shall enable face detection, personnel detection, vehicle detection and non-motor vehicle detection to support this function. For details, see "4.7.6 Video Structurization."

Step 1 Right click to select Preview Mode > AI Mode.

The AI preview interface is displayed. See Figure 4-62.

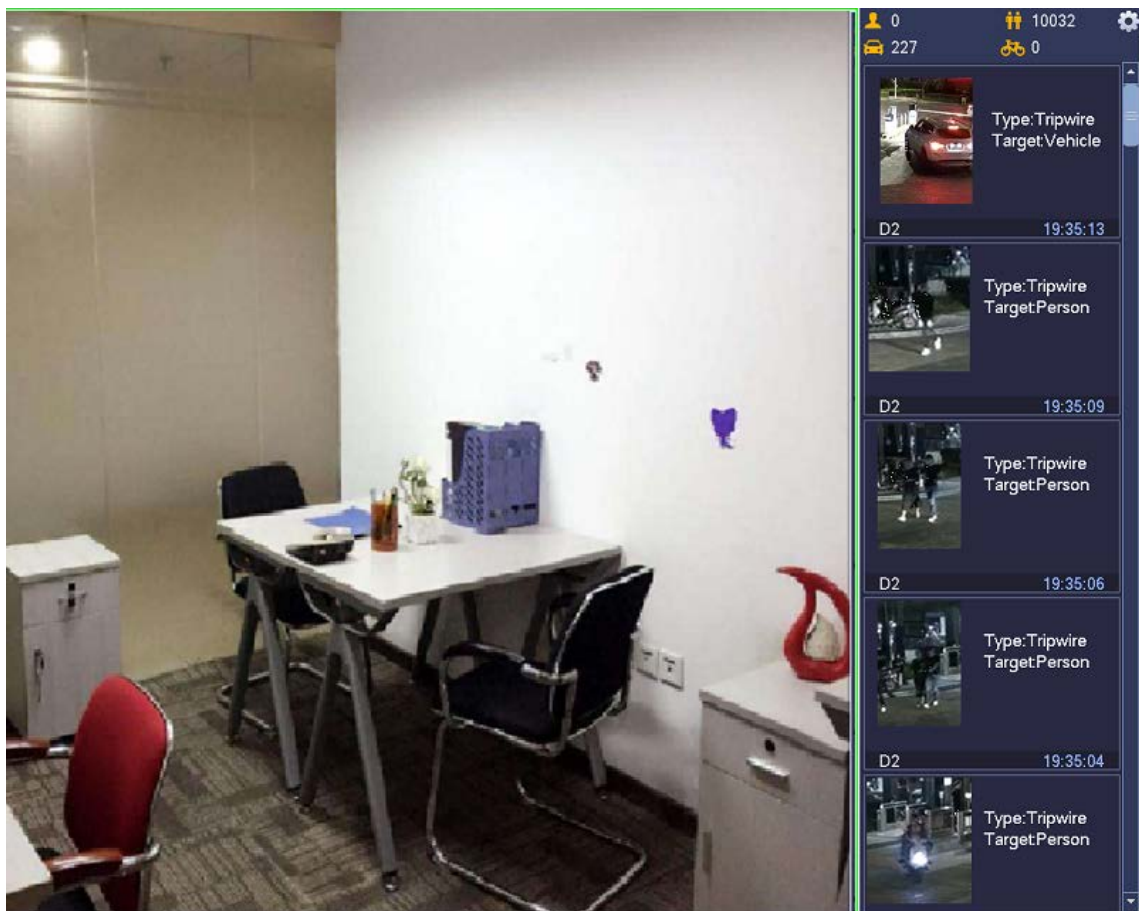

Figure 4-58

Step 2 (Optional) Double-click the image on the right to play the corresponding video.

Step 3 Click .

The Properties interface is displayed. See Figure 4-63.



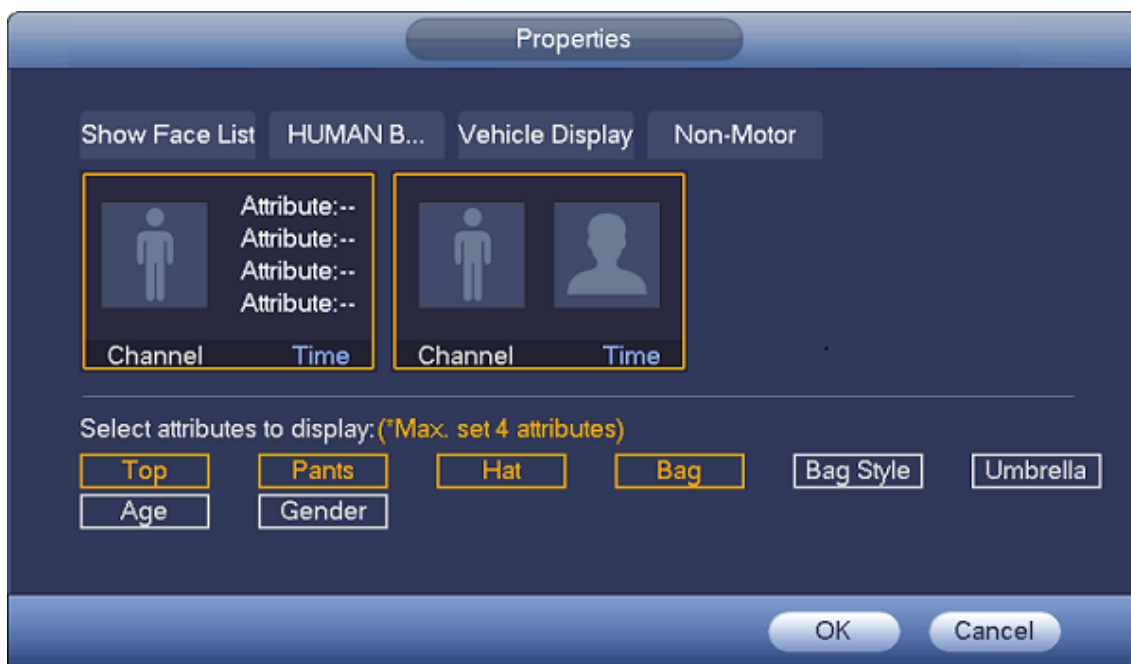

Figure 4-59

- Step 4 (Optional) Click Show Face List and select attributes to display, including age, gender, expression, glasses, beard and mask.
- Step 5 (Optional) Click Human Body Detection and select attributes to display, including top, pants, hat, bag, bag style, umbrella, age and gender. See Figure 4-64.

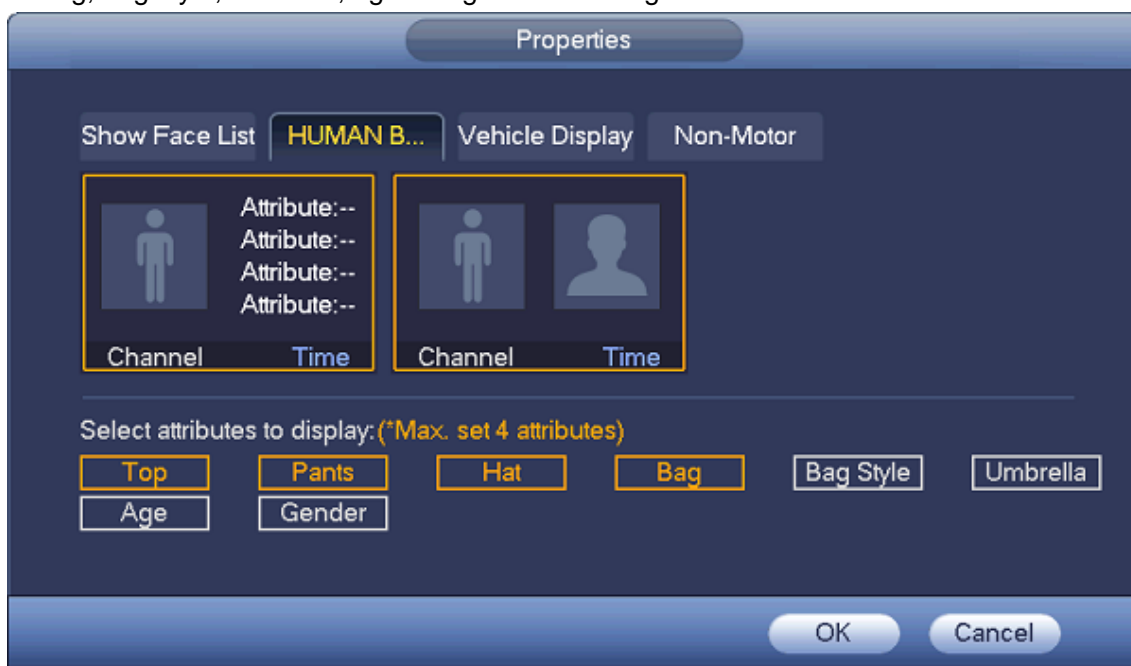

Figure 4-60

- Step 6 (Optional) Click Vehicle Display and select attributes to display, including vehicle logo, vehicle color, vehicle model, plate recognition, plate color, seatbelt, call, vehicle decorations and countries & regions. See Figure 4-65.





Figure 4-61

Step 7 (Optional) Click Non-Motor and select attributes to display, including color, type and people number. See Figure 4-66

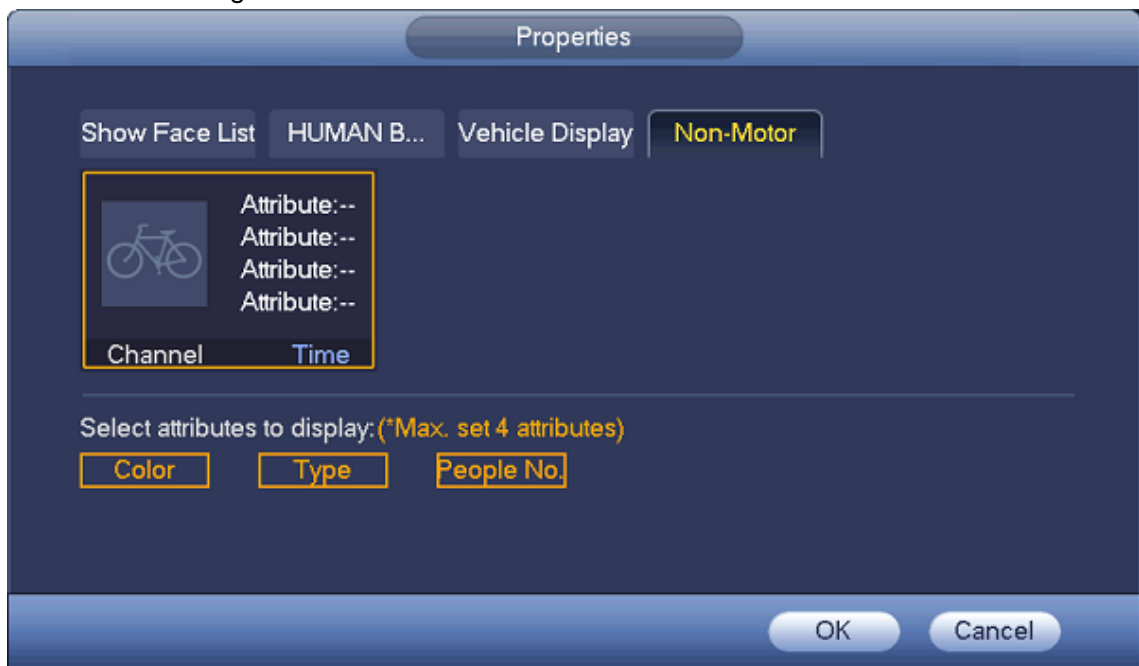

Figure 4-62

Step 8 Click OK to complete the setting.

 NOTE

The system can display four attributes at most.

### 4.3.6 Sequence

It is to set customized view layout.







## CAUTION

The preview layout restores default channel layout after Default operation. (Main menu>Setting>General>Default).

Step 1 On the preview interface, right click mouse and then click Edit view. Enter edit view interface. See Figure 4-67.



### Note

- Enter edit view interface, device automatically switches to the max split amount mode.
- The channel list on the edit view interface displays the added camera channel number and channel name.  means camera is online.  means camera is offline.
- In case the channel amount has exceeded the device max split amount, the edit view interface can display the max screen number amount and current screen number. In Figure 4-67, click  or , switch the video from other channel.

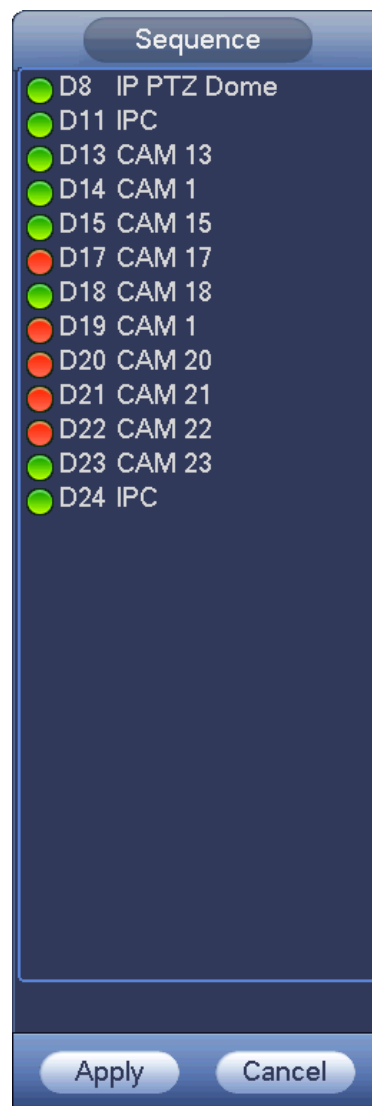

Figure 4-63

Step 2 On the edit view interface, drag the channel to the desired window, or drag on the preview window to switch the position.

Check the channel number at the right bottom corner to view the current channel sequence. See Figure 4-68.



Figure 4-64

Step 3 Click Apply to save current channel sequence.

After you change the channel sequence, click Cancel button or right click mouse, device pops up the dialog box. See Figure 4-69.

- Click OK to save current settings.
- Click Cancel to exit without saving the settings.

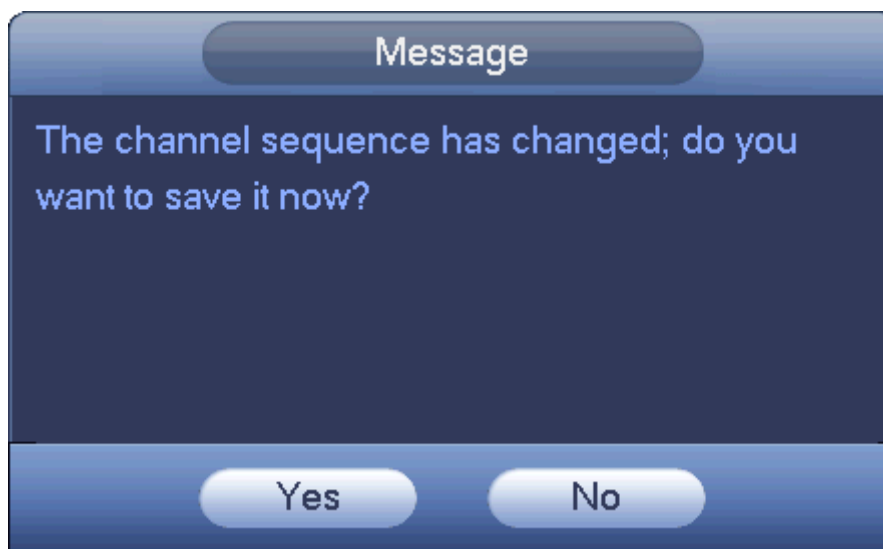

Figure 4-65

## 4.3.7 Preview Display Effect Settings

### 4.3.7.1 Display

Set the display effect of the device preview interface, including image output display mode, OSD display, etc.

Step 1 Enter from main menu > Setting > System > Display > Display.



The Display interface is displayed. See Figure 4-70.



Figure 4-66

Step 2 Configure the parameters. For details, see the following table.

Parameter	Description
Transparency	Set the transparency of the local menu of the NVR device. The higher the transparency, the more transparent the local menu.
Time Display/Channel Display	Select the check box and the date and time of the system will be displayed in the preview screen.
Image Enhance	Select the check box to optimize the preview image edges.
IVS Rule	Select the check box to display the IVS rules in the preview interface.  <div style="border: 1px solid gray; padding: 5px;"> <b>Note</b>                      Only some devices support this function. See the actual situation.                 </div>
Original Scale	Click Setting and select the channel to restore the corresponding channel image to the original scale.

Parameter	Description
Main Screen	Select VGA+HDMI1 or HDMI2.  <b>Note</b> Different devices display different contents. See the actual situation.
Screen Enable	Select the check box to enable this screen. The image can only be displayed when the screen is enabled.
Screen No.	Select the screen number you want to set the resolution.
Resolution	Support 1920×1080, 1280×1024, 1280×720, 1024×768, 3840×2160. The default resolution is 1280×1024. 1. Change the resolution and click Apply or OK. The system prompts to confirm the change and starts the 10s countdown. 2. Click OK. The system switches to the new resolution. Click Cancel or wait until the countdown ends and system restores the original resolution.  <b>Note</b> Only some devices support 3840×2160. See the actual situation.
Screen No.	Enter the screen number you want to set the audio input.
Channel	Select the channel number.
Audio Input	Select from audio 1, audio 2 and mix output.

Step 3 Click OK to complete the display setting.

### 4.3.7.2 TV adjust

 **Note**

Some series product supports TV adjust function. This function is disabled by default.

From Main Menu > Setting > System > Display > TV adjust; you can go to the following interface. See Figure 4-71. Here you can set margins and brightness.

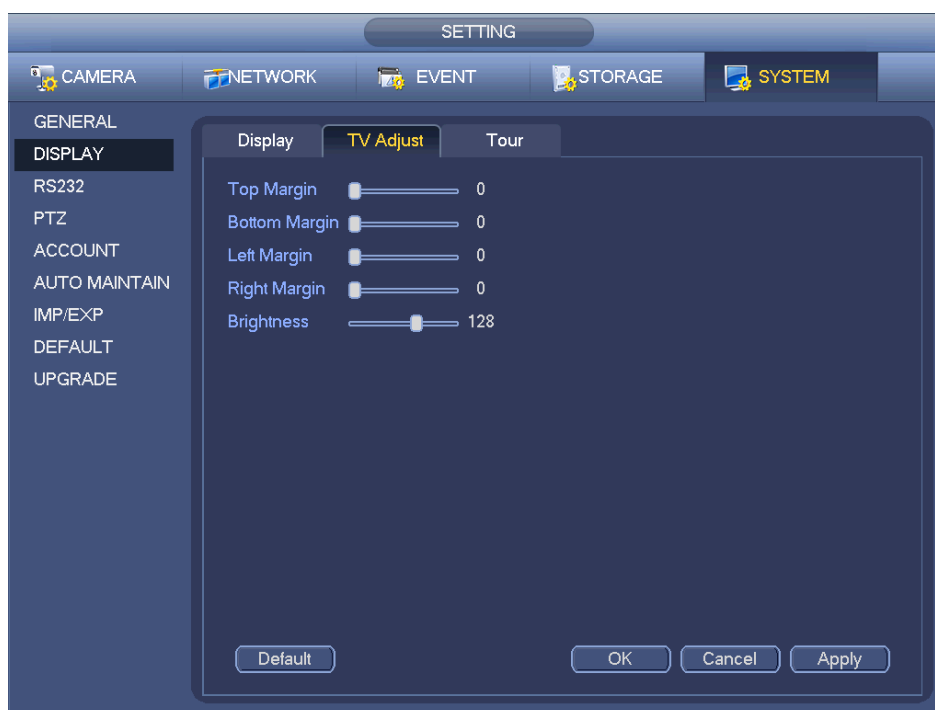

Figure 4-67

### 4.3.7.3 Preview Tour Parameters

Set preview display mode, channel display sequence and tour setup.

- Set preview display mode: On the preview interface, right click mouse, you can view right-click menu. Now you can select preview window amount and channel.
- Set channel display mode: On the preview interface, if you want to change channel 1 and channel 16 position, please right click channel 1 video window and then drag to the channel 16 video window, release button, you can change channel 1 and channel 16 position.
- Tour setup: Here you can set preview window channel display mode and interval. Please follow the steps listed below.

From Main menu>Setting>System>Display>Tour, you can see an interface shown as in Figure 4-72.

Here you can set tour parameter.

- Enable tour: Check the box here to enable tour function. The general tour supports all types of window split mode.
- Interval: Input proper interval value here. The value ranges from 1-120 seconds.
- Motion tour type: System support 1/8-window tour. Please note you need to go to the main menu>Setting>Event>Video detect>Motion detect to enable tour function.
- Alarm tour type: System support 1/8-window tour. Please note you need to go to the main menu>Setting>Event>Alarm to enable tour function.
- Window split: It is to set window split mode.



Figure 4-68

**Note**

On the navigation bar, click / to enable/disable tour.  
Click Save button to save current setup.

### 4.3.7.4 Customized split

It is to set customized video split mode.

**Note**

- This function is for some series products. Please refer to the actual product for detailed information.
- Device max supports 5 customized videos.

From Main menu>Setting>System>Display>Custom split, you can see an interface shown as in Figure 4-73.

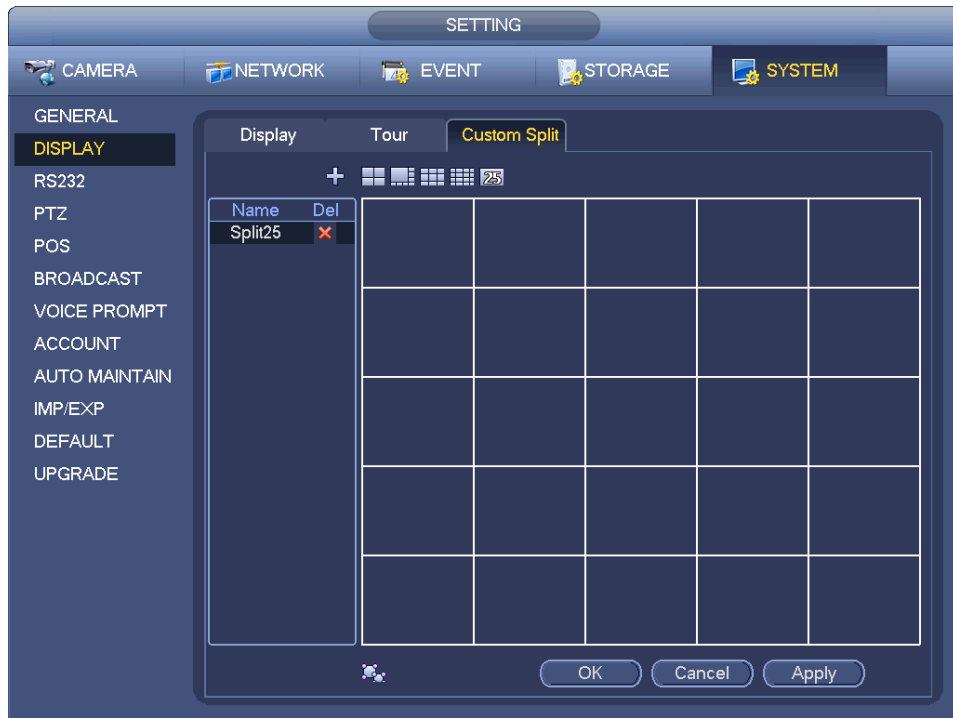

Figure 4-69

Click and then click to select basic mode

In regular mode, drag the mouse in the preview frame; you can merge several small windows to one window so that you can get you desired split mode.

After the setup, the selected window has the red frame. See Figure 4-74.

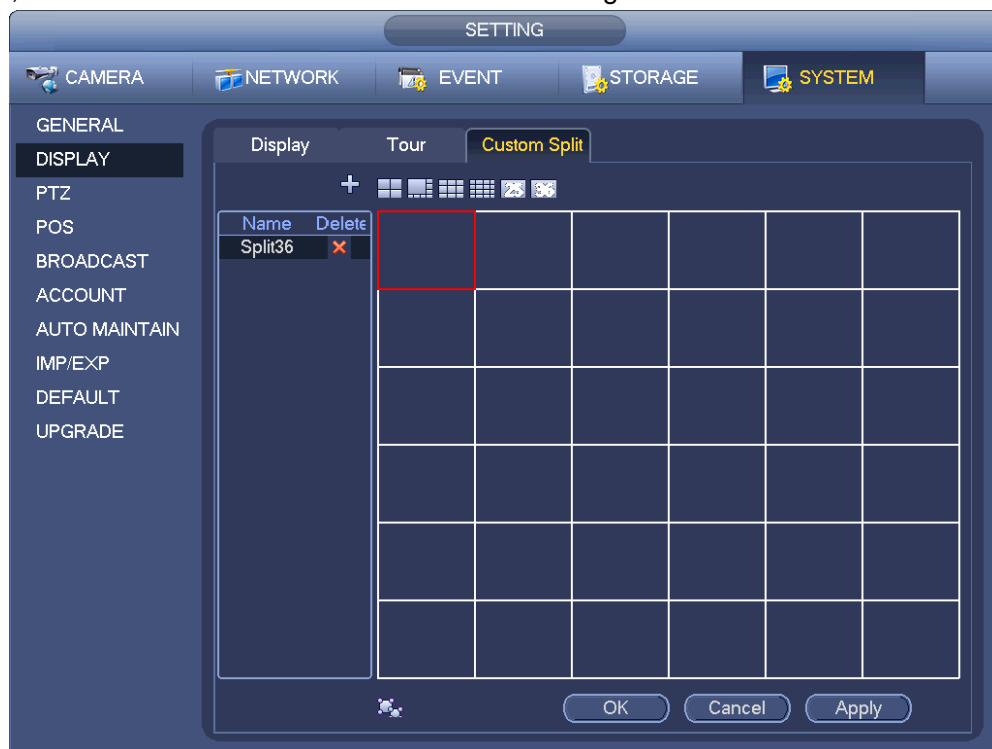



Figure 4-70



Select the merging window, the frame is red; you can click  to cancel the merge to restore regular mode.

Click Save to exit.

After the setup, you can go to the preview window, right click mouse and then select custom split. See Figure 4-75.

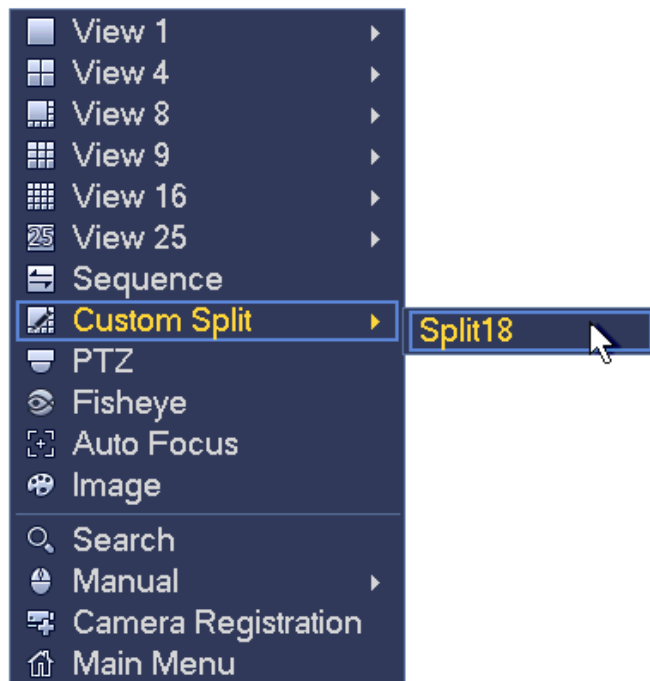

Figure 4-71

## 4.4 PTZ

### Note

Before you control the PTZ, please make sure the PTZ decoder and the NVR network connection is OK and the corresponding settings are right.

### 4.4.1 PTZ Settings

#### Cable Connection

Please follow the procedures below to go on cable connection

- Connect the dome RS485 port to NVR RS485 port.
- Connect dome video output cable to NVR video input port.
- Connect power adapter to the dome.

In the main menu, from Setting>System>PTZ, you can see an interface is shown as in Figure 4-76.

Here you can set the following items:

- Channel: Select the current camera channel.
- PTZ type: There are two types: local/remote. Please select local mode if you are connect RS485 cable to connect to the Speed dome (PTZ). Please select remote mode if you are connecting to the network PTZ camera.
- Protocol: Select corresponding PTZ protocol(such as PELCOD)

- Address: Default address is 1.
- Baud rate: Select corresponding baud rate. Default value is 9600.
- Data bit: Select corresponding data bits. Default value is 8.
- Stop bit: Select corresponding stop bits. Default value is 1.
- Parity: There are three options: odd/even/none. Default setup is none.



Figure 4-72

If you are connecting to network PTZ, the PTZ type shall be remote. See Figure 4-77.

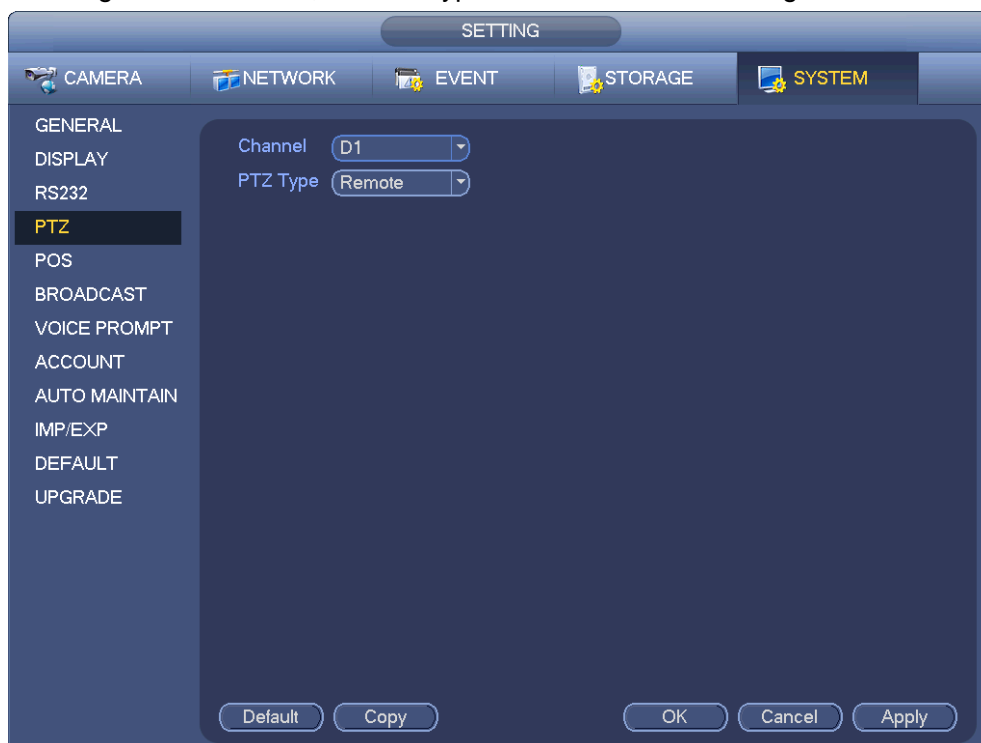

Figure 4-73

## 4.4.2 PTZ Control

After completing all the setting please click save button. Right click mouse (click “Fn” Button in the front panel or click “Fn” key in the remote control). The interface is shown as in Figure 4-78. Please note you can only go to the PTZ control interface when you are in 1-window display mode.

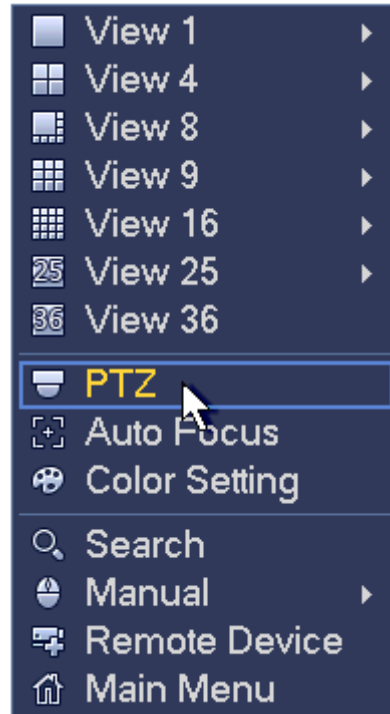

Figure 4-74



The PTZ setup is shown as in See Figure 4-79.

Please note the commend name is grey once device does not support this function.

The PTZ operation is only valid in one-window mode.

Here you can control PTZ direction, speed, zoom, focus, iris, preset, tour, scan, pattern aux function, light and wiper, rotation and etc.

Speed is to control PTZ movement speed. The value ranges from 1 to 8. The speed 8 is faster than speed 1. You can use the remote control to click the small keyboard to set.

You can click  and  of the zoom, focus and iris to zoom in/out, definition and brightness.

The PTZ rotation supports 8 directions. If you are using direction buttons on the front panel, there are only four directions: up/down/left/right.

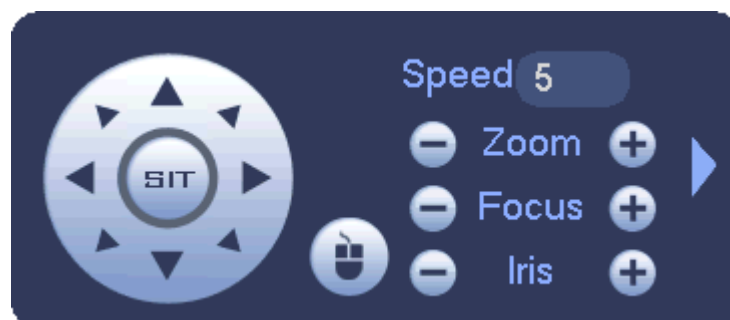

Figure 4-75

In the middle of the eight direction arrows, there is a 3D intelligent positioning key. See Figure 4-80. Please make sure your protocol supports this function and you need to use mouse to control. Click this key, system goes back to the single screen mode. Drag the mouse in the screen to adjust section size. The dragged zone supports 4X to 16X speeds. It can realize PTZ automatically. The smaller zone you dragged, the higher the speed.



Figure 4-76

Name	Function key	function	Shortcut key	Function key	function	Shortcut key
Zoom		Near			Far	
Focus		Near			Far	
Iris		close			Open	

In Figure 4-79, click to open the menu, you can set preset, tour, pattern, scan and etc. See Figure 4-81.



Figure 4-77

Please refer to the following sheet for detailed information.

Please note the above interface may vary due to different protocols. The button is grey and cannot be selected once the current function is null.

Right click mouse or click the ESC button at the front panel to go back to the Figure 4-79.

Icon	Function	Icon	Function
	Preset		Flip
	Tour		Reset
	Pattern		Aux

	Scan		Aux on-off button
	Rotate		Go to menu

### 4.4.2.1 PTZ Function Setup

Click , you can go to the following interface to set preset, tour, pattern, and scan. See Figure 4-82.



Figure 4-78

#### Preset Setup

In Figure 4-82, click preset button and use eight direction arrows to adjust camera to the proper position. The interface is shown as in Figure 4-83.

Click Set button and then input preset number.

Click Set button to save current preset.



Figure 4-79

#### Tour Setup

In Figure 4-82, click tour button.

Input tour value and preset No. Click Add preset button to add current preset to the tour. See Figure 4-84.

### Tips

Repeat the above steps to add more presets to the tour. Click Del preset button to remove it from the tour. Please note some protocols do not support delete preset function.



Figure 4-80

### Pattern Setup

In Figure 4-82, click Pattern button and input pattern number.

Click Begin button to start direction operation. Or you can go back to Figure 4-79 to operate zoom/focus/iris/direction operation.

In Figure 4-82, click End button.



Figure 4-81

### Scan Setup

In Figure 4-82, click Scan button.

Use direction buttons to set camera left limit and then click Left button.

Use direction buttons to set camera right limit and then click Right button. Now the scan setup process is complete.





Figure 4-82

### 4.4.2.2 Call PTZ Function



#### Call Preset

In Figure 4-81, input preset value and then click  to call a preset. Click  again to stop call.

#### Call Pattern

In Figure 4-81, input pattern value and then click  to call a pattern. Click  again to stop call.

#### Call Tour

In Figure 4-81, input tour value and then click  to call a tour. Click again  to stop call.

#### Call Scan

In Figure 4-81, input Scan value and then click  to call a tour. Click again  to stop call.

#### Rotate

In Figure 4-81, click  to enable the camera to rotate.  
System supports preset, tour, pattern, scan, rotate, light and etc function.

#### Note:

- Preset, tour and pattern all need the value to be the control parameters. You can define it as you require.
- You need to refer to your camera user's manual for Aux definition. In some cases, it can be used for special process.

#### Aux

Click , system goes to the following interface. The options here are defined by the protocol. The aux number is corresponding to the aux on-off button of the decoder. See Figure 4-87.



Figure 4-83

## 4.5 Record File

Device adopts 24-hour continuous record by default. It supports customized record period and record type. Refer to chapter 4.1.4.5 Schedule for detailed information.

## 4.6 Playback and Search

### 4.6.1 Instant Playback

Please refer to chapter 4.3.2 for real-time playback information.

### 4.6.2 Search Interface

From Main menu>Search, or on the preview interface right click mouse and then select search item, you can go to the following interface. See Figure 4-88 or Figure 4-89.



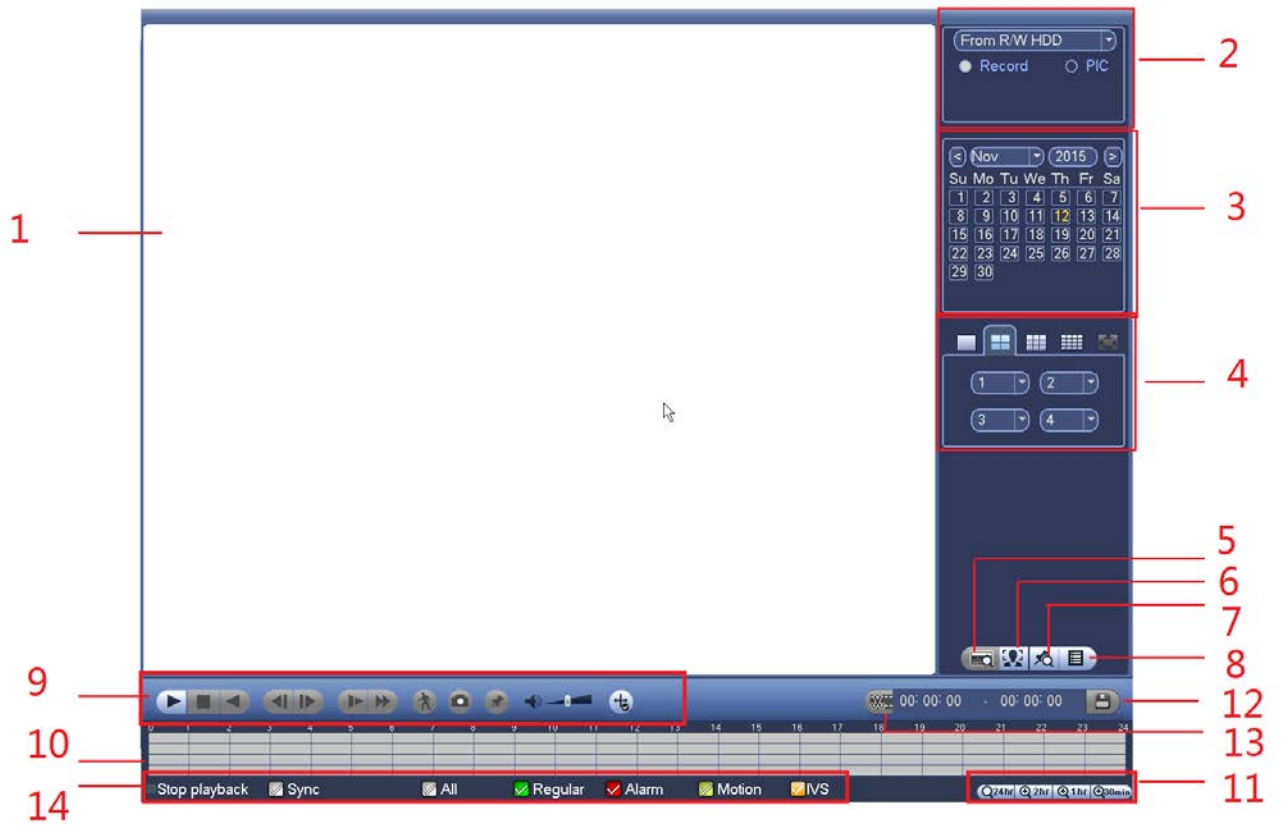

Figure 4-84

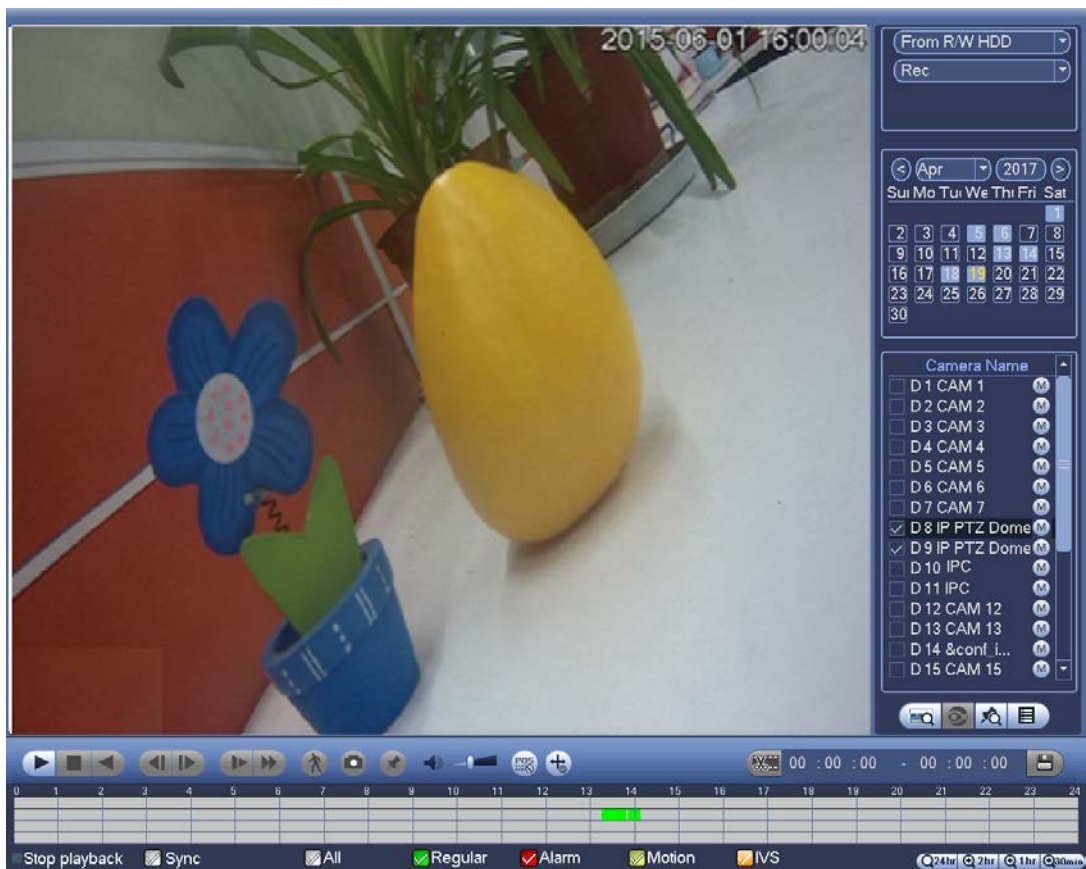
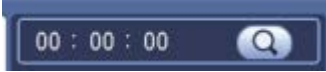

















Figure 4-85

Please refer to the following sheet for more information.

SN	Name	Function
1	Display window	<ul style="list-style-type: none"> <li>● Here is to display the searched picture or file.</li> <li>● Support 1/4/9/16-window playback. (It depends on the product channel amount).</li> </ul>
2	Search type	<ul style="list-style-type: none"> <li>● Here you can select to search the picture or the recorded file.</li> <li>● You can select to play from the read-write HDD, from peripheral device or from redundancy HDD.</li> <li>● Before you select to play from the peripheral device, please connect the corresponding peripheral device. You can view all record files of the root directory of the peripheral device. Click the Browse button; you can select the file you want to play.</li> </ul> <p><b>Important</b></p> <ul style="list-style-type: none"> <li>● <b>Redundancy HDD does not support picture backup function, but it supports picture playback function. You can select to play from redundancy HDD if there are pictures on the redundancy HDD.</b></li> </ul>
3	Calendar	<ul style="list-style-type: none"> <li>● The blue highlighted date means there is picture or file. Otherwise, there is no picture or file.</li> <li>● In any play mode, click the date you want to see, you can see the corresponding record file trace in the time bar.</li> </ul>
4	Playback mode and channel selection pane.	<ul style="list-style-type: none"> <li>● Playback mode:1/4/9/16. (It may vary due to different series.)</li> <li>◇ In 1-window playback mode: you can select 1-X channels (X depends on the product channel amount).</li> <li>◇ In 4-window playback mode: you can select 4 channels according to your requirement.</li> <li>◇ In 9-window playback mode, you can switch between 1-8, 9-16 and etc channels.</li> <li>◇ In 16-window playback mode, you can switch between 1-16, 17-32 and etc channels.</li> <li>● The time bar will change once you modify the playback mode or the channel option.</li> </ul>
5	Card number search	The card number search interface is shown as below. Here you can view card number/field setup bar. You can implement advanced search. <b>Current series product supports this function.</b>
6	Face list	You can search when it is in 1-channel playback mode. Click it, system can filter all human faces and generate human face list. Double click the file; system begins playback the record or image of the corresponding human face.
7	Mark file list button	Click it to go to mark file list interface. You can view all mark information of current channel by time. Please refer to chapter 4.6.4 for detailed information. Please note only the product of this icon supports mark function.

8	File list switch button	<ul style="list-style-type: none"> <li>● Double click it, you can view the picture/record file list of current day.</li> <li>● The file list is to display the first channel of the record file.</li> <li>● The system can display max 128 files in one time. Use the ◀  and  ▶ or the mouse to view the file. Select one item, and then double click the mouse or click the ENTER button to playback.</li> <li>● You can input the period in the following interface to begin accurate search.</li> <li>● File type:R—regular record ; A—external alarm record ; M—Motion detect record.</li> </ul>  <ul style="list-style-type: none"> <li>● Lock file. Click the file you want to lock and click the button  to lock. The file you locked will not be overwritten.</li> <li>● Search locked file: Click the button  to view the locked file.</li> </ul>	
9	Playback control pane.	▶/	<p>Play/Pause There are three ways for you to begin playback.</p> <ul style="list-style-type: none"> <li>● The play button</li> <li>● Double click the valid period of the time bar.</li> <li>● Double click the item in the file list.</li> </ul> <p>In slow play mode, click it to switch between play/pause.</p>
		■	Stop
		◀	<p>Backward play In normal play mode, left click the button, the file begins backward play. Click it again to pause current play. In backward play mode, click ▶/   to restore normal play.</p>
		◀/ ▶	<p>In playback mode, click it to play the next or the previous section. You can click continuously when you are watching the files from the same channel. In normal play mode, when you pause current play, you can click ◀  and  ▶ to begin frame by frame playback. In frame by frame playback mode, click ▶/   to restore normal playback.</p>
		▶·	<p>Slow play In playback mode, click it to realize various slow play modes such as slow play 1, slow play 2, and etc.</p>
		▶▶	<p>Fast forward In playback mode, click to realize various fast play modes such as fast play 1,fast play 2 and etc.</p>
		Note: The actual play speed has relationship with the software version.	
			Smart search
			The volume of the playback

		 <p>Click the snapshot button in the full-screen mode, the system can snapshot 1 picture.</p> <p>System supports custom snap picture saved path. Please connect the peripheral device first, click snap button on the full-screen mode, you can select or create path. Click Start button, the snapshot picture can be saved to the specified path.</p>
		 <p>Mark button.</p> <p>Please note this function is for some series product only. Please make sure there is a mark button in the playback control pane.</p> <p>You can refer to chapter 4.6.4 for detailed information.</p>
		 <p>In 1-channel playback mode, click it to enable/disable display IVS rule information on the video.</p>
10	Time bar	<ul style="list-style-type: none"> <li>● It is to display the record type and its period in current search criteria.</li> <li>● In 4-window playback mode, there are corresponding four time bars. In other playback mode, there is only one time bar.</li> <li>● Use the mouse to click one point of the color zone in the time bar, system begins playback.</li> <li>● The time bar is beginning with 0 o'clock when you are setting the configuration. The time bar zooms in the period of the current playback time when you are playing the file.</li> <li>● The green color stands for the regular record file. The red color stands for the external alarm record file. The yellow stands for the motion detect record file.</li> </ul>
11	Time bar unit	<ul style="list-style-type: none"> <li>● The option includes: 、、 和 。The smaller the unit, the larger the zoom rate. You can accurately set the time in the time bar to playback the record.</li> <li>● The time bar is beginning with 0 o'clock when you are setting the configuration. The time bar zooms in the period of the current playback time when you are playing the file.</li> </ul>
12	Backup	<ul style="list-style-type: none"> <li>● Select the file(s) you want to backup from the file list. You can check from the list. Then click the backup button, now you can see the backup menu. System supports customized path setup. After select or create new folder, click the Start button to begin the backup operation. The record file(s) will be saved in the specified folder.</li> <li>● Check the file again you can cancel current selection. System max supports to display 32 files from one channel.</li> <li>● After you clip on record file, click Backup button you can save it.</li> <li>● For one device, if there is a backup in process, you cannot start a new backup operation.</li> </ul>
13	Clip	<p>It is to edit the file.</p> <ul style="list-style-type: none"> <li>● Please click  to play the file you want to edit.</li> <li>● Select clip start time on the time bar and then Click  to start clip.</li> </ul>

		<ul style="list-style-type: none"> <li>● Select clip stop time on the time bar and then click  to stop clip.</li> <li>● Click , system pops up file backup dialogue box for you to save.</li> </ul> <p>Please note:</p> <ul style="list-style-type: none"> <li>● <b>Clip function is for one-channel mode/multiple-channel mode.</b></li> <li>● <b>System max supports 1024 files backup at the same time.</b></li> <li>● <b>You cannot operate clip operation if there is any file has been checked in the file list.</b></li> </ul>
14	Record type	In any play mode, the time bar will change once you modify the search type.
<b>Other Functions</b>		
15	Motion detection search	<ul style="list-style-type: none"> <li>● When system is playing, you can select a zone in the window to begin motion detection search. Click the motion detect button to begin play.</li> <li>● Once the motion detect play has begun, click button again will terminate current motion detect file play.</li> <li>● There is no motion detect zone by default.</li> <li>● If you select to play other file in the file list, system switches to motion detect play of other file.</li> <li>● During the motion detect play process, you cannot implement operations such as change time bar, begin backward playback or frame by frame playback.</li> </ul>
16	Other channel synchronization switch to play when playback	When playing the file, click the number button, system can switch to the same period of the corresponding channel to play.
17	Digital zoom	When the system is in full-screen playback mode, left click the mouse in the screen. Drag your mouse in the screen to select a section and then left click mouse to realize digital zoom. You can right click mouse to exit.
18	Manually switch channel when playback	During the file playback process, you can switch to other channel via the dropdown list or rolling the mouse. This function is null if there is no record file or system is in smart search process.

 **Note**

All the operations here (such as playback speed, channel, time and progress) have relationship with hardware version. Some series NVRs do not support some functions or playback speeds.

## 4.6.2.1 Playback Control



The playback control interface is shown as below. See Figure 4-90.



Figure 4-86

Please refer to the following sheet for more information.

Icon	Function
	Play/Pause In slow play mode, click it to switch between play/pause.
	Backward play <ul style="list-style-type: none"> <li>In normal play mode, left click the button, the file begins backward play. Click it again to pause current play.</li> <li>In backward play mode, click  or  to restore normal play.</li> </ul>
	Display previous frame/next frame. <ul style="list-style-type: none"> <li>When pause the normal playback file, click  or  to playback frame by frame.</li> <li>In frame by frame playback mode, click  or  to resume normal playback mode.</li> </ul>
	Slow play In playback mode, click it to realize various slow play modes such as slow play 1, slow play 2, and etc.
	Fast forward In playback mode, click to realize various fast play modes such as fast play 1, fast play 2 and etc.
	Adjust the volume of the playback
	Smart search . You can refer to chapter 4.6.3 for detailed information.
	Click the snapshot button in the full-screen mode, the system can snapshot 1 picture. System supports custom snap picture saved path. Please connect the peripheral device first, click snap button on the full-screen mode, you can select or create path. Click Start button, the snapshot picture can be saved to the specified path.
	Mark button. Please note this function is for some series product only. Please make sure there is a mark button in the playback control pane. You can refer to chapter 4.6.4 for detailed information.

Icon	Function
	Display/hide POS information. In 1-channel playback mode, you can click it to display/hide POS information on the video.
	<b>Note</b> This function is for some series only. In 1-channel playback mode, click it to enable/disable display IVS rule information on the video.

### 4.6.2.2 Clip

This function allows you to clip some footages to a new file and then save to the USB device. See Figure 4-91. Please follow the steps listed below.

Step 1 Select a record first and then click  to playback.

Step 2 Select a time at the time bar and then click  to start clip,

Step 3 Select a time at the time bar and then click  to stop clip,

Step 4 Click , system pops up dialogue box to save the clip file.



Figure 4-87

#### Note

- Clip function is for one-channel/multiple-channel.
- Max save 1024 files at the same time.
- This function is not for the file already checked in the file list.

### 4.6.2.3 Record Backup

This function is to backup files you checked in the file list, or the file you just clip.

Click , enter the following interface. See Figure 4-92.

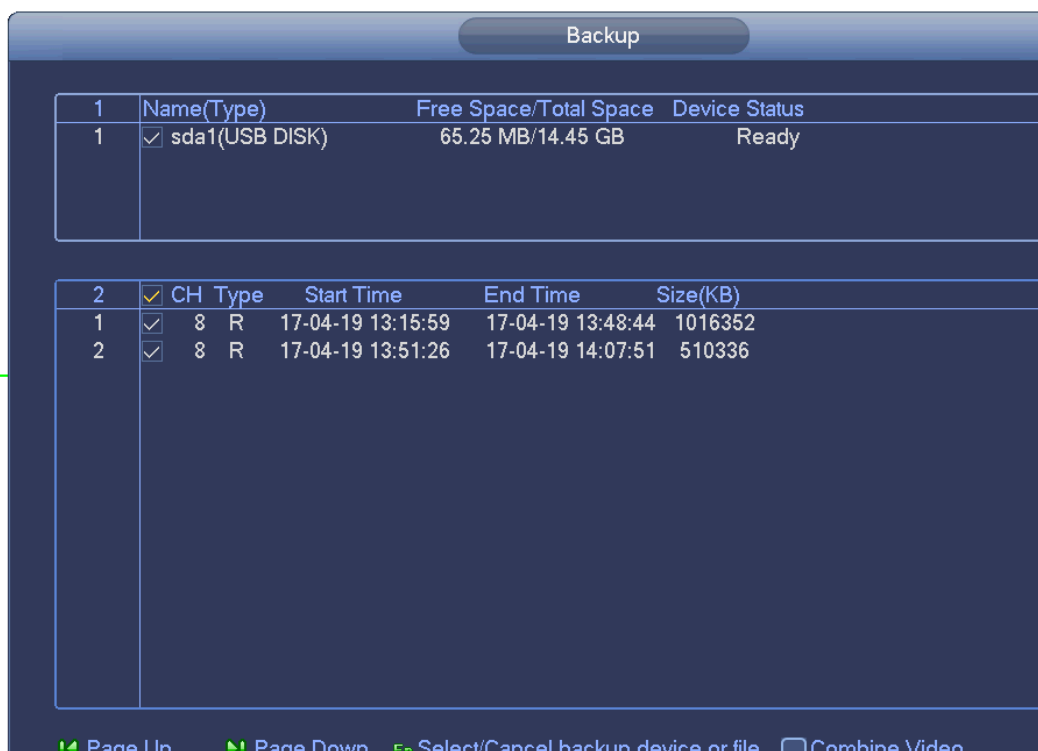

Figure 4-88

Click Backup to begin the process.

### 4.6.3 Smart Search Playback

 **Note**

This function is for some series product only.

During playback process, it can analyze the motion detect zone in the scene and give the analysis result.

This function is for channel that already enabled motion detect function (main menu>Setting>Event>Video detect>Motion detect).

Please follow the steps listed below.

Step 1 Select a channel to playback video and then click . You can view the grids on the playback video.

 **Note**

- This function is for one-channel playback mode.
- If you are in multiple-channel playback mode, double click a channel first to switch to one-channel playback mode.

Step 2 Left click mouse and then drag to select smart search zones(22\*18(PAL), 22\*15(NTSC)).



Step 3 Click  to go to smart search and playback. System is going to playback all motion detect record footages.

Step 4 Click  again to stop smart search function.

## 4.6.4 Mark Playback

**Please make sure your purchased device support this function. You can use this function only if you can see the mark playback icon on the Search interface (Figure 4-88 or Figure 4-89).**

When you are playback record, you can mark the record when there is important information. After playback, you can use time or the mark key words to search corresponding record and then play. It is very easy for you to get the important video information.

- Add Mark

When system is playback, click Mark button , you can go to the following interface. See Figure 4-93.

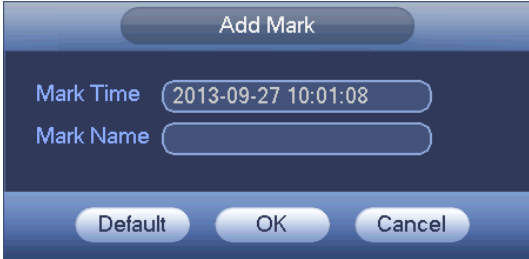



Figure 4-89

- Playback Mark

During 1-window playback mode, click mark file list button  in Figure 4-88 or Figure 4-89, you can go to mark file list interface. Double click one mark file, you can begin playback from the mark time.

- Play before mark time

Here you can set to begin playback from previous N seconds of the mark time.

### Note

Usually, system can playbacks previous N seconds record if there is such kind of record file. Otherwise, system playbacks from the previous X seconds when there is such as kind of record.

- Mark Manager

Click the mark manager button  on the Search interface (Figure 4-88 or Figure 4-89); you can go to Mark Manager interface. See Figure 4-94. System can manage all the record mark information of current channel by default. You can view all mark information of current channel by time.

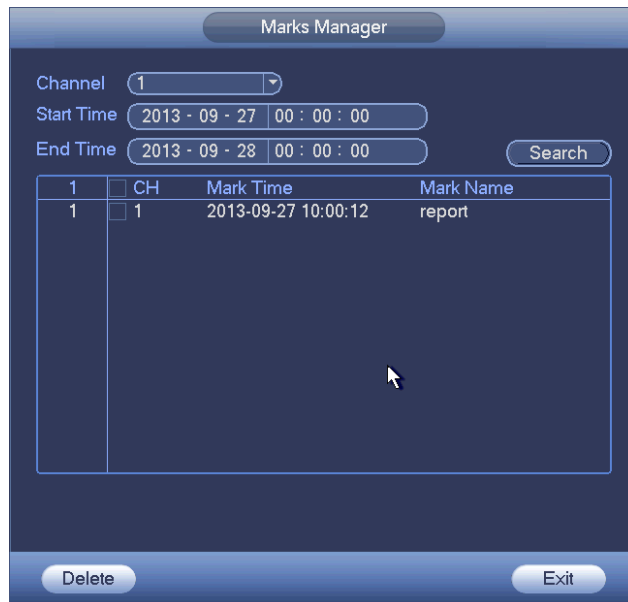

Figure 4-90

- **Modify**

Double click one mark information item, you can see system pops up a dialogue box for you to change mark information. You can only change mark name here.

- **Delete**

Here you can check the mark information item you want to delete and then click Delete button, you can remove one mark item. .



**Note**

- After you go to the mark management interface, system needs to pause current playback. System resume playback after you exit mark management interface.
- If the mark file you want to playback has been removed, system begins playback from the first file in the list.

## 4.6.5 Playback Image

Here you can search and play the image. Please follow the steps listed below.

Step 1 From main menu>Search, or on the preview window right click mouse and then click Search, you can go to the search interface.

Step 2 At the top right corner, select image and then input playback interval.

Step 3 Select date and channel, click  to play.

## 4.6.6 Splice Playback

For the large record file, you can use splice playback function to play the same file in several sections at the same time. It is very convenient for you to find the video footages you desire.

On the main menu, click Search button, or right click mouse and then select Search. You can go to Figure 4-88 or Figure 4-89

On the right pane, check the box to enable splice playback function, and then set channel, date, split mode. The splice playback interface is shown as below. Each section has a small triangle; you can adjust it to set time. See Figure 4-95.



Figure 4-91



### Note

Select split mode, so that the record can be spliced in several sections.

Select splice file.

- Click Playback, system playbacks from the first of current date by default.
- Click time bar, system playbacks from the time you click.
- Click , you can select on the file list.



### Note

- The splice playback is for 1-window playback mode.
- System supports 1/4/8/16-split mode. Slight different may be found here. The 4-channel series product supports 4-split mode. The 8-channel series product support 8-split mode. The 16-channel or higher series product supports 16-split mode.
- The min period of each section is 5 minutes. For the record is less than 20 minutes, if you select 4-split mode (or more than 4-split mode), system can auto adjust so that the each section period is 5 minutes. In this situation, some channel may have no video.

## 4.6.7 Smart Search

It is to search and playback the IVS file, human face file, human body file and plate recognition record.



### Note

- There are two types to realize intelligent analytics function.
- ◇ Smart network camera supports intelligent functions: Some smart camera supports the intelligent functions. For NVR, it just displays the intelligent alarm information from the smart network camera and set or playback the record file.

- ✧ NVR supports intelligent functions: The connected network camera does not support intelligent video analytics function. The NVR supports the analytics function.
- This function is to playback the intelligent record file of the smart camera.

### 4.6.7.1 IVS

IVS extracts the key information in video based on image processing and analysis, and matches it with the preset detection rules. You can screen out and play the videos matching the rules.

Step 1 From main menu > Operation > Smart Search > IVS.

Enter the IVS interface. See Figure 4-96.

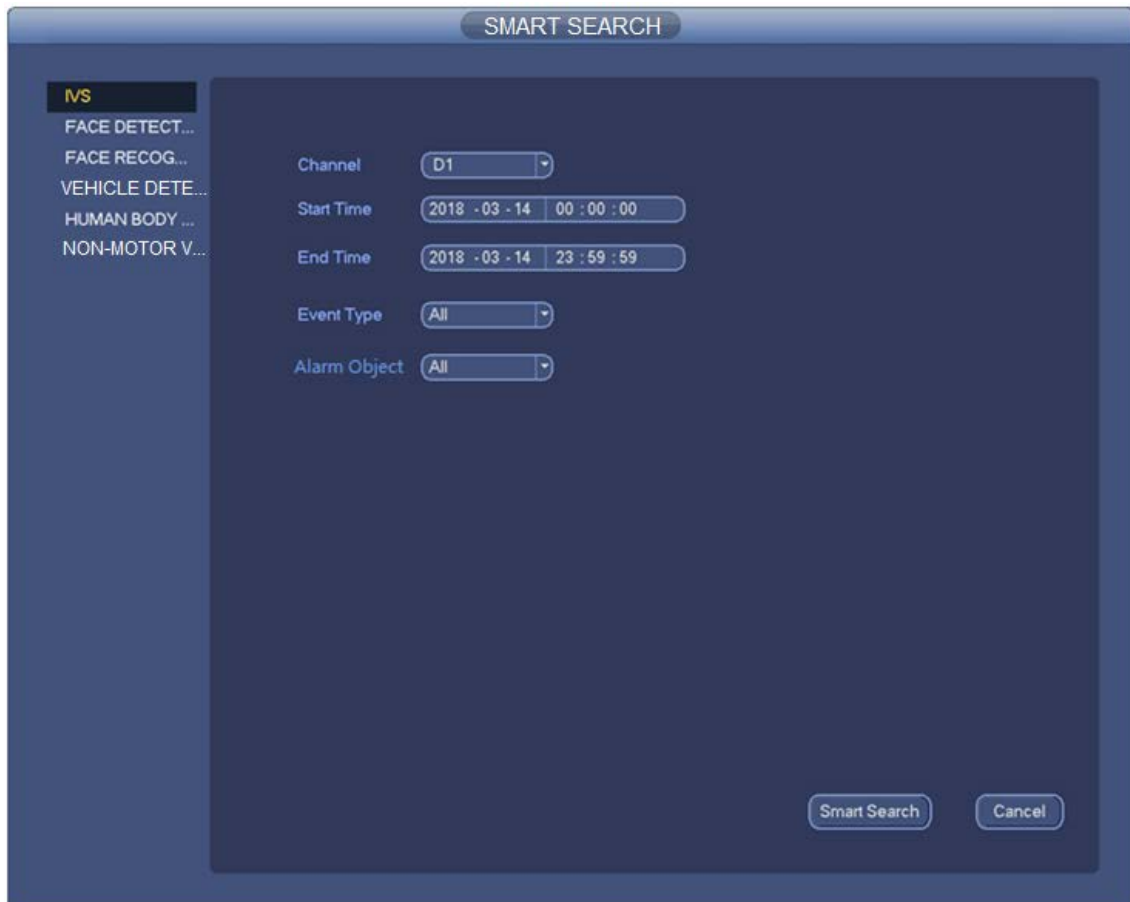

Figure 4-92

- Step 2 Select Channel, Start Time, End Time, Event Type and Alarm Object. Click Smart Search. The search results are displayed. See Figure 4-97.

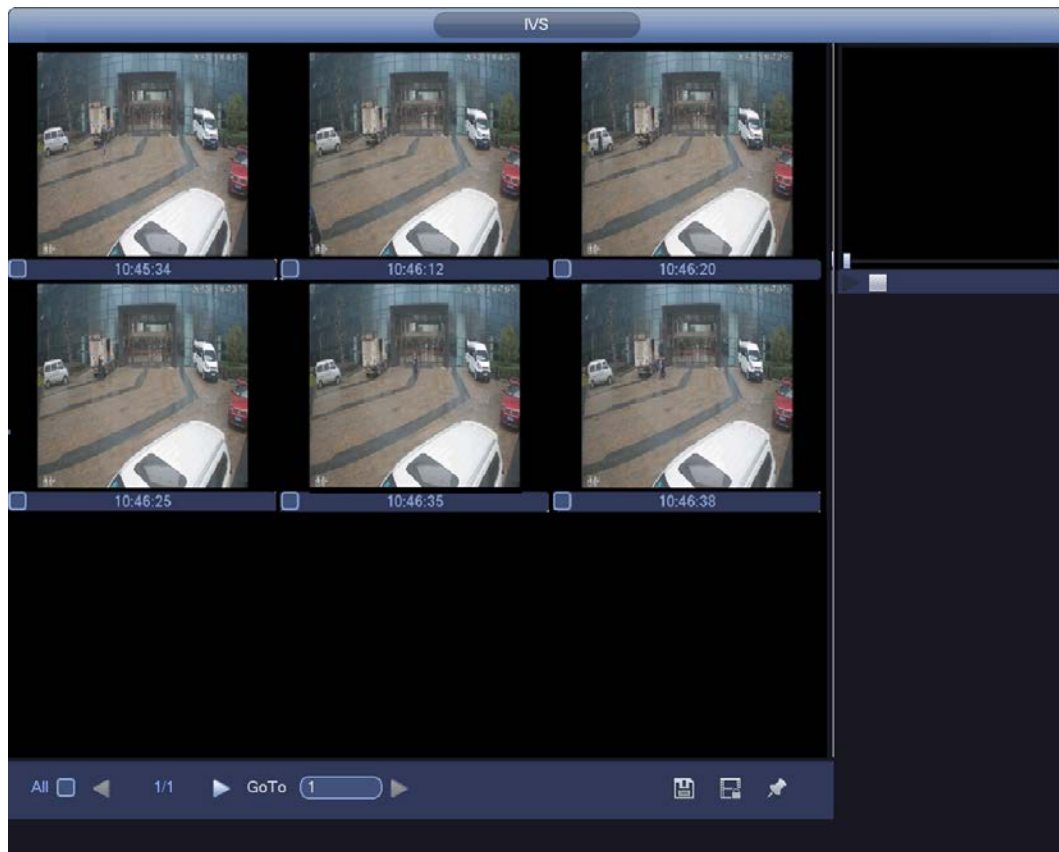

Figure 4-93

Step 3 Click the picture to play the video file.



- Select the file, click  and select the backup catalog in the backup interface. Select backup type and file type, choose the file and click Start to save the file to an external storage device. See Figure 4-98.



Figure 4-94

- Select a file and click  to lock the current file in case it will be overwritten in the future.
- Select a file and click  to mark the current time in the file.

#### 4.6.7.2 Face Detection

Human face detection is to analyze the video from the camera and check if there is any human face. It is to search and playback human face record.

- Step 1 From main menu > Operation > Smart Search > Face Detection.  
Enter the Face Detection interface. See Figure 4-99.



Figure 4-95

- Step 2 Select Channel, Start Time and End Time, and choose the details for face detection as needed, such as gender, age, glasses, mask, and beard. Click Smart Search. The results are displayed. See Figure 4-100.

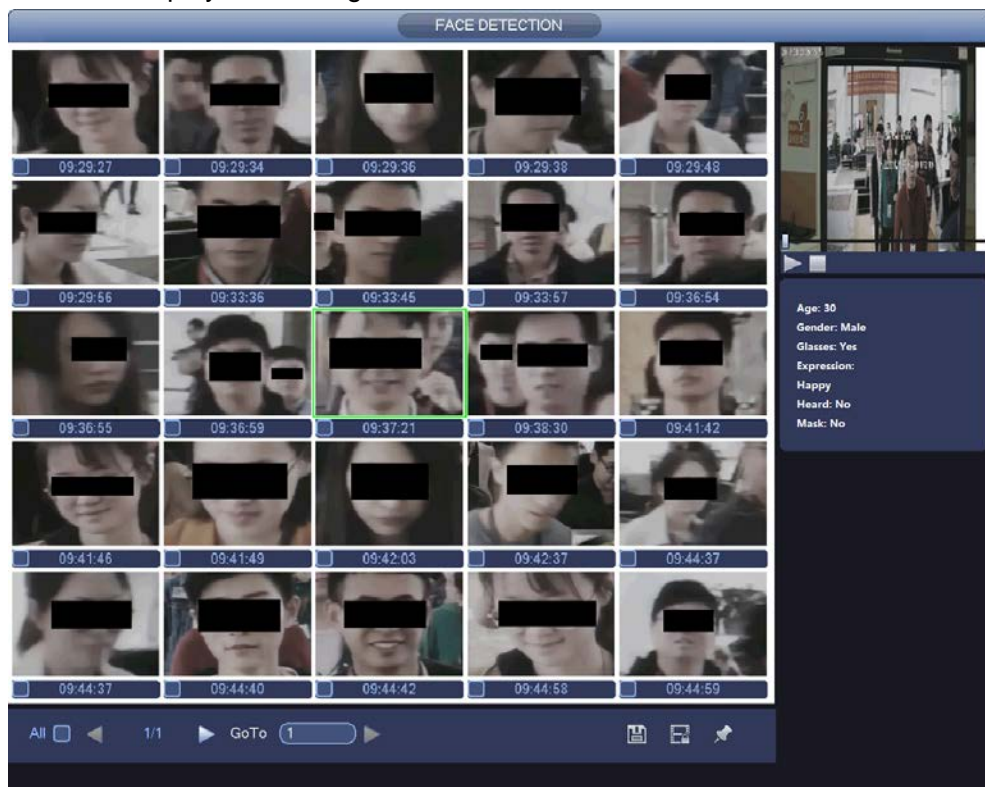





Figure 4-96



NOTE

The black blocks in the above picture is for privacy protection which will not appear in actual snapped images.

Step 3 Click the image; you can view the record file.

- Select a file and click  to save the current file to peripheral storage device.
- Select a file and click  to lock the current file in case it will be overwritten in the future.
- Select a file and click  to mark the current time in the file.
- You can view more information in Face Properties and Person Details.

### 4.6.7.3 Face Recognition

System supports to detect and compare the faces in the video with those in the database and play back the records. Smart detection includes searching by attribute and searching by image.



NOTE

Only some devices support this function.

#### 4.6.7.3.1 Searching by Attribute

Step 1 From main menu > Operation > Smart Search > Face Recognition > Search by Attributes.  
The Search by Attributes interface is displayed. See Figure 4-101.





Figure 4-97

- Step 2 Select the channel in the Channel drop-down list and configure the search parameters.
- Step 3 Click Smart Search.  
The results are displayed. See Figure 4-102.

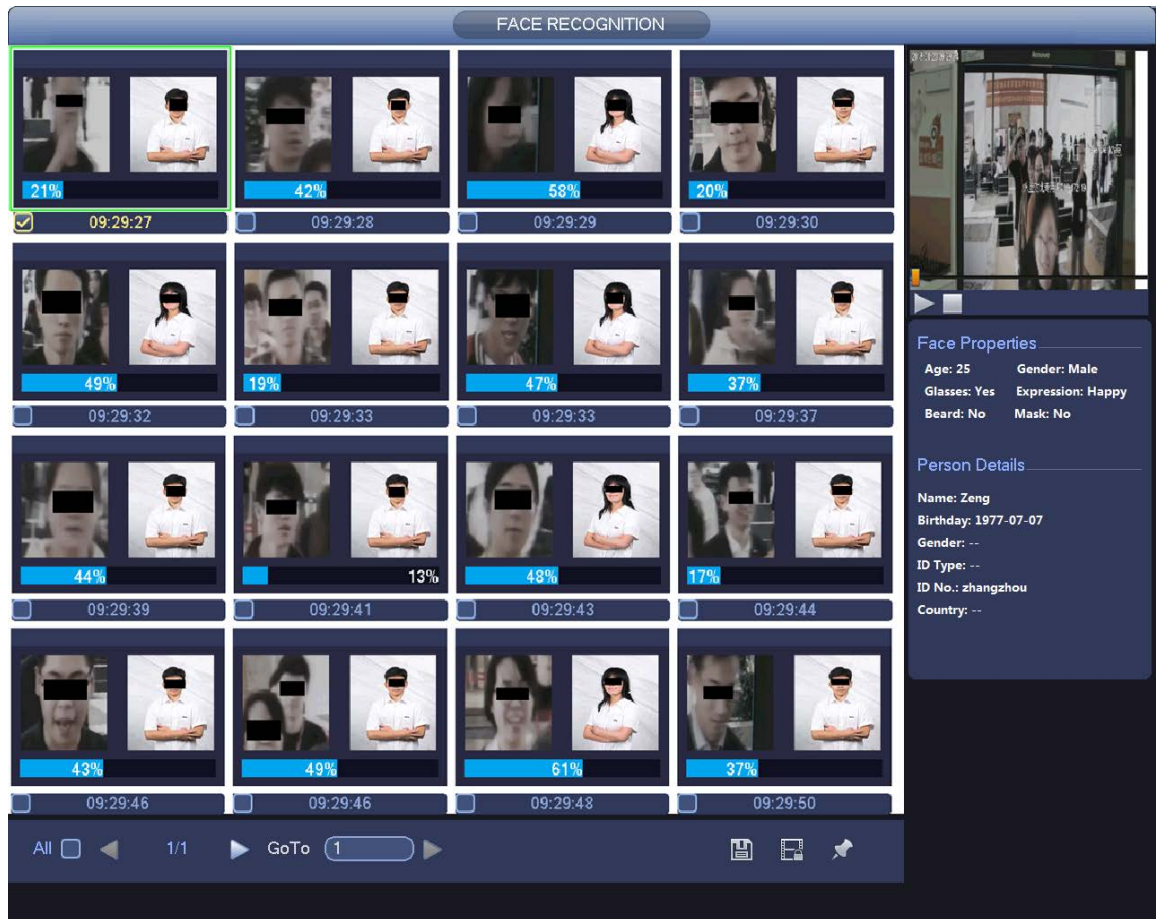





Figure 4-98

 NOTE

The black blocks in the above picture is for privacy protection which will not appear in actual snapped images.

Step 4 Click the image and the system starts to play the record to which the image belongs to.

- Select the file, click  and select the backup catalog in the backup interface. Select backup type and file type, choose the file and click Start to save the file to an external storage device.
- Select a file and then click . You can lock the current file in case it will be overwritten.
- Select a file and then click . You can mark the time of the detected event.
- You can view more information in Face Properties and Person Details.

#### 4.6.7.3.2 Searching by Image

Step 1 From main menu > Operation > Smart Search > Face Recognition > Search by Image. The Search by Image interface is displayed. See Figure 4-103.

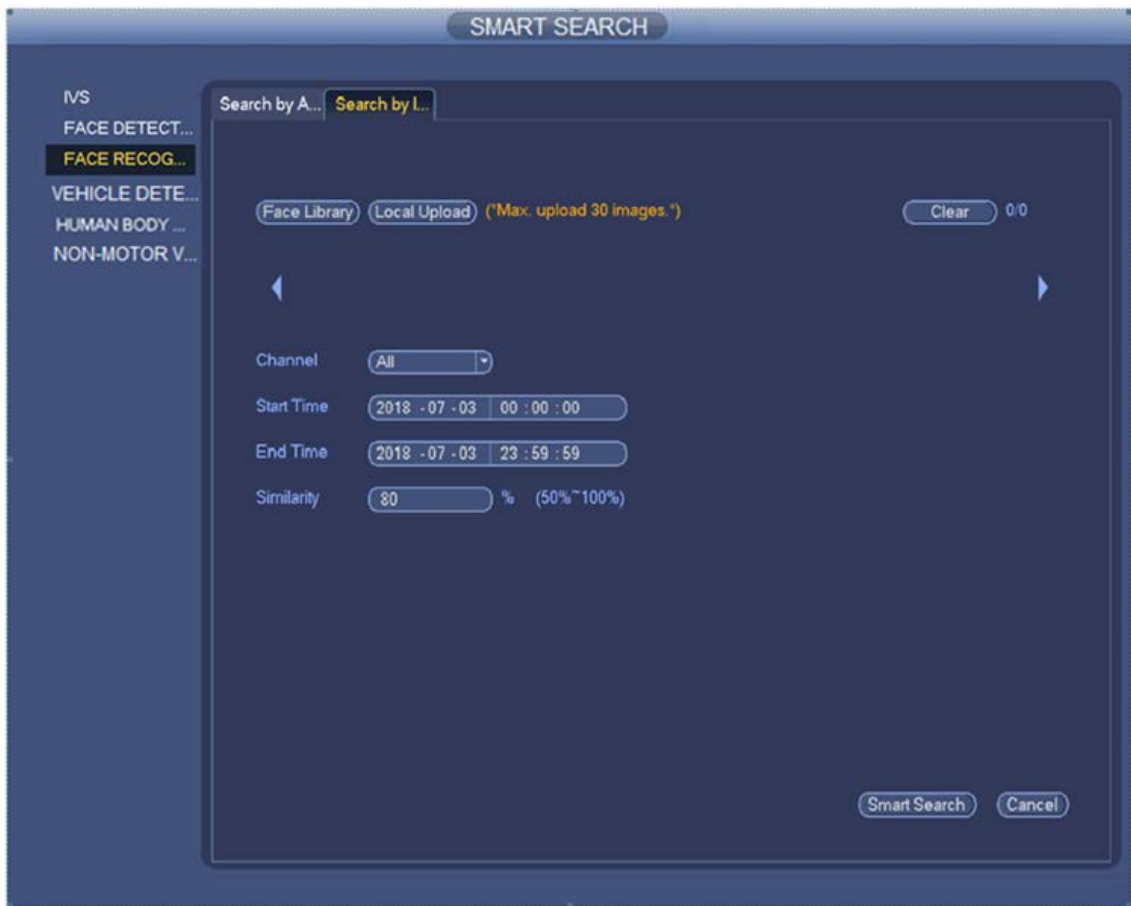

Figure 4-99

Step 2 Upload the image for detection. The system supports face library upload and local upload.

- Face Library

1. Click Face Library.

The Face Library interface is displayed. See Figure 4-104.



Figure 4-100

2. Configure the parameters, including name, gender, group name and certificate number.
3. Click Search and the results are displayed.
4. Select the image and click OK.  
The Search by Image interface is displayed again. See Figure 4-105.



Figure 4-101

- Local Upload:

Click Local Upload, select the image and click OK to upload the image.

NOTE

You can upload 30 images at most for each search.

Step 3 After uploading the image, configure the other parameters.

Step 4 Click Smart Search and the results are displayed. See Figure 4-106.



Figure 4-102

Step 5 Select the corresponding record and click  to play this record. See Figure 4-107.



Figure 4-103

#### 4.6.7.4 Vehicle Detection

 NOTE

Only some devices support this function.

Vehicle detection uses video image recognition technology to extract information such as license plate number, vehicle color, vehicle model, vehicle logo, plate color, vehicle decorations, calls and seat belts in the video image, and matches with preset search parameters. You can search and play back the record of a particular vehicle or the record of all vehicles.

Step 1 From main menu > Operation > Smart Search > Vehicle Detection.

The Vehicle Detection interface is displayed. See Figure 4-108.

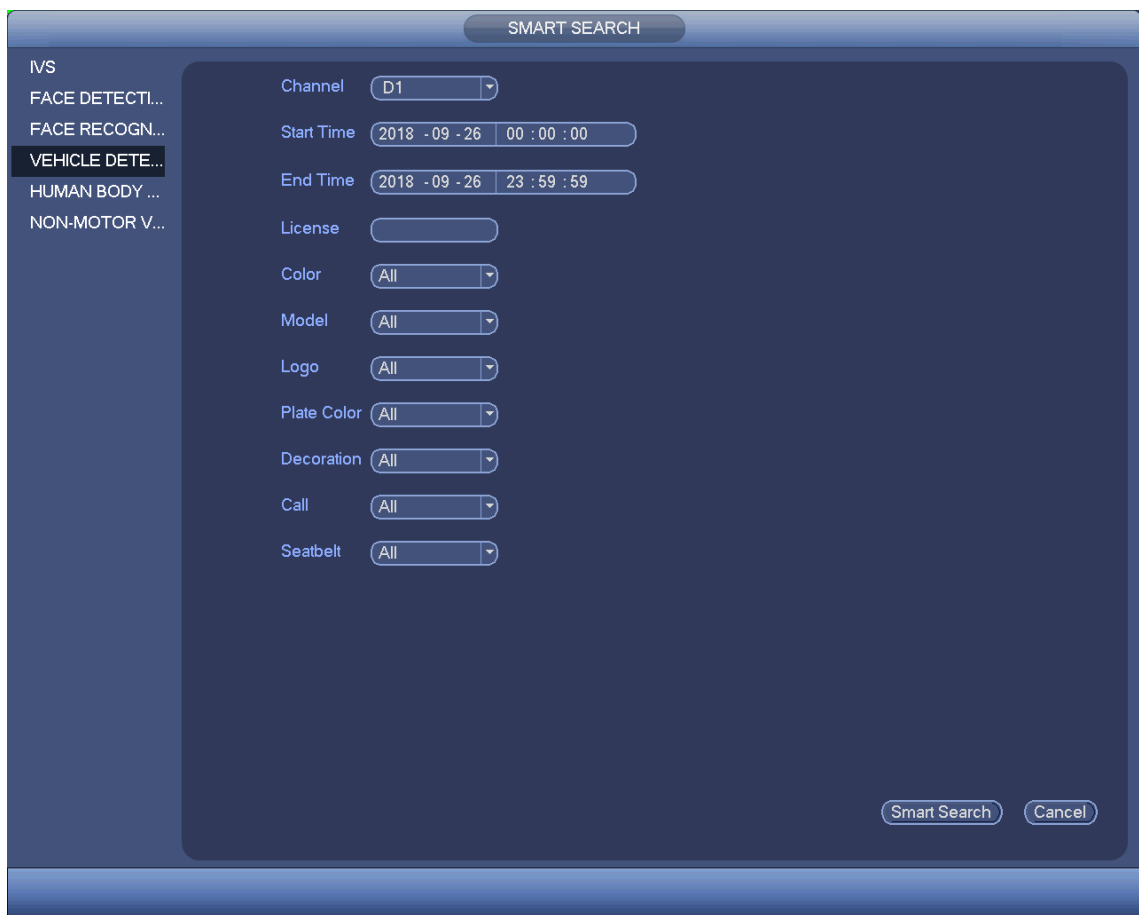

Figure 4-104

Step 2 Select the channel and set the search parameters according to the actual needs.

NOTE

- The system supports fuzzy plate number search.
- The device searches all plate numbers by default if you do not enter the plate number.

Step 3 Click Smart Search.

Device displays the corresponding images. See Figure 4-109.

NOTE

For privacy protection, the images and plate numbers here have been occluded.



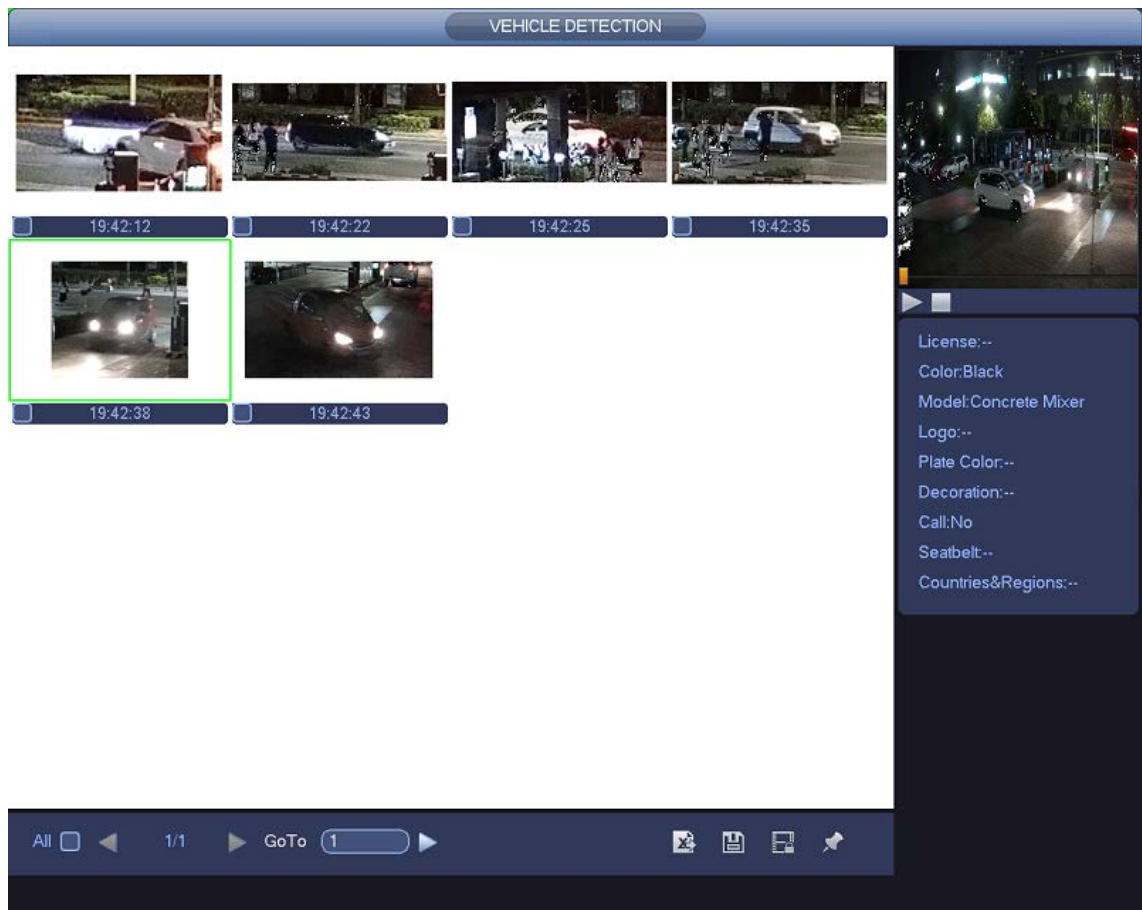

Figure 4-105

Step 4 Click the image and you can view the record file.





- Click . Select Device Name and Address in the Browse interface and click OK to export plate information. See Figure 4-110.





Figure 4-106

- Select a file and click  to save the current file to peripheral storage device.
- Select a file and click  to lock the current file in case it will be overwritten in the future.
- Select a file and click  to mark the current time in the file.

#### 4.6.7.5 Human Body Detection

Through the analysis and processing of video images collected by the camera, the system can detect if any human body exists in the images. You can screen out and replay the records with human body.

Step1 From main menu > Operation > Smart Search > Human Body Recognition.

The Human Body Recognition interface is displayed. See Figure 4-111.

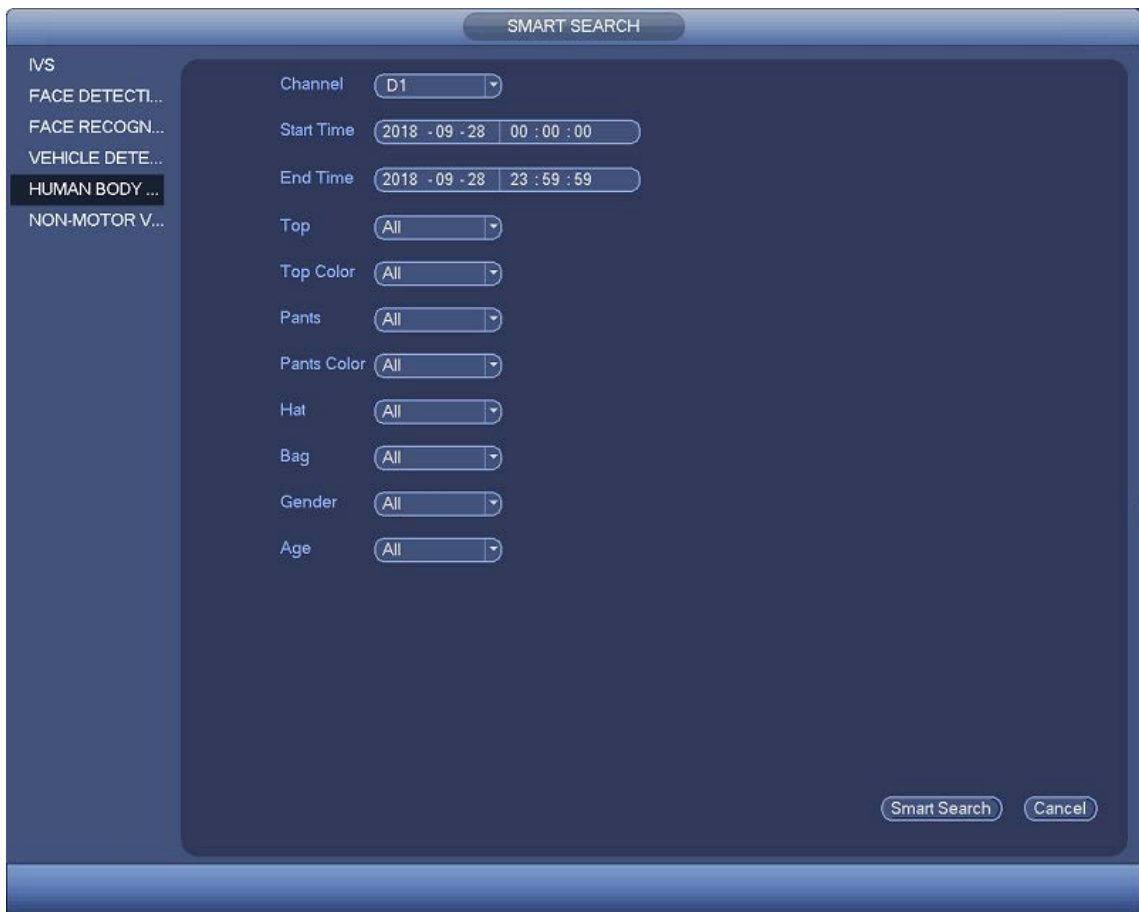

Figure 4-107

- Step2 Select Channel, Start Time and End time. Select the human details according to actual needs, such as Top Type, Top Color, Pants Type, Pants Color, Hat and Bag. Click Smart Search. The search results are displayed. See Figure 4-112.

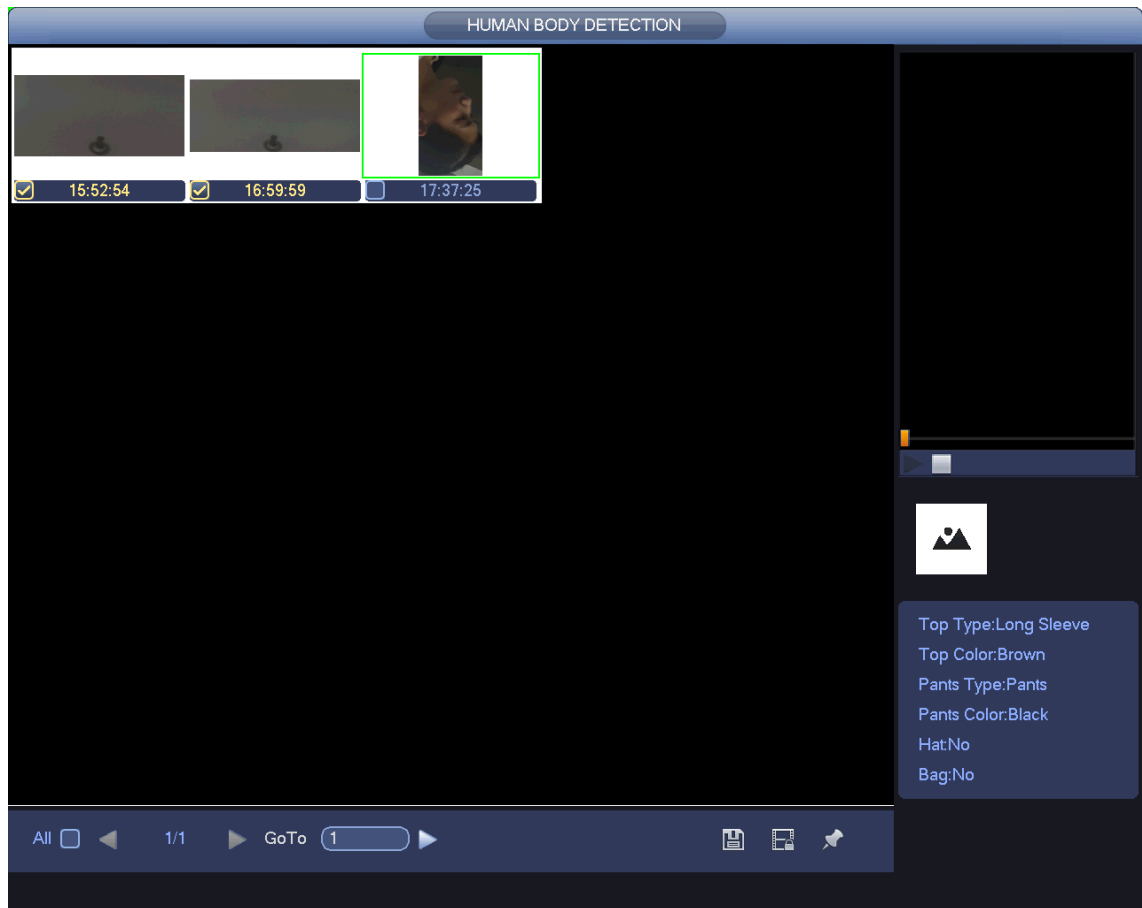





Figure 4-108

Step3 Click the image and you can view the record file.

- Select a file and click  to save the current file to peripheral storage device.
- Select a file and click  to lock the current file in case it will be overwritten in the future.
- Select a file and click  to mark the current time in the file.

#### 4.6.7.6 Non-Motor Vehicle Detection

 NOTE

Only some devices support this function.

Non-motor vehicle detection uses video image recognition technology to extract information such as non-motor vehicle model, color and number of people in the video image, and match with the preset search parameters. You can search and play back the record of a particular non-motor vehicle or the record of all non-motor vehicles.

Step 1 Enter from main menu > Operation > Smart Search > Non-Motor Detection.

The Non-Motor Detection interface is displayed. See Figure 4-113.

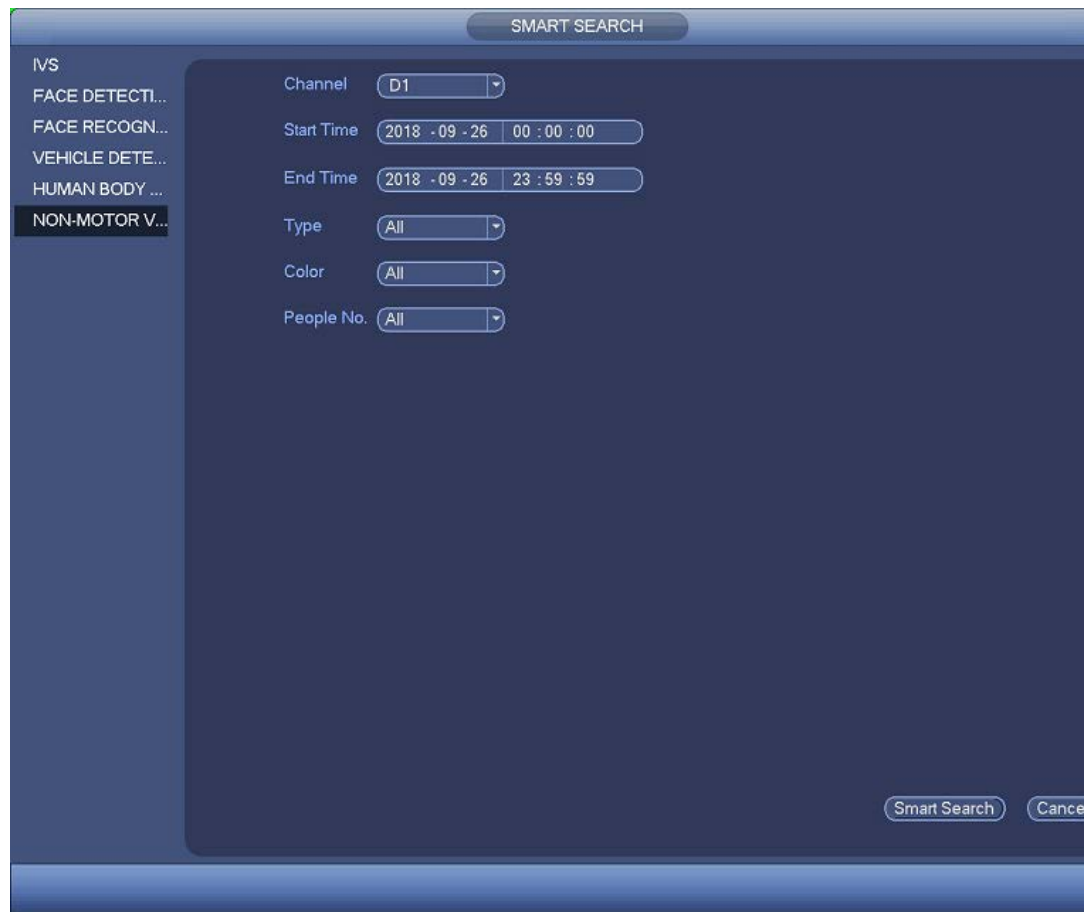

Figure 4-109

- Step 2 Select the channel and set the search parameters according to the actual needs.
- Step 3 Click Smart Search.  
The pictures meeting the criteria are displayed. See Figure 4-114.

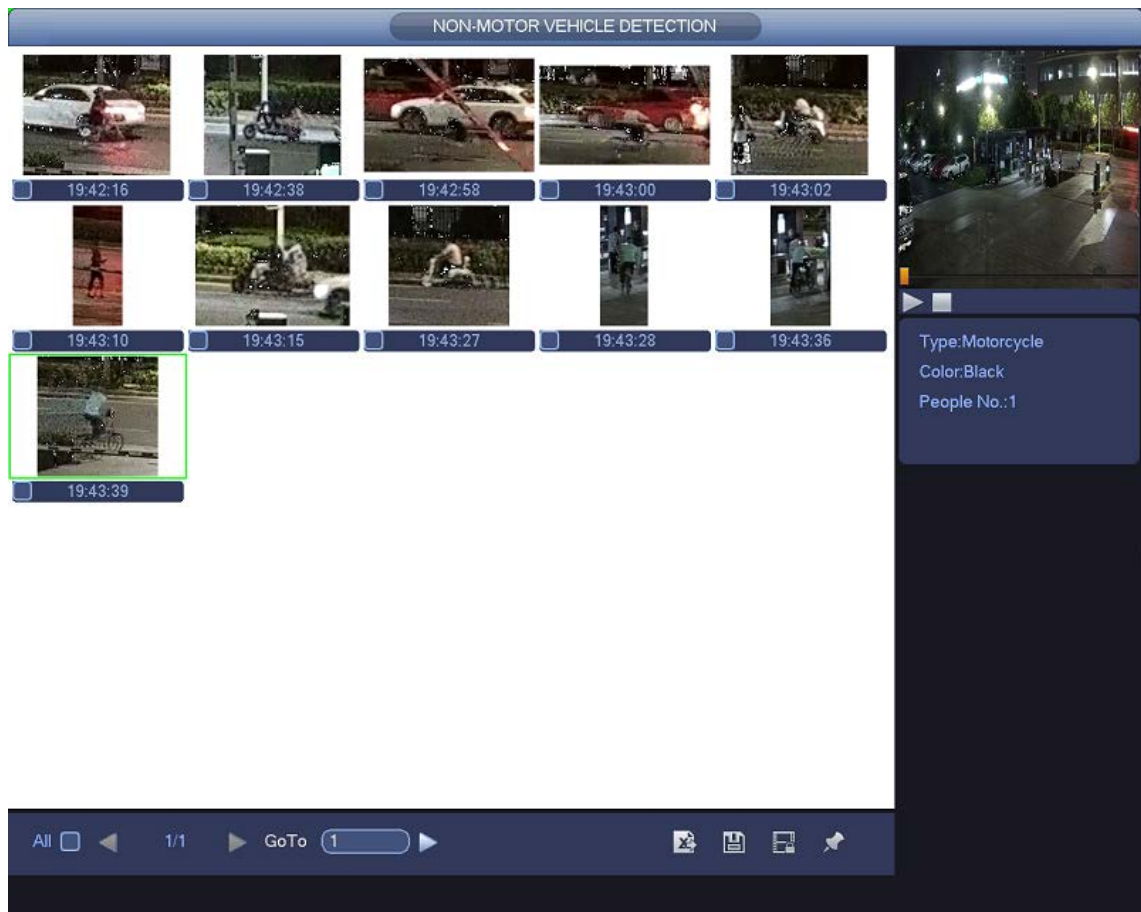



Figure 4-110

Step 4 Click the image and you can view the record file.

- Click . Select Device Name and Address in the Browse interface and click OK to export plate information. See Figure 4-110.

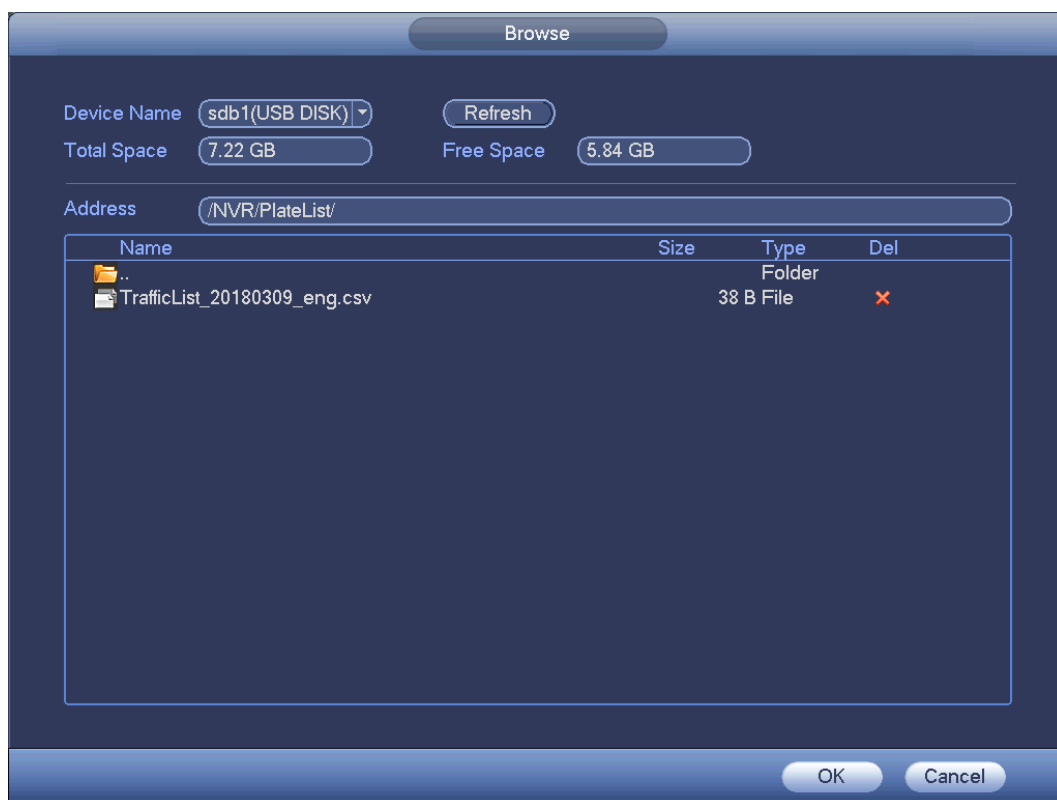





Figure 4-111

- Select a file and click  to save the current file to peripheral storage device.
- Select a file and click  to lock the current file in case it will be overwritten in the future.
- Select a file and click  to mark the current time in the file.

## 4.6.8 File List

Click , system displays file list. It displays the first channel of the record. See Figure 4-116.

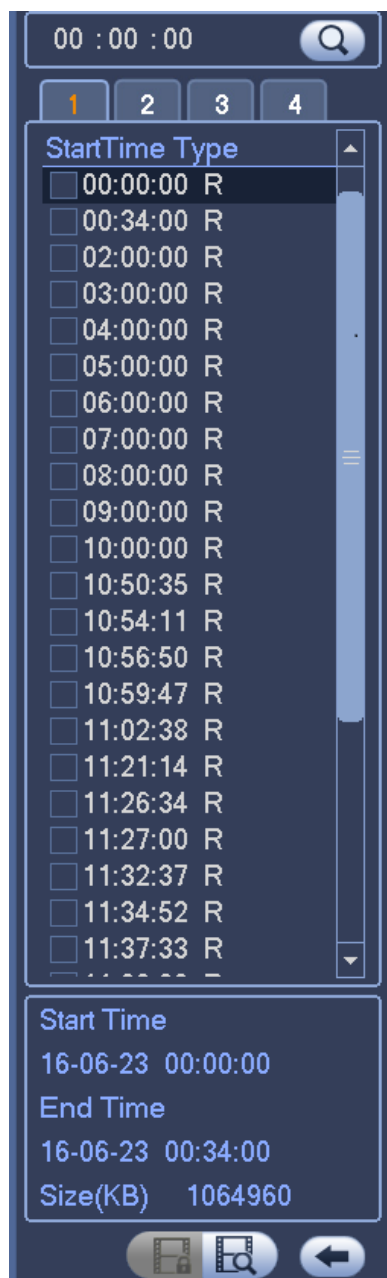





Figure 4-112

- Check a file name, double click file or click  to play.
- Input accurate time at the top column, you can search records of current day.
- System max displays 128 record files in one list.
- Click  to go back to the calendar/channel selection interface.

### Lock or Unlock File

In Figure 4-116, select a file first and then click . You can lock it in case it is overwritten in the future.

#### Note

NVR cannot lock a file when it is writing or overwriting.

Click  you can view the locked file. See Figure 4-117.

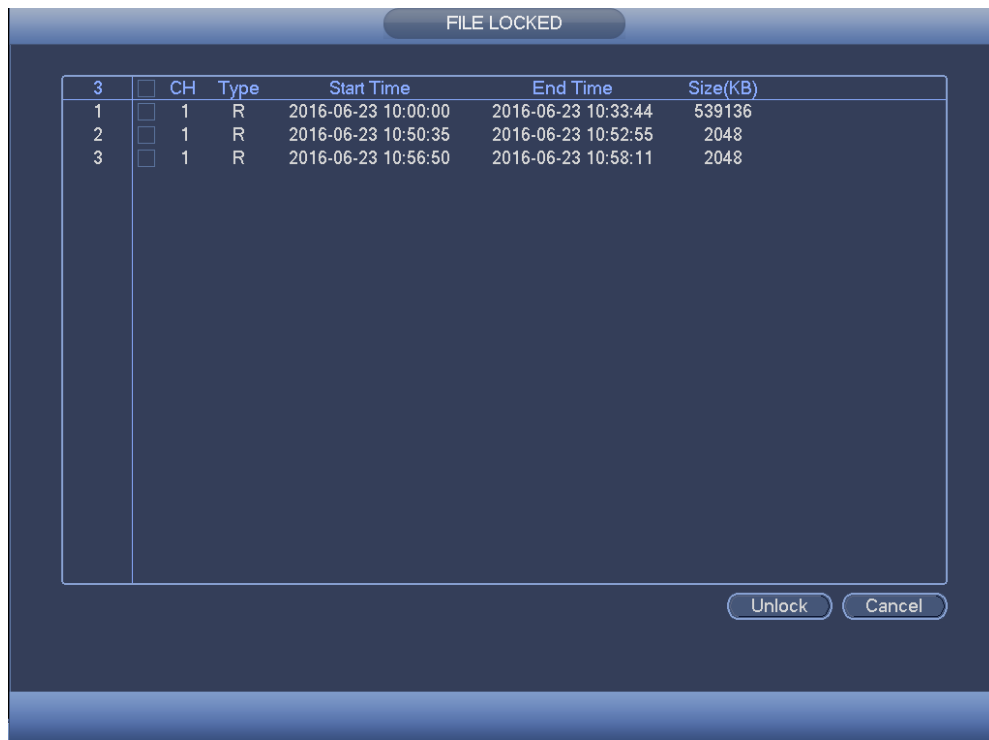

Figure 4-113

Select a file in the above figure and then click Unlock, you can unlock it.

## 4.6.9 Other Aux Functions

### 4.6.9.1 Digital Zoom

In 1-window playback mode, left click mouse to select any zone on the screen, you can zoom in current zone. Right click mouse to exit.

### 4.6.9.2 Switch Channel

During playback mode, select from the dropdown list to switch playback channel. This function is not for the channel of no record. The smart search channel does not support this function either.

## 4.7 Event Manager

### 4.7.1 Video Detect

The video detect adopts the computer image and graphics process technology. It can analyze the video and check there is considerable changing degree or not. Once video has changed considerably (such as there is any moving object, video is distorted), system can trigger the corresponding alarm activation operations.





In the main menu, from Setting to Detect, you can see motion detect interface. See Figure 4-118. There are four detection types: motion detection, video loss, tampering and scene changing.

### 4.7.1.1 Motion Detect

After analysis video, system can generate a motion detect alarm when the detected moving signal reached the sensitivity you set here.

Detection menu is shown as below. See Figure 4-118.

- Event type: From the dropdown list you can select motion detection type.
- Channel: Select a channel from the dropdown list to set motion detect function.
- Enable: Check the box here to enable motion detect function.
- Region: Click select button, the interface is shown as in Figure 4-119. Here you can set motion detection zone. There are four zones for you to set. Please select a zone first and then left drag the mouse to select a zone. The corresponding color zone displays different detection zone. You can click Fn button to switch between the arm mode and disarm mode. In arm mode, you can click the direction buttons to move the green rectangle to set the motion detection zone. After you completed the setup, please click ENTER button to exit current setup. Do remember click save button to save current setup. If you click ESC button to exit the region setup interface system will not save your zone setup.
- Anti-dither: Here you can set anti-dither time. The value ranges from 5 to 600s. The anti-dither time refers to the alarm signal lasts time. It can be seen as the alarm signal activation stays such as the buzzer, tour, PTZ activation, snapshot, channel record. The stay time here does not include the latch time. During the alarm process, the alarm signal can begin an anti-dither time if system detects the local alarm again. The screen prompt, alarm upload, email and etc will not be activated. For example, if you set the anti-dither time as 10 second, you can see the each activation may last 10s if the local alarm is activated. During the process, if system detects another local alarm signal at the fifth second, the buzzer, tour, PTZ activation, snapshot, record channel will begin another 10s while the screen prompt, alarm upload, email will not be activated again. After 10s, if system detects another alarm signal, it can generate an alarm since the anti-dither time is out.
- Period: Click set button, you can see an interface is shown as in Figure 4-121. Here you can set motion detect period. System only enables motion detect operation in the specified periods. It is not for video loss or the tampering. There are two ways for you to set periods. Please note system only supports 6 periods in one day.
  - ✧ In Figure 4-121, Select icon  of several dates, all checked items can be edited together. Now the icon is shown as . Click  to delete a record type from one period.
  - ✧ In Figure 4-121. Click button  after one date or a holiday, you can see an interface shown as in Figure 4-122. There are four record types: regular, motion detection (MD), Alarm, MD & alarm.
    - Alarm output: when an alarm occurs, system enables peripheral alarm devices.
    - Latch: when motion detection complete, system auto delays detecting for a specified time. The value ranges from 1-300(Unit: second)
    - Show message: System can pop up a message to alarm you in the local host screen if you enabled this function.

- Alarm upload: System can upload the alarm signal to the network (including alarm center) if you enabled current function.
- Send email: System can send out email to alert you when an alarm occurs.
- Record channel: System auto activates motion detection channel(s) to record once an alarm occurs. Please make sure you have set MD record in Schedule interface(Main Menu>Setting>Schedule) and schedule record in manual record interface(Main Menu>Advanced>Manual Record)
- PTZ activation: Here you can set PTZ movement when an alarm occurs. Such as go to preset, tour & pattern when there is an alarm. Click “select” button, you can see an interface is shown as in Figure 4-120.
- Record Delay: System can delay the record for specified time after alarm ended. The value ranges from 10s to 300s.
- Tour: Here you can enable tour function when alarm occurs. System one-window tour.
- Snapshot: You can enable this function to snapshot image when a motion detect alarm occurs.
- Video matrix Check the box here to enable this function. When an alarm occurs, SPOT OUT port displays device video output. It displays video (1-window tour) from alarm activation channel you select at the Record channel item.
- Buzzer: Highlight the icon to enable this function. The buzzer beeps when alarm occurs.

Please highlight icon  to select the corresponding function. After all the setups please click save button, system goes back to the previous menu.

**Note:**

In motion detection mode, you cannot use copy/paste to set channel setup since the video in each channel may not be the same.

In Figure 4-119, you can left click mouse and then drag it to set a region for motion detection. Click Fn to switch between arm/withdraw motion detection. After setting, click enter button to exit.



Figure 4-114

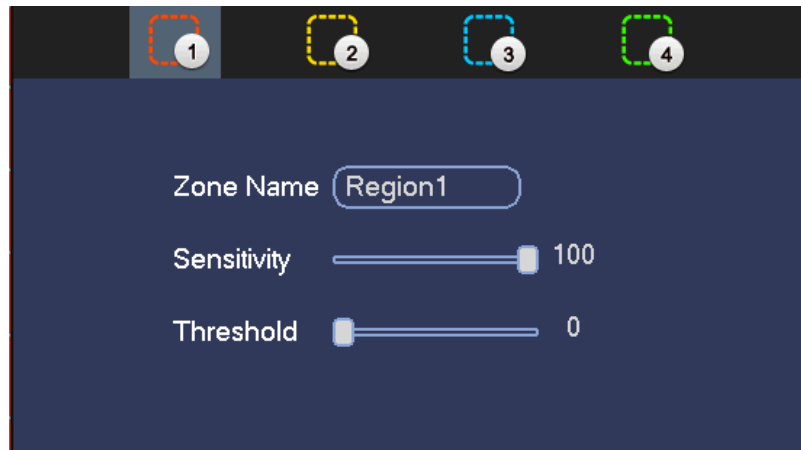

Figure 4-115

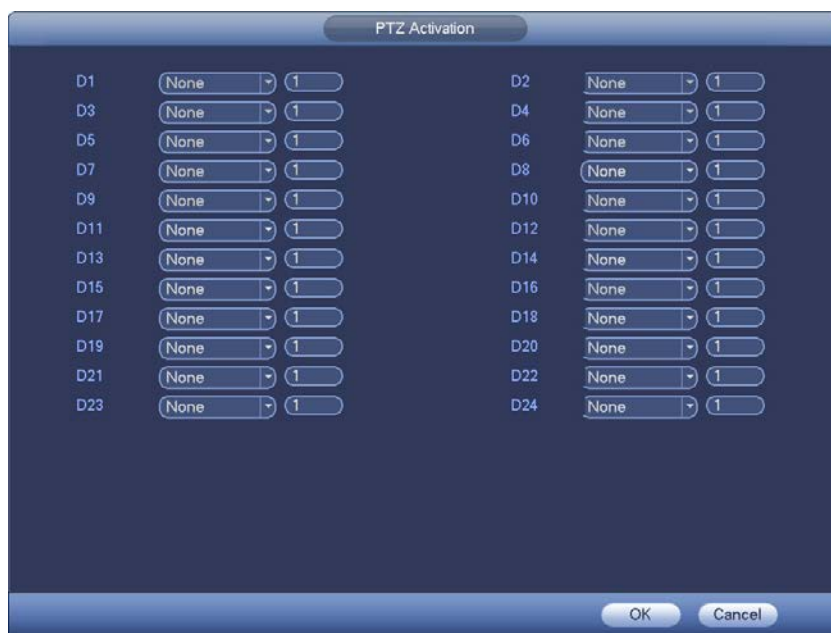

Figure 4-116

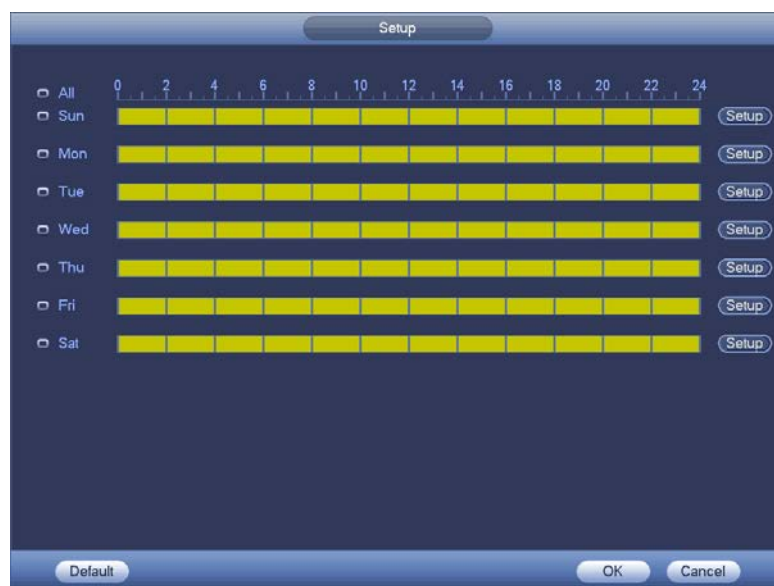

Figure 4-117



Figure 4-118

Motion detect here only has relationship with the sensitivity and region setup. It has no relationship with other setups.

### 4.7.1.2 Tampering

When someone viciously masks the lens, or the output video is in one-color due to the environments light change, the system can alert you to guarantee video continuity. Tampering interface is shown as in Figure 4-123. You can enable “Alarm output “or “Show message” function when tampering alarm occurs.

- Sensitivity: The value ranges from 1 to 6. It mainly concerns the brightness. The level 6 has the higher sensitivity than level 1. The default setup is 3.

#### Tips:

You can enable preset/tour/pattern activation operation when video loss occurs.

Please refer to chapter 4.7.1.1 motion detection for detailed information.



#### Note

- In Detect interface, copy/paste function is only valid for the same type, which means you cannot copy a channel setup in video loss mode to tampering mode.
- About Default function. Since detection channel and detection type may not be the same, system can only restore default setup of current detect type. For example, if you click Default button at the tampering interface, you can only restore default tampering setup. It is null for other detect types.
- System only enables tampering function during the period you set here. It is null for motion detect or video loss type.



Figure 4-119

### 4.7.1.3 Video Loss

After connected the system to the remote device, system can generate an alarm once the remote device has lost the video. System can trigger the corresponding alarm operations.

In Figure 4-118, select video loss from the type list. You can see the interface is shown as in Figure 4-124. This function allows you to be informed when video loss phenomenon occurred. You can enable alarm output channel and then enable show message function.

You can refer to chapter 4.7.1.1 Motion detect for detailed information.

**Tips:**

You can enable preset/tour/pattern activation operation when video loss occurs.



Figure 4-120

#### 4.7.1.4 Scene Changing

When the detected scene has changed, system can generate an alarm.

From main menu>Setting>Event>Video detect>Scene change, the interface is shown as in Figure 4-125.

Please refer to chapter 4.7.1.1Motion detect for detailed information.





Figure 4-121

## 4.7.2 Smart Plan

The smart plan is for the smart network camera. If you do not set a rule here, you cannot use the intelligent functions in IVS (Chapter 4.7.3), Face detection (Chapter 4.7.4) and People counting (Chapter 4.7.7) when you are connecting to a smart network camera.

There are two types to realize intelligent analytics function.

### NOTE

- Smart network camera supports intelligent functions: Some smart camera supports the intelligent functions. For NVR, it just displays the intelligent alarm information from the smart network camera and set or playback the record file.
- NVR supports intelligent functions: The connected network camera does not support intelligent video analytics function. The NVR supports the analytics function.

In this interface, you can quickly add an intelligent rule for one preset. The intelligent rule includes human face detection, IVS and people counting.

From main menu>Setting>Event>Smart plan, the interface is shown as below. See Figure 4-126.



Figure 4-122

Please select a channel number and a preset. Click Add.

The preset is now on the list. See Figure 4-127.

 NOTE

Some smart camera does not need to add the preset. Please refer to the actual product for detailed information.



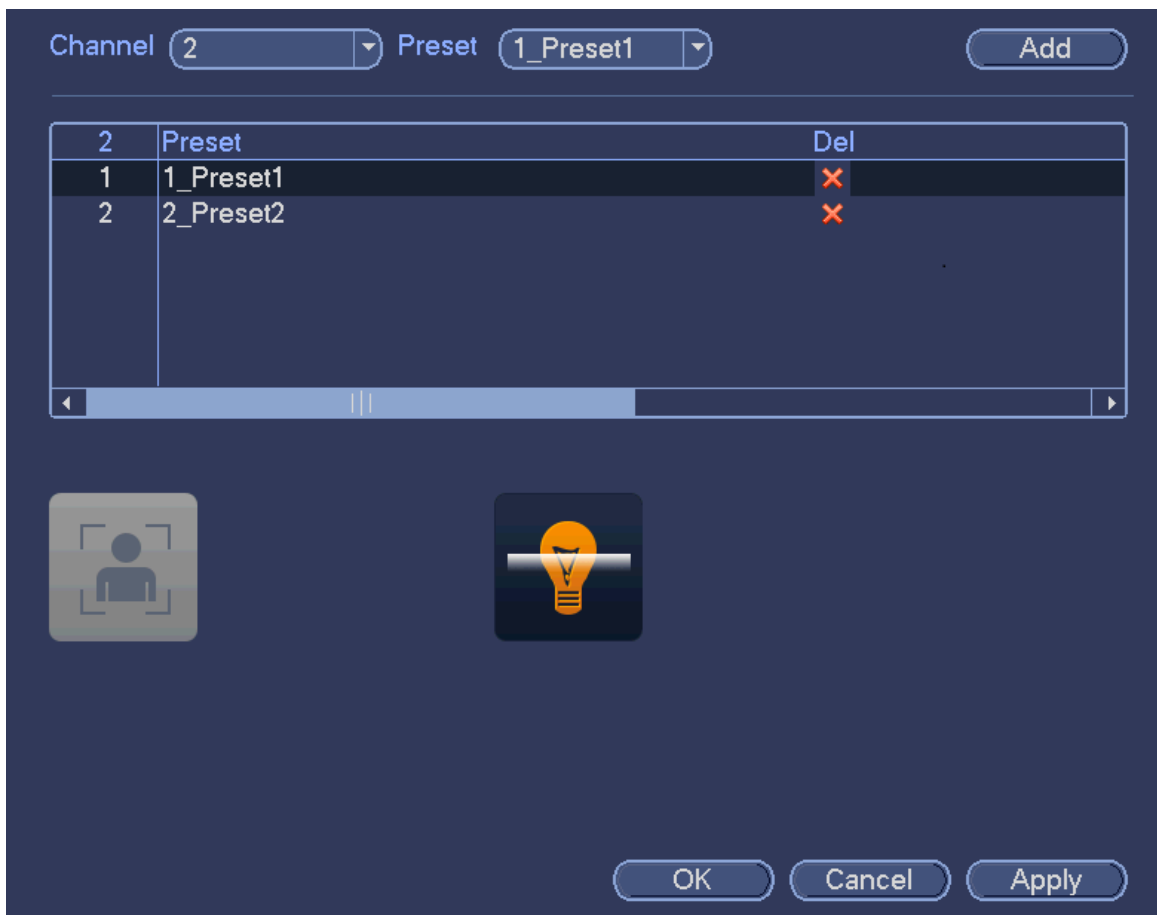

Figure 4-123

Select a smart plant from the dropdown list and then click the corresponding intelligent plan icon. See Figure 4-127.

NOTE

- The NVR supports IVS, human face detection, heat map, and people counting. Different network camera supports different smart plans. Please refer to the actual product for detailed information.
- The IVS and human face detection function cannot be valid at the same time. For example, when add the IVS plan to the preset 1, the human face detection icon becomes grey.

Click OK to complete the setup.

### 4.7.3 IVS

IVS refers to extracting the key information in the video through image processing and analysis, and matching with the preset detection rules. When the detected behavior matches the detection rule, the system performs the alarm linkage action.

NOTE

**Only some devices support this function. See the actual situation.**

System supports AI by camera and AI by device. When both functions are enabled at the same time, AI by device is preferred.

- IVS of AI by camera includes tripwire, intrusion, abandoned object, fast moving, missing object and global setup.

 NOTE

IVS of AI by camera and face detection function are mutually exclusive.

- IVS of AI by device includes tripwire and intrusion.

The scenario requirements of IVS are listed as follows:

- The total target ratio does not exceed 10% of the screen.
- The size of the target in the picture is not less than 10 pixels × 10 pixels, the target size of the abandoned object is not less than 15 pixels × 15 pixels (CIF image); the target height and width is not more than 1/3 of the picture height and the recommended target height is 10% of the picture height.
- The difference between the brightness value of the target and the background is not less than 10 gray levels.
- At least ensure that the target appears continuously for more than 2 seconds in the field of view, the moving distance exceeds the target's own width, and is not less than 15 pixels (CIF image).
- Minimize the complexity of the monitoring and analysis scenario when conditions permit. It is not recommended to use the smart analysis function in scenarios with dense targets and frequent light changes.
- Try to avoid areas such as glass, ground reflection and water surface; try to avoid branches, shadows and mosquito interference areas; try to avoid backlit scenes and avoid direct light.

Step 1 Enter from main menu > Setting > Event > IVS.

The IVS interface is displayed. See Figure 4-128

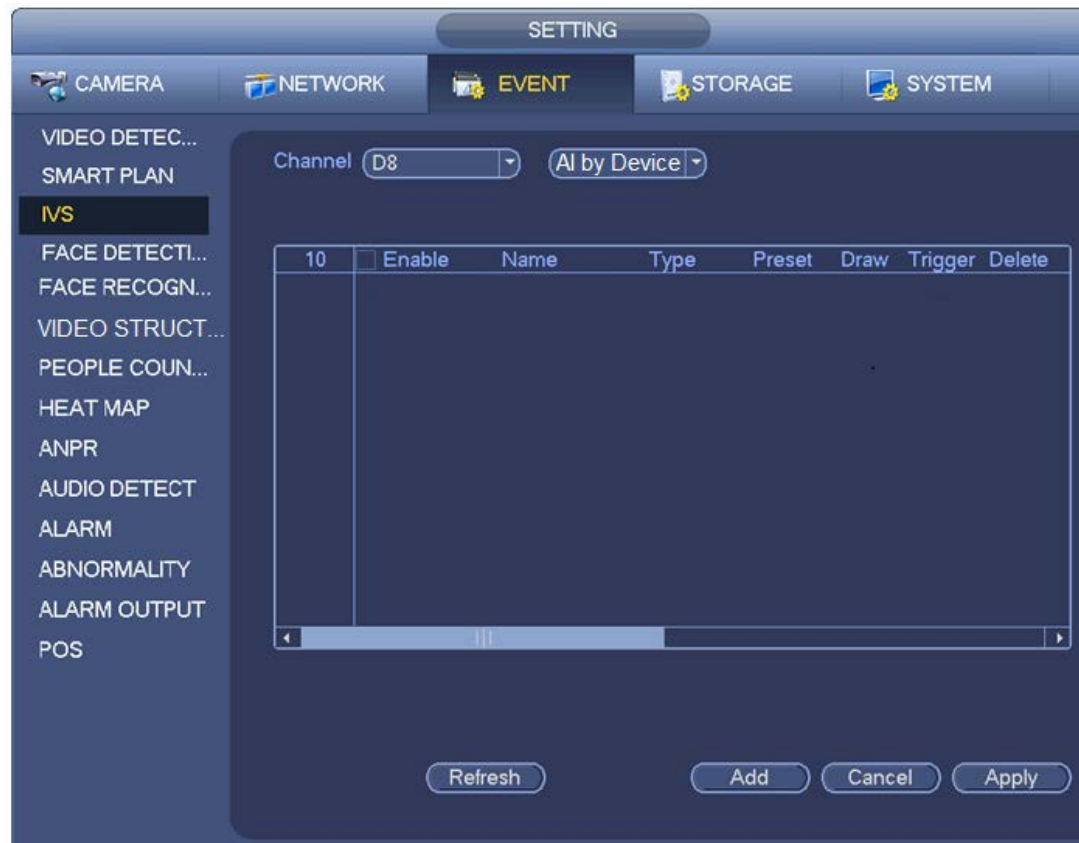

Figure 4-124

Step 2 Select the channel number to set IVS.

Step 3 Select the smart analysis type.

 NOTE

AI by camera needs to connect to intelligent IPC on the front end. Different intelligent IPCs support different functions.

Step 4 Click Add and select the rule type according to the actual needs. See Figure 4-129.

 NOTE

Click  to delete the corresponding rule.

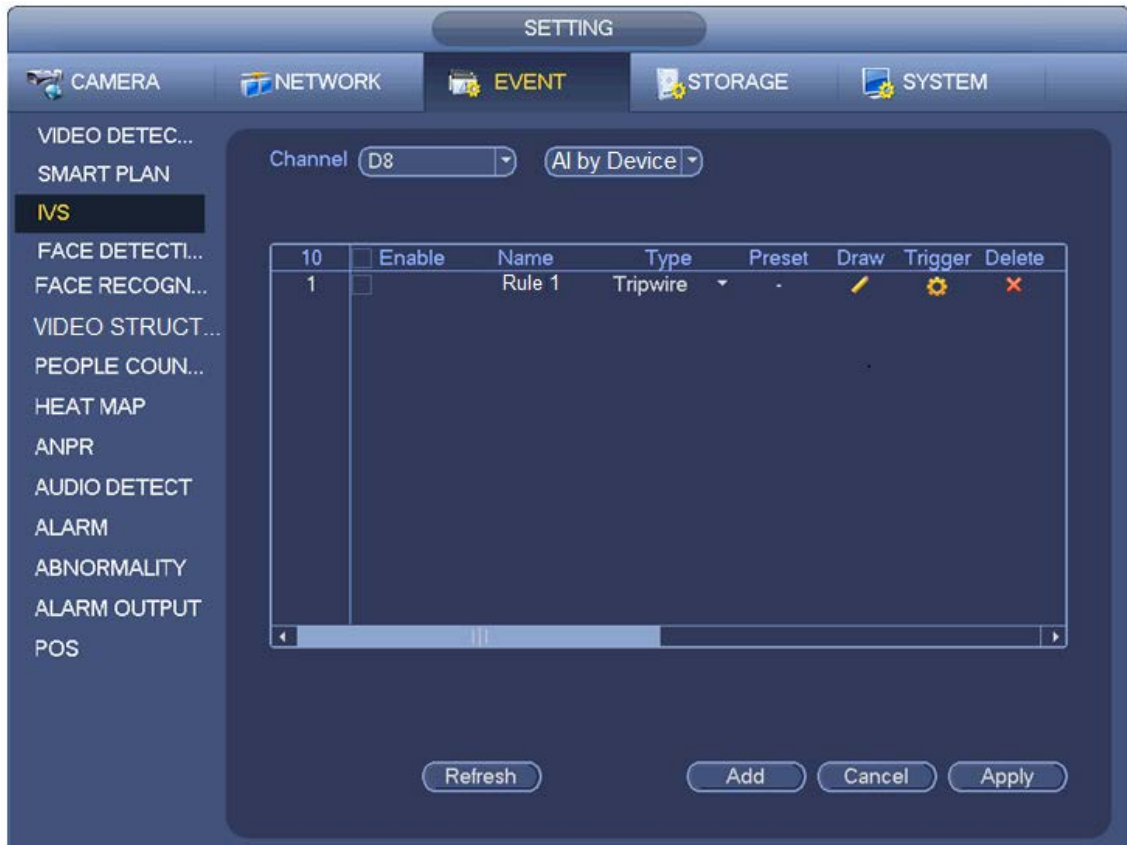

Figure 4-125

Step 5 Configure the corresponding parameters according to the rule type.

Step 6 Click OK to complete the IVS setting.

### 4.7.3.1 Tripwire

When the detection target crosses the warning line along the set direction, the system performs an alarm linkage action.

Step 1 In the Type drop-down list, select Tripwire. See Figure 4-130.

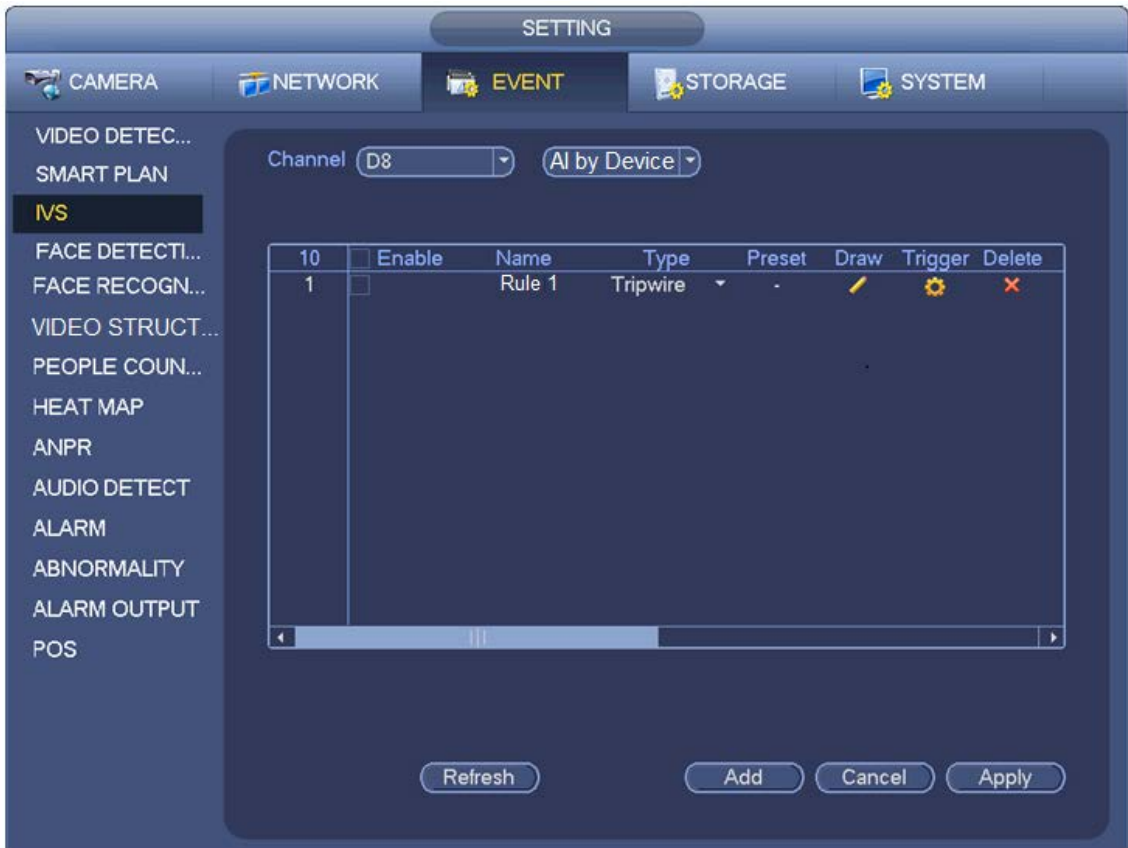

Figure 4-126

Step 2 Click to draw the detection rule.

- When you select AI by camera, the system displays as Figure 4-131.





Figure 4-127

- When you select AI by device, the system displays as Figure 4-132.



Figure 4-128

Step 3 Configure the parameters. For details, see the following table.

Parameter	Description
Name	Customize the rule name.
Direction	Set the tripwire direction, including A→B, B→A and A↔B.
Filter target	<p>Click  to filter the target. Check the blue wireframe and adjust the size of the area with the mouse.</p> <p> <b>NOTE</b>            Each rule can set 2 target filters (maximum size and minimum size), that is, when the passing target is smaller than the minimum target or larger than the maximum target, no alarm will be generated. The maximum size should not be smaller than the minimum size.</p>
AI Recognition	<p>Select AI recognition and the system displays alarm target. The default selection is person and motor vehicle and system automatically identifies the person and motor vehicle appeared within the monitoring range.</p> <p> <b>NOTE</b>            When you select IVS of AI by camera, the front-end device shall support perimeter protection function. For details, see "4.7.3.3 Perimeter Protection."</p>

Step 4 Press and hold down the left button on the monitor screen to draw the line. The line can be a straight line or a curve.



Step 5 Click OK to complete the rule setting.



Step 6 Click .





System displays the Trigger interface. See Figure 4-133



Figure 4-129

Step 7 Configure the parameters. For details, see the following table.

Parameter	Description
Period	Configure the period and in the set time range, the corresponding configuration item will be linked to start the alarm.
Alarm Out	The alarm device (such as lights, sirens, etc.) is connected to the alarm output port. When an alarm occurs, the NVR device transmits the alarm information to the alarm device.
Latch	When the alarm ends, the alarm extends for a period of time. The time range is from 0 seconds to 300 seconds.
Alarm Upload	Select the check box. When an alarm occurs, the NVR device uploads an alarm signal to the network (including the alarm center).  NOTE <ul style="list-style-type: none"> <li>Only some devices support this function. See the actual situation.</li> <li>You shall set the alarm center first. For details, see "4.8.1.9 Alarm Centre."</li> </ul>
Send Email	Select the check box. When an alarm occurs, the NVR device sends an email to the set mailbox to notify the user.  NOTE You shall set the email first. For details, see "4.8.1.6 Email."

Parameter	Description
Record Channel	Select the check box and select the needed recording channel (support multiple choices). When an alarm occurs, the NVR device activates the channel for recording.  NOTE You shall enable intelligent recording and auto recording first. For details, see "4.1.4.5 Schedule."
PTZ Activation	Select the check box and click Setting to select the channel and PTZ action. When an alarm occurs, the NVR device associates the channel to perform the corresponding PTZ action. For example, activate the PTZ in channel one to turn to the preset point X.  NOTE <ul style="list-style-type: none"> <li>• Tripwire alarm supports to activate PTZ preset point only.</li> <li>• You shall set the corresponding PTZ actions first.</li> </ul>
Delay	At the end of the alarm, the recording extends for a period of time. The time range is from 10 seconds to 300 seconds.
Tour	Select the check box and select the channel for tour. When an alarm occurs, the local interface of the NVR device displays the selected channel screen.  NOTE <ul style="list-style-type: none"> <li>• You shall set the time interval and mode for tour first.</li> <li>• After the tour is over, the preview interface is restored to the screen split mode before the tour.</li> </ul>
Snapshot	Select the check box and select the channel for snapshot. When an alarm occurs, the NVR device triggers the snapshot of the selected channel.  NOTE You shall enable the intelligent snapshot and auto snapshot first. For details, see "4.1.4.5 Schedule."
Log	Select the check box, the NVR device records the alarm information in the log when an alarm occurs.
Voice Prompts	Select the check box and select the corresponding voice file in the File Name drop-down box. When an alarm occurs, the system plays the voice file.  NOTE You shall add the corresponding voice file first. For detailss, see "4.10.3 Voice."
Buzzer	Select the check box to activate the buzzer when an alarm occurs.

Step 8 Click OK to save the alarm setting.

System displays the IVS interface.

Step 9 Select the Enable check box and click Apply to complete the tripwire setting.

### 4.7.3.2 Intrusion

When the detection target passes the edge of the monitoring area, and enters, leaves or traverses the monitoring area, the system performs an alarm linkage action.

Step 1 In the Type drop-down list, select Intrusion. See Figure 4-134.

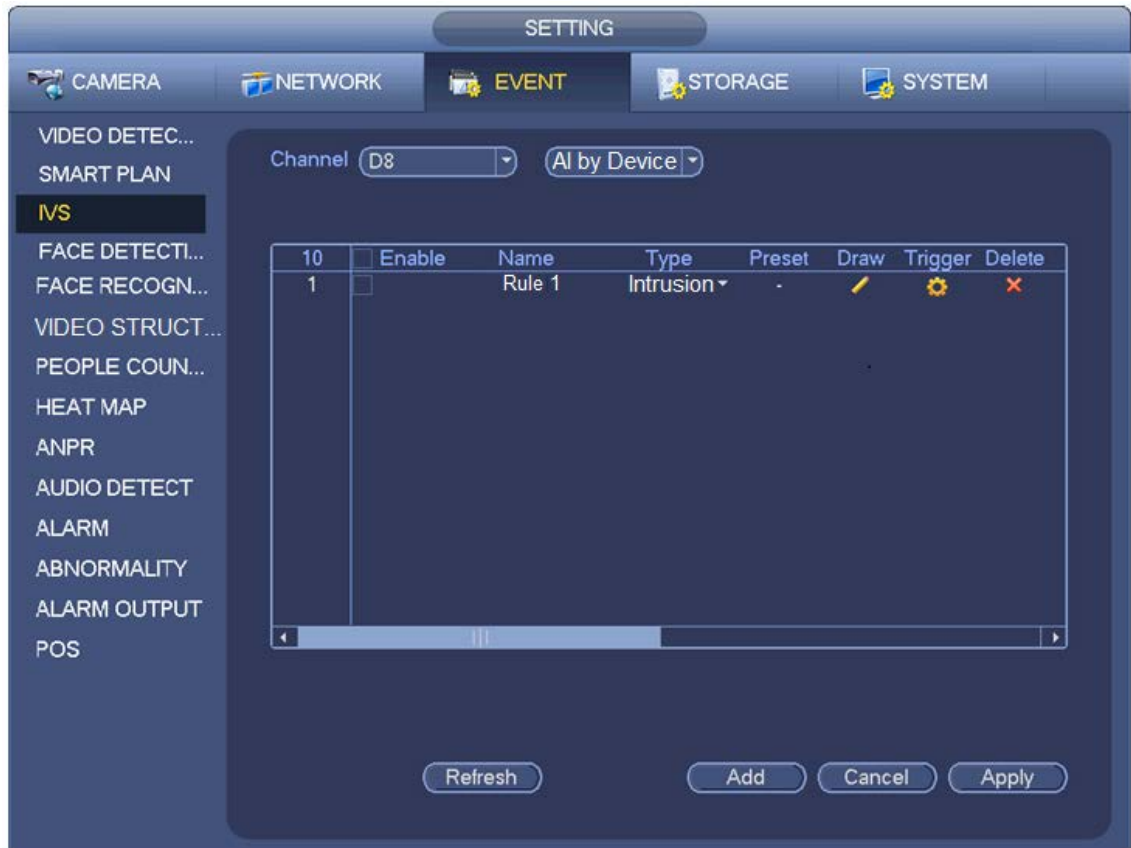

Figure 4-130

Step 2 Click to draw the detection rule.

- When you select AI by camera, the system displays as Figure 4-135.

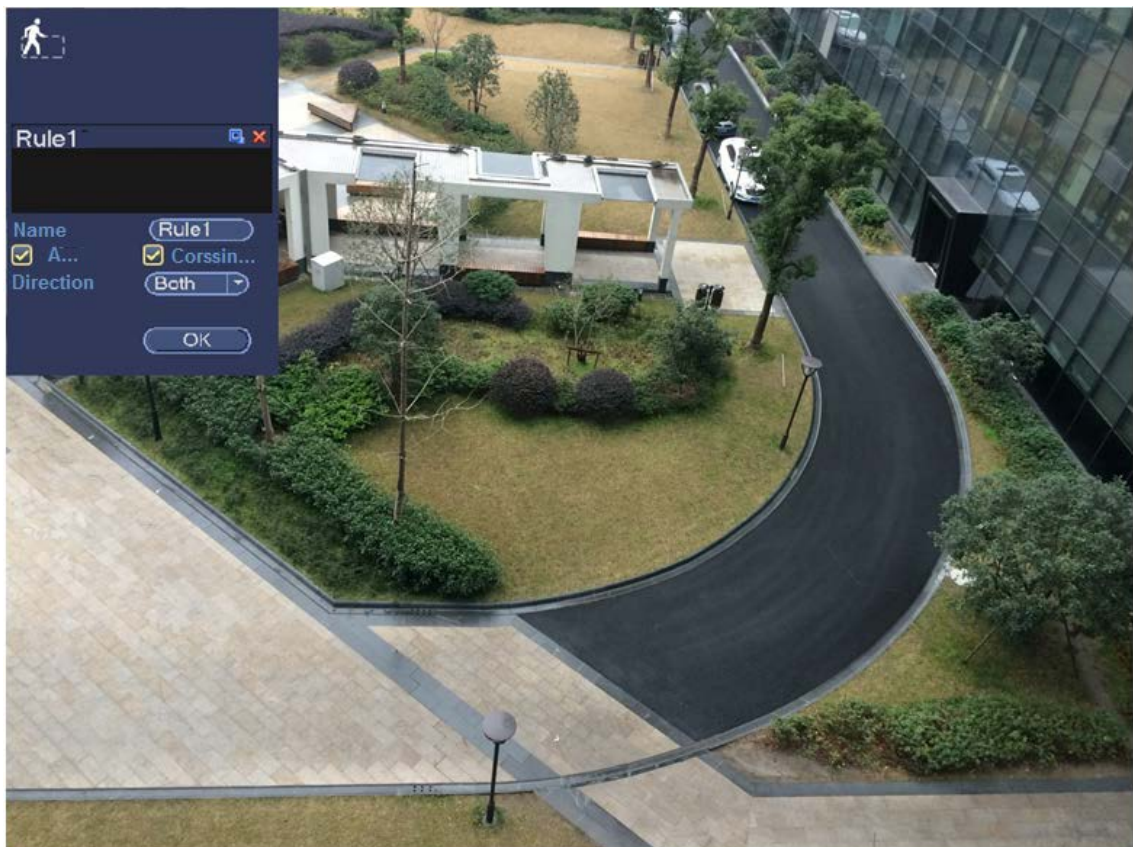







Figure 4-131

- When you select AI by device, the system displays as Figure 4-136.



Figure 4-132

Step 3 Configure the parameters. For details, see the following table.

Parameter	Description
Name	Customize the rule name.
Action	Set the intrusion action, including appear and crossing area.
Direction	Set the direction to cross the area, including enter, exit and both.
Filter target	<p>Click  to filter the target. Check the blue wireframe and adjust the size of the area with the mouse.</p> <p> NOTE Each rule can set 2 target filters (maximum size and minimum size), that is, when the passing target is smaller than the minimum target or larger than the maximum target, no alarm will be generated. The maximum size should not be smaller than the minimum size.</p>
AI recognition	<p>Select AI recognition and the system displays alarm target. The default selection is person and motor vehicle and system automatically identifies the person and motor vehicle appeared within the monitoring range.</p> <p> NOTE When you select IVS of AI by camera, the front-end device shall support perimeter protection function. For details, see "4.7.3.3 Perimeter Protection."</p>

Step 4 Press and hold down the left button on the monitoring screen to draw the monitoring area.

Step 5 Click OK to complete the rule setting.

Step 6 Click  to configure and save the parameters.

Step 7 Select the Enable check box and click Apply to complete the intrusion setting.

### 4.7.3.3 Perimeter Protection

The system supports perimeter protection detection for people and vehicles. When the detected behavior matches with the detection rule, system performs the linked alarm action.

Perimeter protection includes two functions: Tripwire and intrusion.

Step 1 Enter from main menu > Setting > Event > IVS.

The IVS interface is displayed. See Figure 4-137.

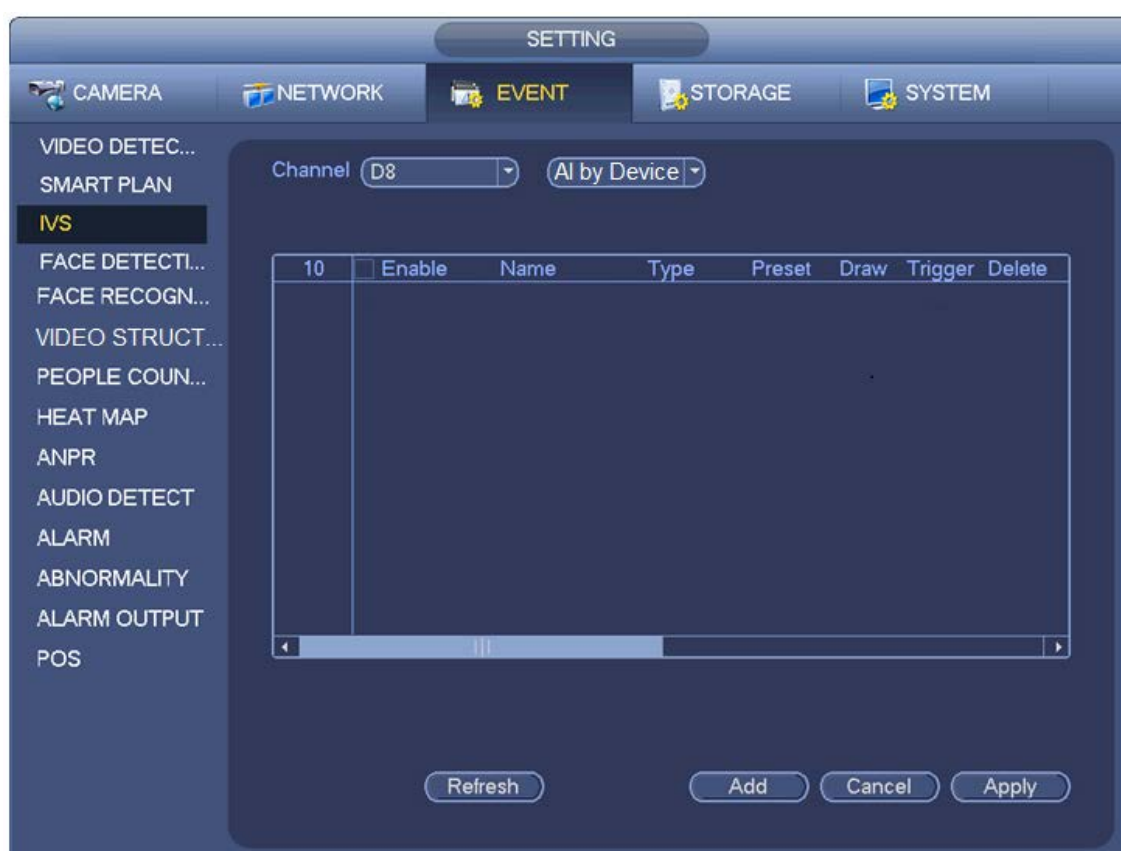

Figure 4-133

Step 14 Select the channel. Select AI by camera or AI by device.

 NOTE

If you select AI by camera, the front-end camera shall support perimeter protection.

Step 15 Click Add and select tripwire or intrusion in the Type drop-down list.

Step 16 Configure the detection rule and linked parameters. For details, see "4.7.3.1 Tripwire" and "4.7.3.2 Intrusion."

Step 17 Configure the relevant parameters according to the rule type.

Step 18 Click OK to complete the perimeter protection setting.

### 4.7.3.4 Abandoned Object

System generates an alarm when there is abandoned object in the specified zone.

From main menu > Setting > Event > IVS, select the type as abandoned object and the interface is shown as Figure 4-138.

- System supports customized area shape and amount.
- Support duration setup.
- Support objects filter function.

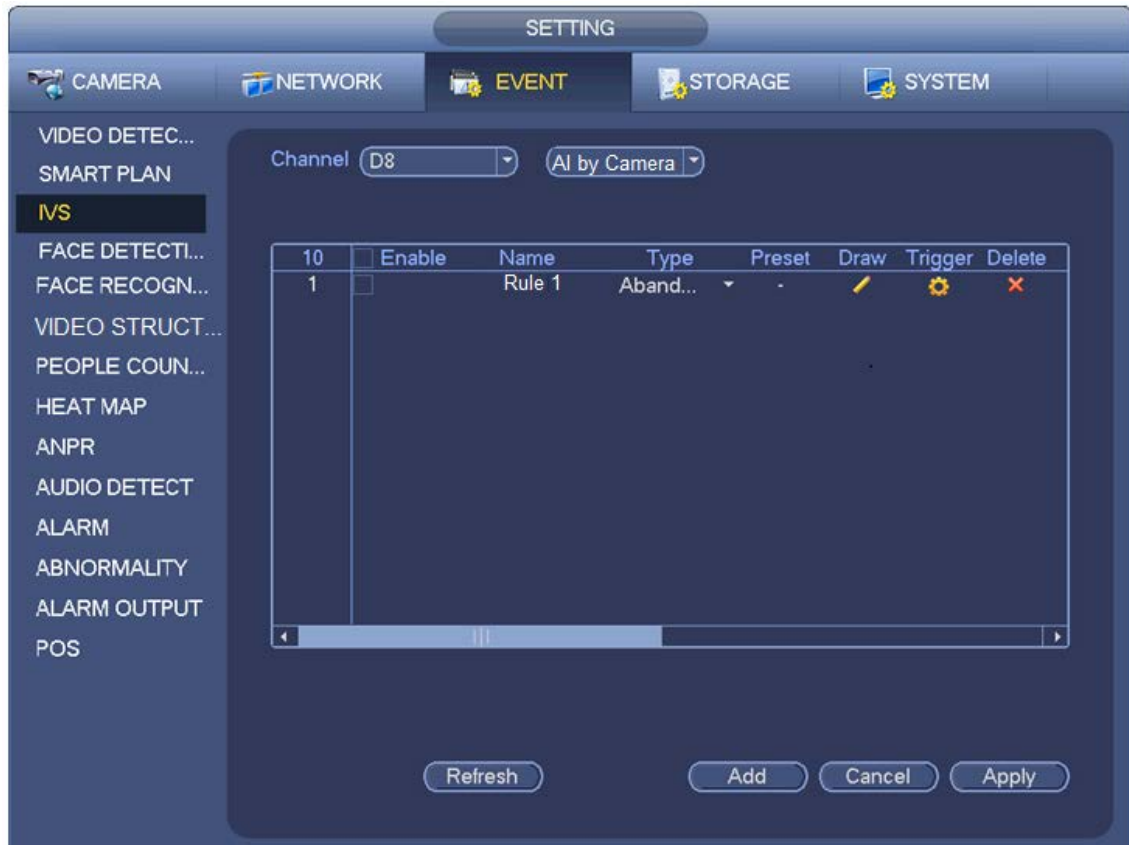



Figure 4-134

Click draw button  to draw the zone. See Figure 4-139.

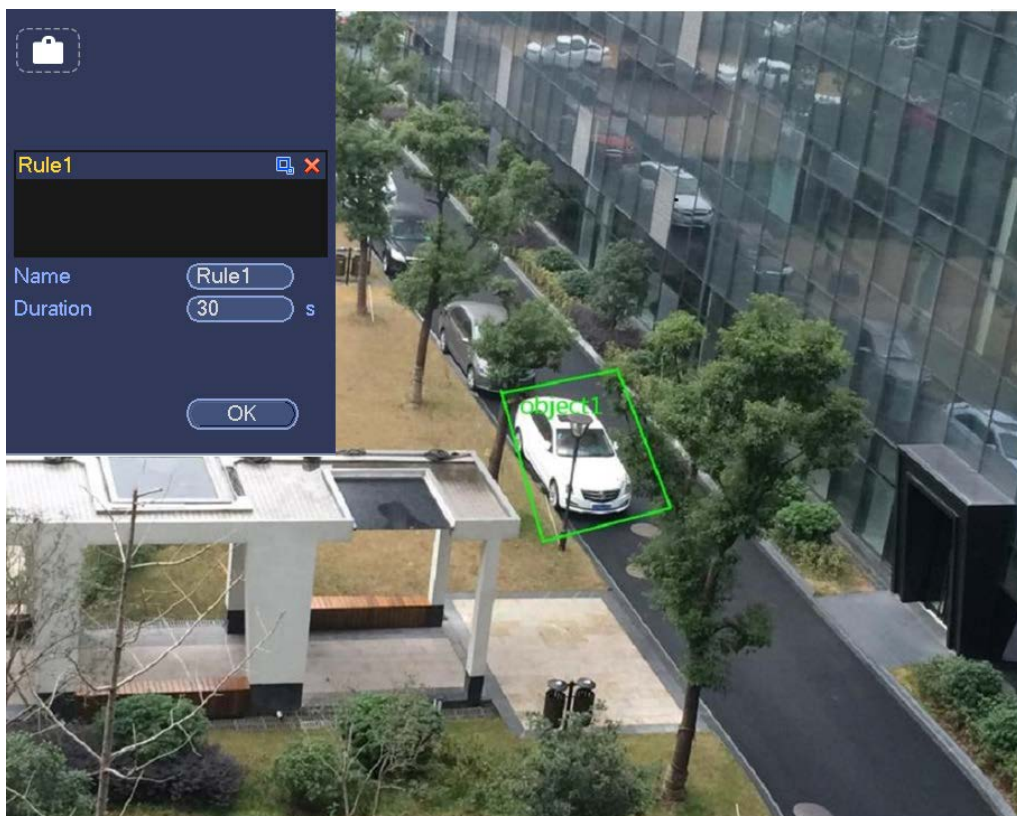



Figure 4-135

- Preset: Select a preset you want to use IVS.
- Name: Input customized rule name.
- Duration: System can generate an alarm once the object is in the zone for the specified period.
- Target filter: Click , you can set filter object size. Each rule can set two sizes (min size/max size). Once the object is smaller than the min size or larger than the max size, there is no alarm. Please make sure the max size is larger than the min size.

Now you can draw a rule. Left click mouse to draw a zone, until you draw a rectangle, you can right click mouse.

#### Tips

Click  to delete the corresponding rule.

Click , you can refer to the chapter 4.7.3.1 to set other parameters.

Click Apply to complete the setup.

### 4.7.3.5 Fast moving

It is to detect the fast moving object in the specified zone.

From main menu > Setting > Event > IVS, select the type as fast moving, the interface is shown as below. See Figure 4-140.

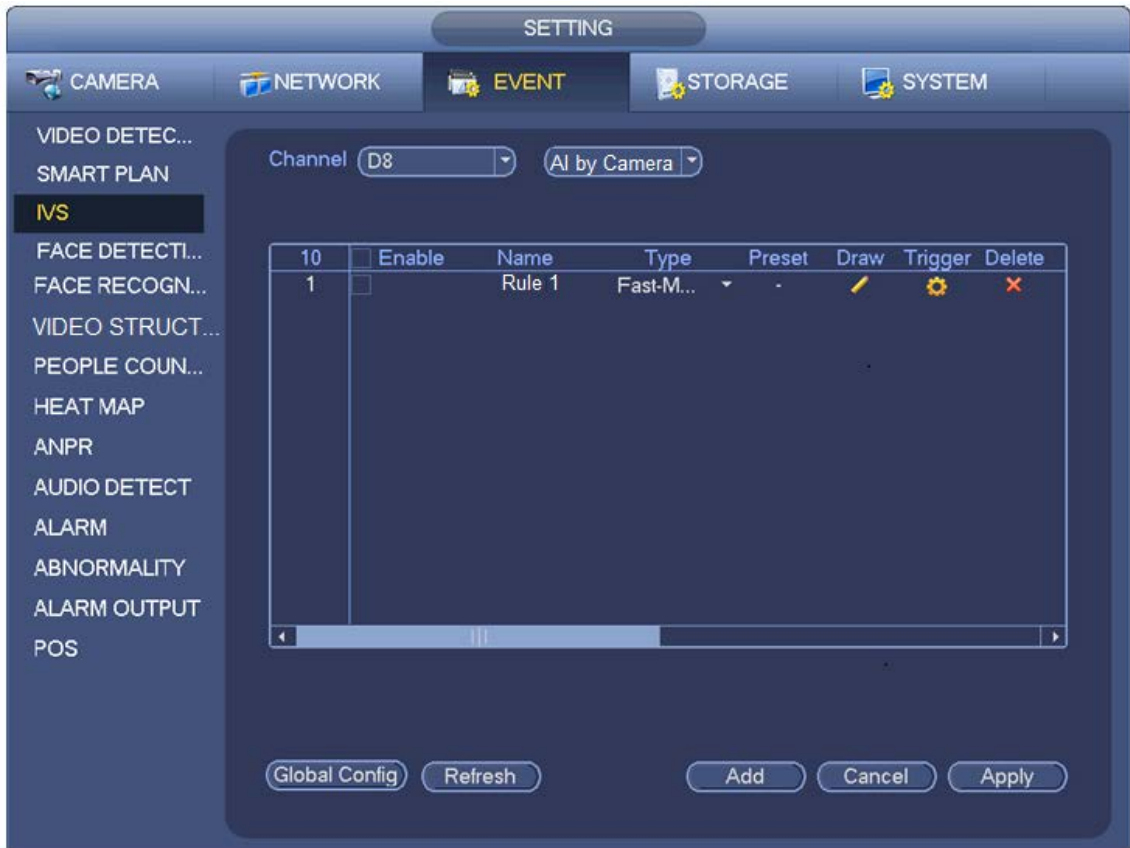



Figure 4-136

Click draw button  to draw the zone. See Figure 4-141.



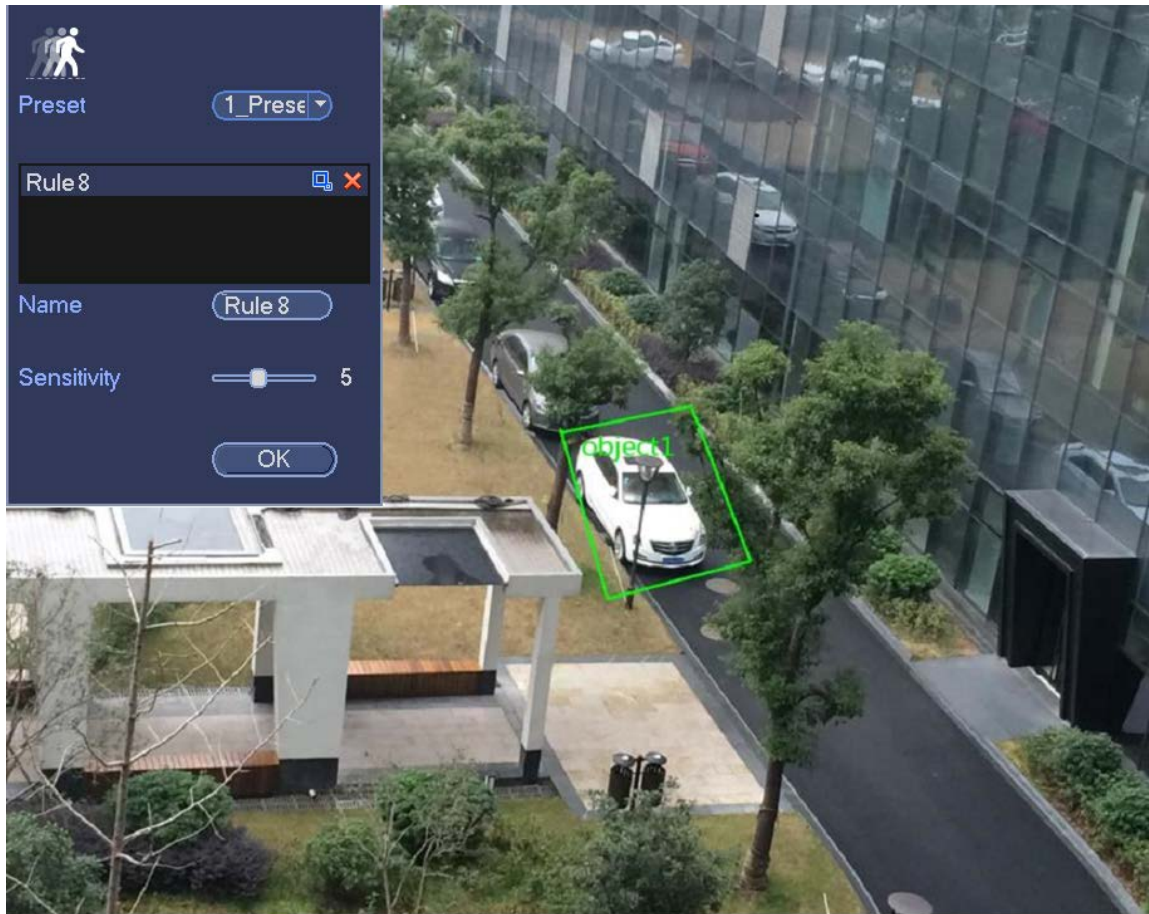



Figure 4-137

- Preset: Select a preset you want to use IVS.
- Name: Input customized rule name.
- Sensitivity: It is to set alarm sensitivity. The value ranges from 1 to 10. The default setup is 5.
- Target filter: Click , you can set filter object size. Each rule can set two sizes (min size/max size).  
Once the object is smaller than the min size or larger than the max size, there is no alarm. Please make sure the max size is larger than the min size.

Now you can draw a rule. Left click mouse to draw a zone, until you draw a rectangle, you can right click mouse.

### Tips

Click  to delete the corresponding rule.

Click , you can refer to the chapter 4.7.3.1 to set other parameters.

Click Apply to complete the setup.

## 4.7.3.6 Crowd Gathering

System can generate an alarm once the people amount gathering in the specified zone is larger than the threshold.

From main menu->Setting->Event->Behavior analytics, select the type as crowd gathering detect, the interface is shown as below. See Figure 4-142.

- Customized zone and amount setup.
- Duration setup.
- Sensitivity setup.
- Min gathering zone setup.

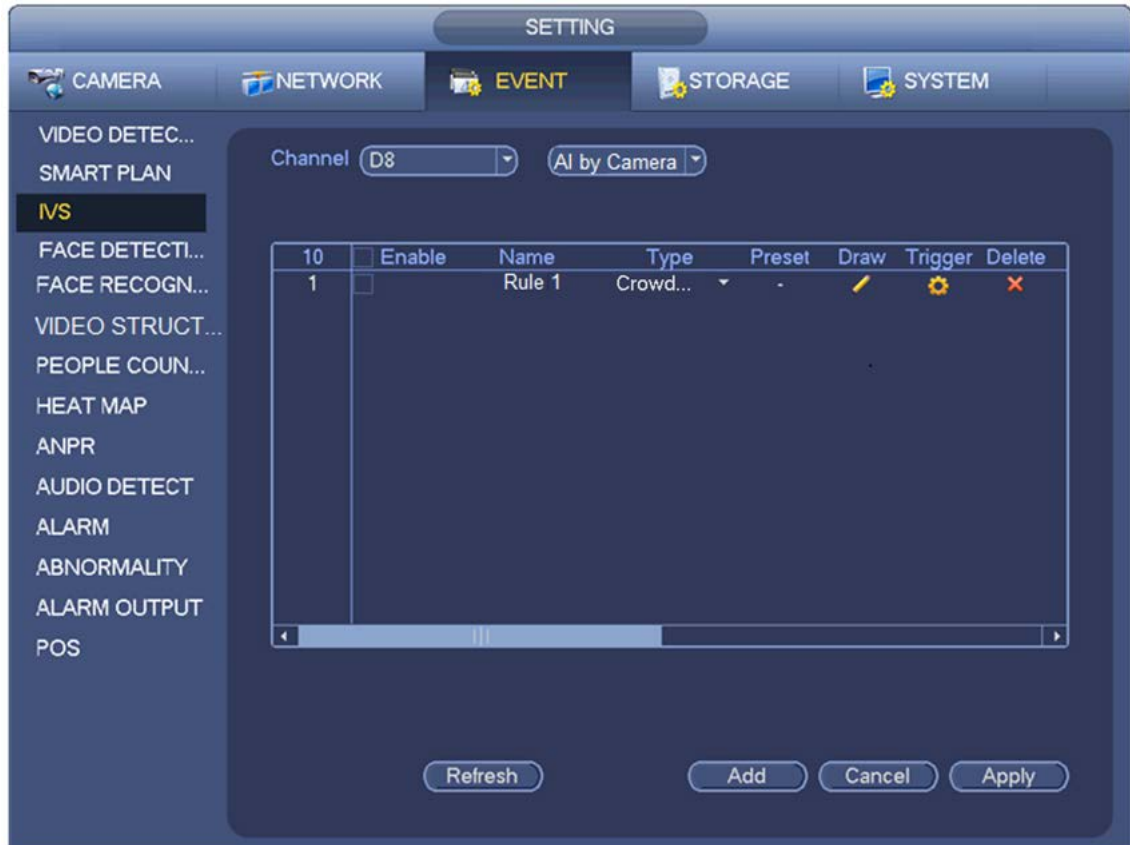



Figure 4-138

Click draw button  to draw the zone. See Figure 4-143.

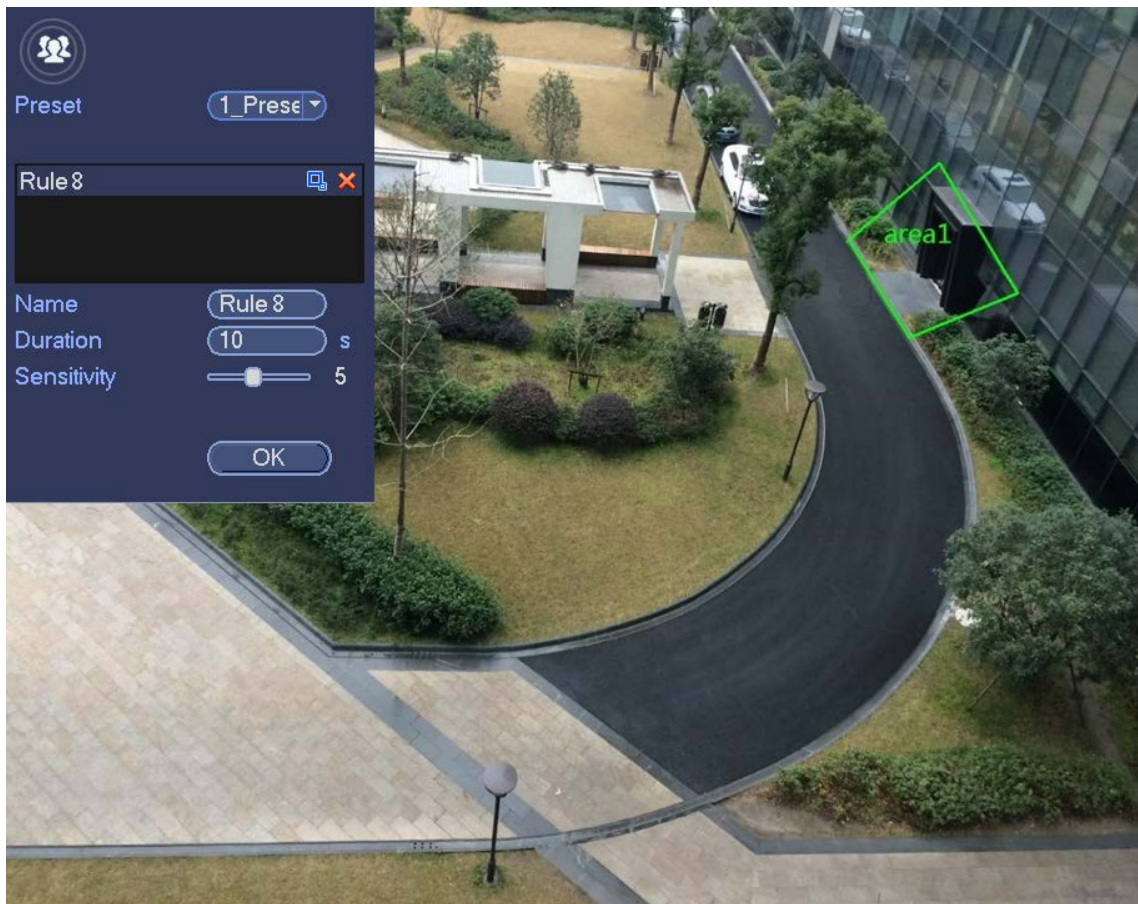



Figure 4-139

- Preset: Select a preset you want to use behavior analytics.
- Name: Input customized rule name.
- Duration: System can generate an alarm once the object is in the zone for the specified period.
- Sensitivity: It is to set alarm sensitivity. The value ranges from 1 to 10. The default setup is 5.
- Target filter: Click , you can set filter object size. Each rule can set two sizes (min size/max size). Once the object is smaller than the min size or larger than the max size, there is no alarm. Please make sure the max size is larger than the min size.

Now you can draw a rule. Left click mouse to draw a zone, until you draw a rectangle, you can right click mouse.

#### Tips

Click  to delete the corresponding rule.

Click , you can refer to the chapter 4.7.3.1 to set other parameters.

Click Apply to complete the setup.

### 4.7.3.7 Parking

When the detection target stays in the monitoring area for more than the set duration, the system performs alarm linkage action.

Step 1 In the Type drop-down list, select Parking. See Figure 4-144.



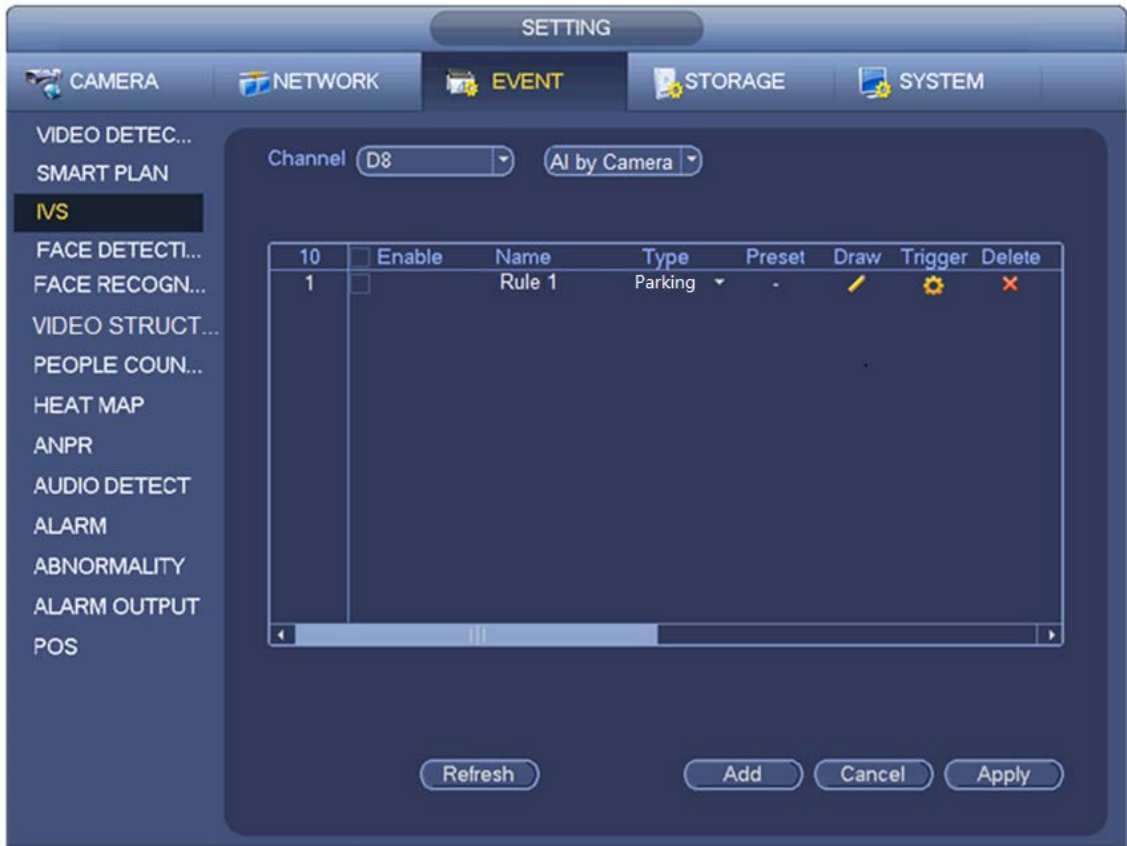



Figure 4-140

Step 2 Draw the detection rule.

1. Click  to draw the rule in the monitoring screen. See Figure 4-145.

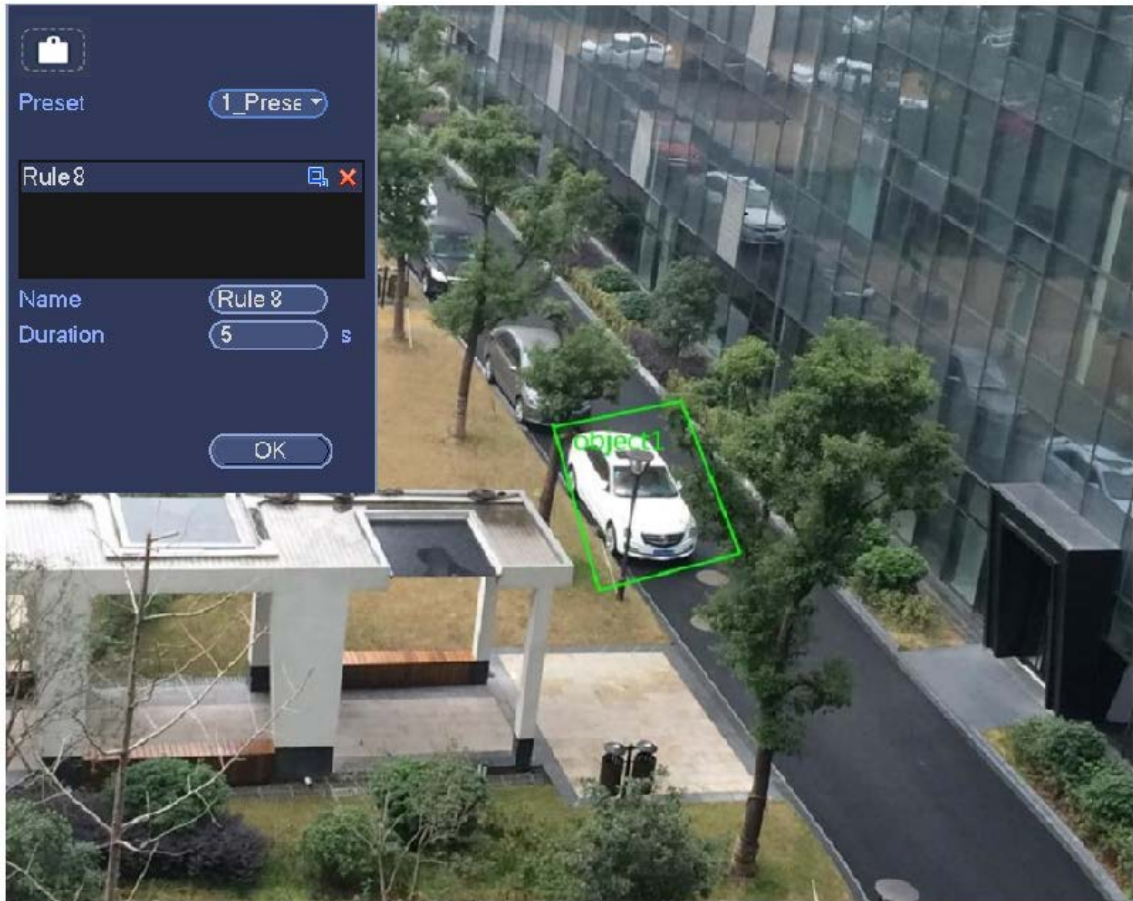



Figure 4-141

2. Configure the parameters. For details, see the following table.

Parameter	Description
Preset	Set the preset point for IVS detection according to the actual needs.
Name	Customize the rule name.
Duration	Set the minimum time that the object stays until the alarm is triggered.
Filter target	<p>Click  to filter the target. Check the blue wireframe and adjust the size of the area with the mouse.</p> <p> NOTE</p> <p>Each rule can set 2 target filters (maximum size and minimum size), that is, when the passing target is smaller than the minimum target or larger than the maximum target, no alarm will be generated. The maximum size should not be smaller than the minimum size.</p>

3. Press and hold down the left button on the monitor screen to draw the monitoring area.
4. Click OK to complete the setting.

Step 3 Click  to configure the parameters. For details, see chapter 4.7.3.1.

Step 4 Select the Enable check box and click Apply to complete the setting.

### 4.7.3.8 Missing Object Detection

System generates an alarm when there is missing object in the specified zone.

From main menu > Setting > Event > IVS, select the type as abandoned object, the object interface is shown as below. See Figure 4-146.

- System supports customized area shape and amount.
- Support duration setup.
- Support objects filter function.

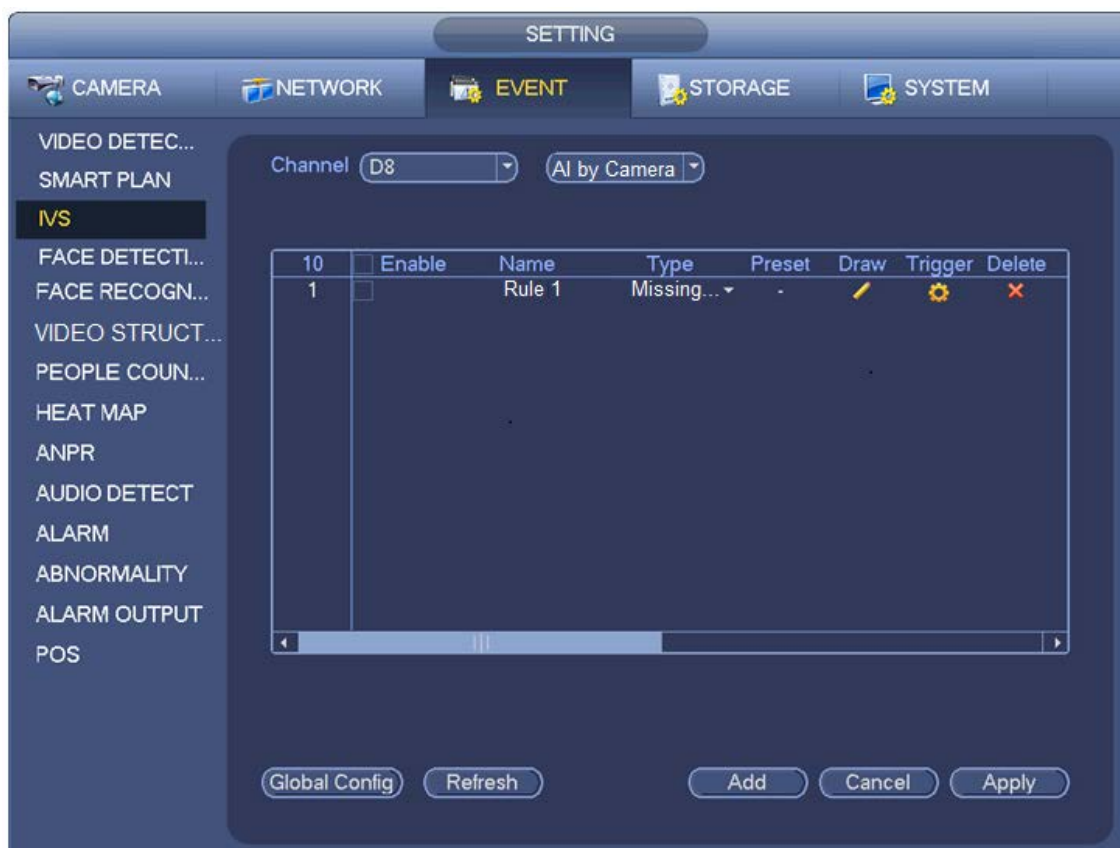



Figure 4-142

Click Draw button  to draw a zone. See Figure 4-147.

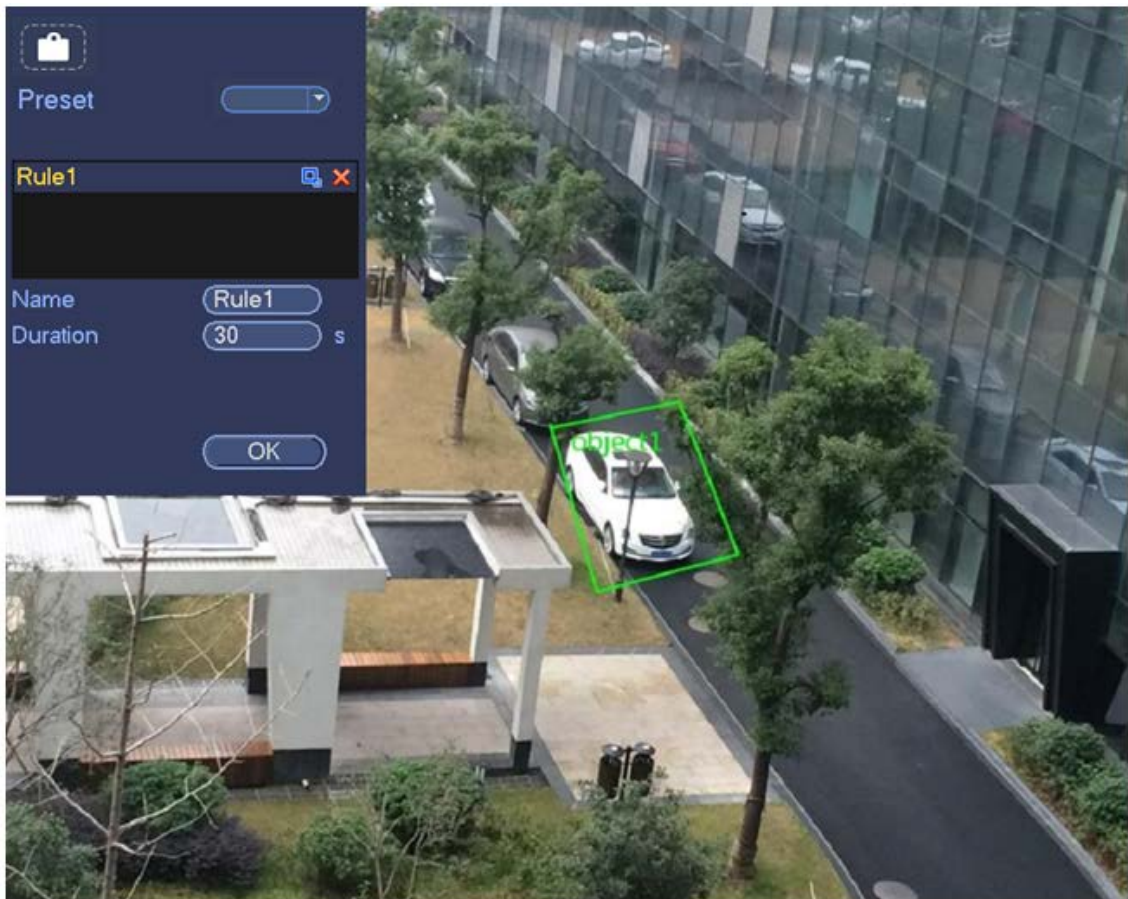



Figure 4-143

- Preset: Select a preset you want to use IVS.
- Name: Input customized rule name.
- Duration: System can generate an alarm once the object in the zone is missing for the specified period.
- Target filter: Click , you can set filter object size. Each rule can set two sizes (min size/max size). Once the object is smaller than the min size or larger than the max size, there is no alarm. Please make sure the max size is larger than the min size.

Now you can draw a rule. Left click mouse to draw a zone, until you draw a rectangle, you can right click mouse.

#### Tips

Click  to delete the corresponding rule.

Click  and you can refer to the chapter 4.7.3.1 to set other parameters.

Click Apply to complete the setup.

### 4.7.3.9 Loitering Detection

System can generate an alarm once the object is staying in the specified zone longer than the threshold. From main menu->Setting->Event->Behavior analytics, select the type as loitering, the object interface is shown as below. See Figure 4-148.

- System supports customized area shape and amount.
- Support duration setup.
- Support objects filter function.

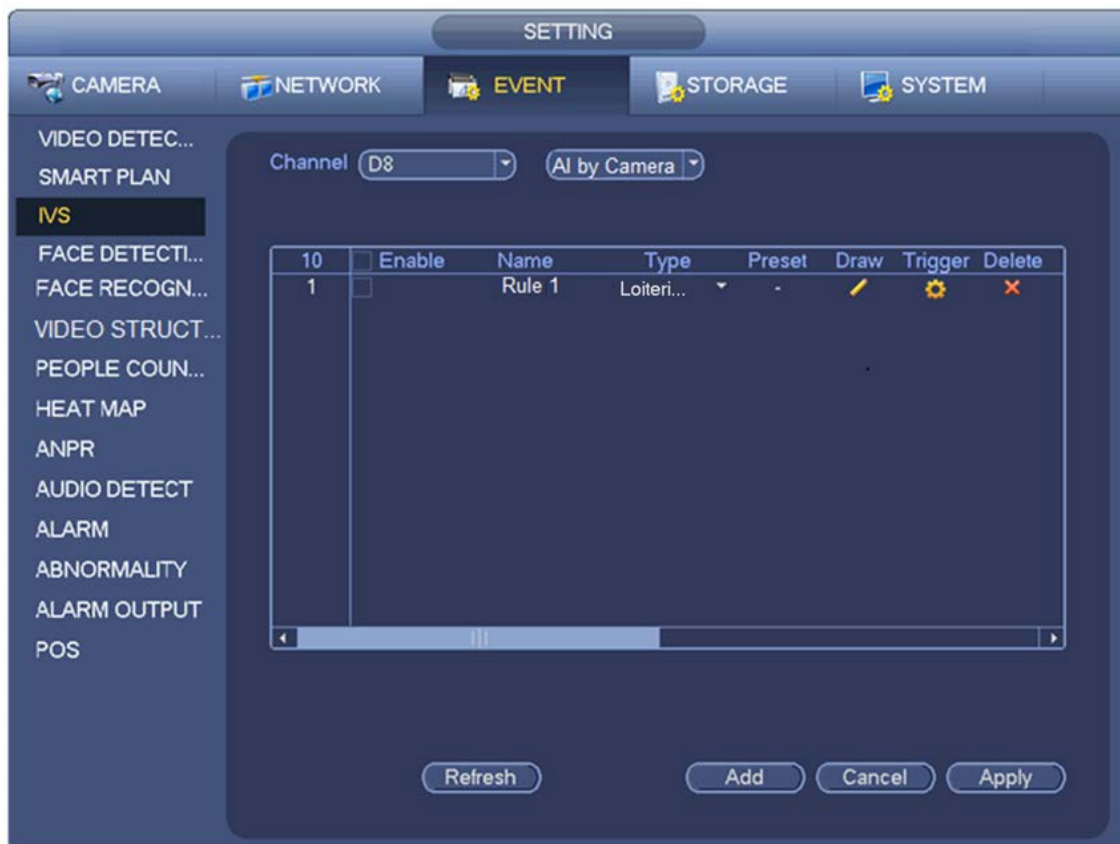



Figure 4-144

Click draw button  to draw the zone. See Figure 4-149.



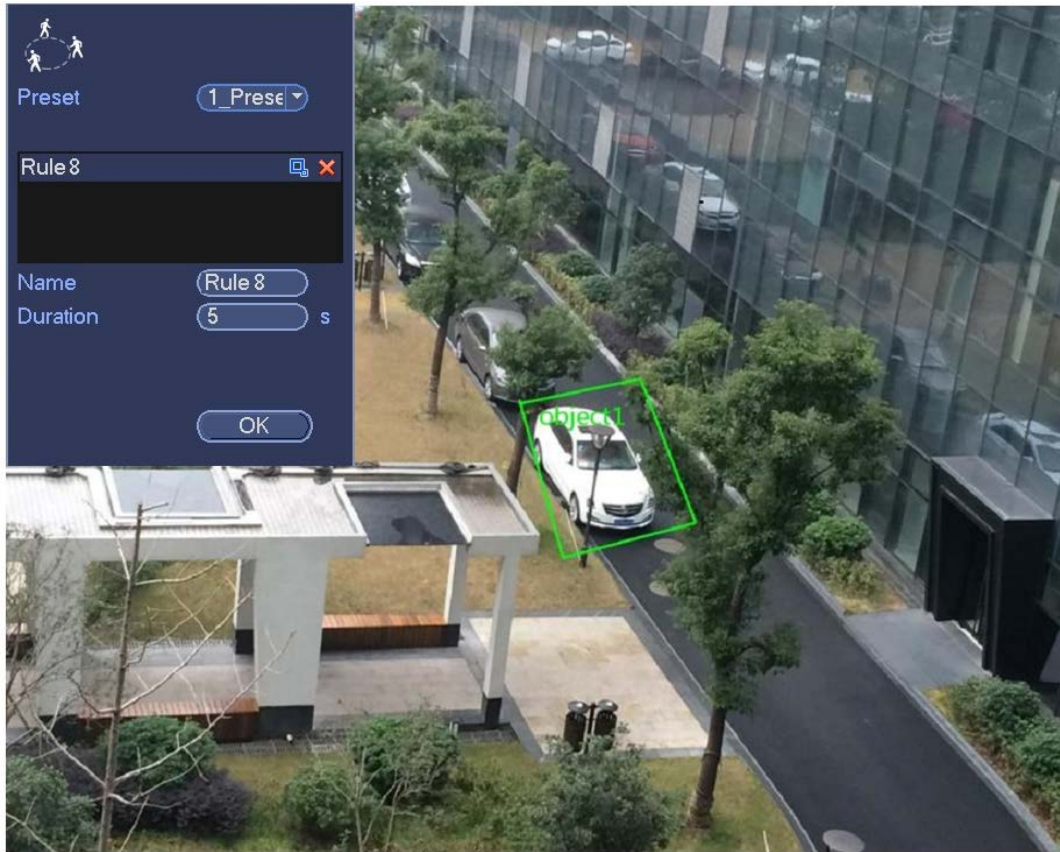



Figure 4-145

- Preset: Select a preset you want to use behavior analytics.
- Name: Input customized rule name.
- Duration: System can generate an alarm once the object is in the zone for the specified period.
- Target filter: Click , you can set filter object size. Each rule can set two sizes (min size/max size).

Once the object is smaller than the min size or larger than the max size, there is no alarm. Please make sure the max size is larger than the min size.

Now you can draw a rule. Left click mouse to draw a zone, until you draw a rectangle, you can right click mouse.

#### Tips

Click  to delete the corresponding rule.

Click , you can refer to the chapter 4.7.3.1 to set other parameters.

Click Apply to complete the setup.

### 4.7.3.10 Global Setup

After set one horizontal gauge and three vertical gauge and the actual distances between each gauge, the system can estimate the network camera internal parameters (internal geometrical features and optical properties) and external parameters (the network camera position and direction on the actual environment), it can confirm the actual distance on the current surveillance environment.

From main menu > Setting > Event > IVS, enter the following interface. See Figure 4-150.



Figure 4-146

Click Global config button, the interface is shown as below. See Figure 4-151.

- Channel: Please select a channel from the dropdown list.
- Preset: Select a preset you want to set the rule. Please note, you need to add a preset first, otherwise, you cannot see the preset dropdown list. If there is no preset, you can draw a rule in current channel.
- Calibration zone:
  - ✧ Click Add zone , you can draw a calibration zone at the left pane of the interface. Select a zone and then click Delete zone button; you can remove the selected zone.
  - ✧ Select gauge type (horizontal/tilt), you can set the corresponding length. You can draw three tilt gauges and one horizontal gauge at the left pane of the interface.
  - Select Width/Height and then click Verify, you can draw a line in the calibration zone, and then you can see its actual length.
  - Refresh preset: Click it to get the latest preset setup.

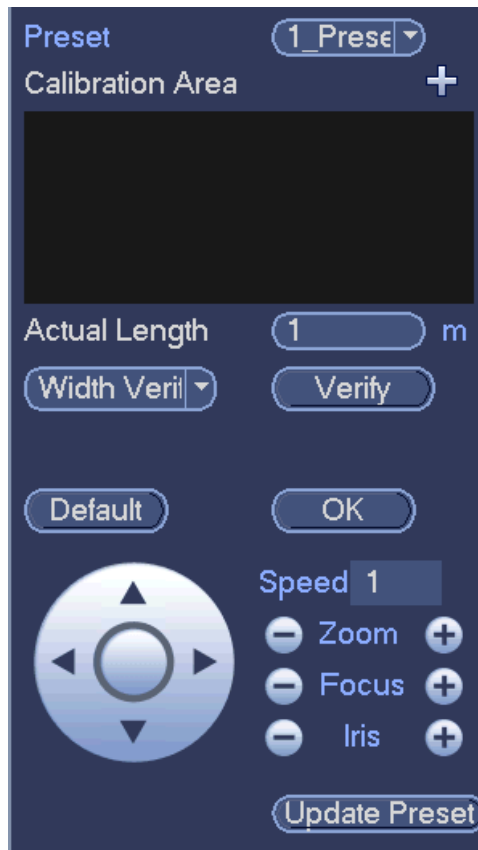

Figure 4-147

## 4.7.4 Face Detect

By the processing and analysis of videos from the camera, the system activates an alarm action when face information is detected.

Step 1 From main menu > Setting > Event > Face Detection, the interface is shown as in Figure 4-152.











Figure 4-148

Step 2 Configure the parameters. For details, see the following table.

Parameter	Description
Channel	Select the channel you want to set face detection.
Enable	Select the AI mode (AI by Camera or AI by Device) and select the Enable check box to enable it. AI by Camera: The front-end camera shall support face detection. AI by Device: Enable the AI function in NVR device and you can use any camera to do face detection.
Face ROI	NOTE This function is supported when AI by Camera is enabled.
RULE	Set the max size and min size of detection range when detecting face. Hold down the left mouse button and drag the four corners of the size box to adjust the size.
Period	Here you can set face detection period. System only enables face detection in the specified periods.
Alarm Out	When an alarm occurs, system enables peripheral alarm devices.
Latch	The system auto delays the alarm action for a specified period after the ending of the alarm. The value ranges from 0-300(Unit: second)

Parameter	Description
Alarm Upload	<p>Select the check box and the system uploads alarm signal to the network (including alarm center) when an alarm occurs.</p> <p> NOTE</p> <ul style="list-style-type: none"> <li>● Only some models support this function. See the actual situation.</li> <li>● You shall set the alarm center first. For details, see "4.8.1.9 Alarm Centre."</li> </ul>
Send Email	<p>System can send out email to alert you when an alarm occurs</p> <p> NOTE</p> <p>You shall set the Email first. For details, see "4.8.1.6 Email."</p>
Record Channel	<p>Select the check box and select the channel (supporting multi-check). When an alarm occurs, the NVR device activates the corresponding channel to take records.</p> <p> NOTE</p> <p>You shall enable smart record and auto record functions first. For details, see "4.1.4.5.1 Schedule Record."</p>
PTZ Activation	<p>Select the check box and click Setting to set the channel and actions. When an alarm occurs, the NVR device activates the corresponding channel to perform the PTZ action. For example, turning the PTZ to preset point X.</p> <p> NOTE</p> <p>You shall set the corresponding PTZ action first. For details, see "4.4.1 PTZ Settings."</p>
Post-Record	<p>System can delay the record for specified time after alarm ended. The value ranges from 10s to 300s.</p>
Tour	<p>Select the check box and select the tour channels. When an alarm occurs, the NVR local interface displays the tour image of the selected channel</p> <p> NOTE</p> <p>You shall set the tour interval and tour mode first. After the tour ends, the preview screen returns to the split mode before the tour.</p>
Snapshot	<p>Select the check box and select the channel for snapshot. When an alarm occurs, the NVR device triggers snapshot for the select channel.</p> <p> NOTE</p> <p>You shall enable smart record and auto record functions first. For details, see "4.1.4.5.1 Schedule Record."</p>
Log	<p>Select the check box and the NVR device records the alarm information in the log.</p>
Voice Prompts	<p>Select the check box and select the voice file in the File Name drop-down list. When an alarm occurs, the system plays the corresponding voice file.</p> <p> NOTE</p> <p>You shall add the voice file first. For details, see "4.10.3 Voice."</p>
Buzzer	<p>Select the check box and the NVR device triggers the buzzer when an alarm occurs.</p>

Step 3 Click Apply or OK to complete the configuration.

After enabling face detection, right click on the preview interface, select Preview Mode > AI mode. The AI preview interface is displayed. See Figure 4-153.



Figure 4-149

## 4.7.5 Face Recognition

The system supports to compare the detected faces with the configured faces in the face library.

### 4.7.5.1 Face Library Management

Only after the face library configuration, you can compare the detected face with the information in the face library. It includes creating face library, adding face images and face modeling.

#### NOTE

To protect personal privacy, the faces in the picture have been blurred.

#### 4.7.5.1.1 Creating Face Library

Step1 From main menu > Setting > Event > Face Recognition > Face Library.

The Face Library interface is displayed. See Figure 4-154.



Figure 4-150

Step2 Select the type in the Type drop-down list (including local and remote).

NOTE

Local means that the face information is save in the NVR device. Remote means that the face information is saved in the IPC.

Step3 Select the channel.

NOTE

This step is necessary only when the type is remote.

Step4 Click Add.

The Add interface is displayed. See Figure 4-155.

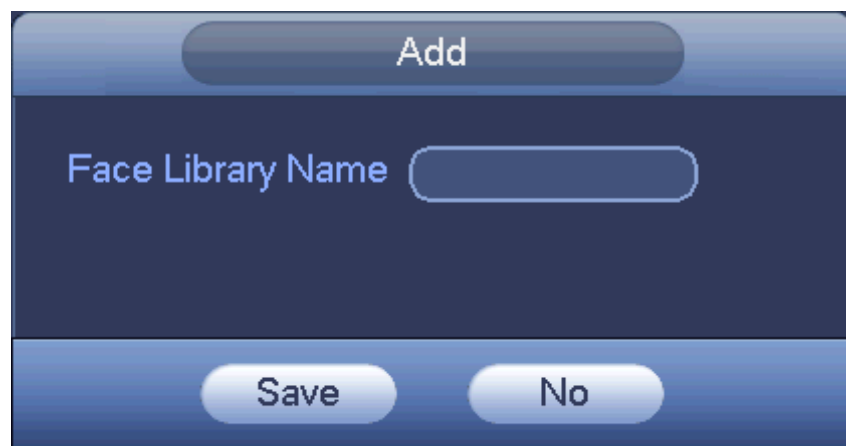

Figure 4-151



Step5 Enter the Face Library Name and click Save.

Save the face library successfully. The following interface is displayed. See Figure 4-156.



Figure 4-152

 NOTE

- Click the corresponding  to modify the library name
- Click  or click Delete after selecting the face library to delete the library.

#### 4.7.5.1.2 Registering Face Image

It is to register face images to the face library. It supports three ways: single register, batch register and detection register.

 NOTE

When you import images from the U flash disk, the image shall be smaller than 256K and the resolution shall be 200x200-6000x5000.

#### Single register

You can select single register when there are few images to register.

Step1 From main menu > Setting > Event > Face Recognition > Face Library.

The Face Library interface is displayed. See Figure 4-156.

Step2 Click  after the library you want to configure.

The Details interface is displayed. See Figure 4-157.

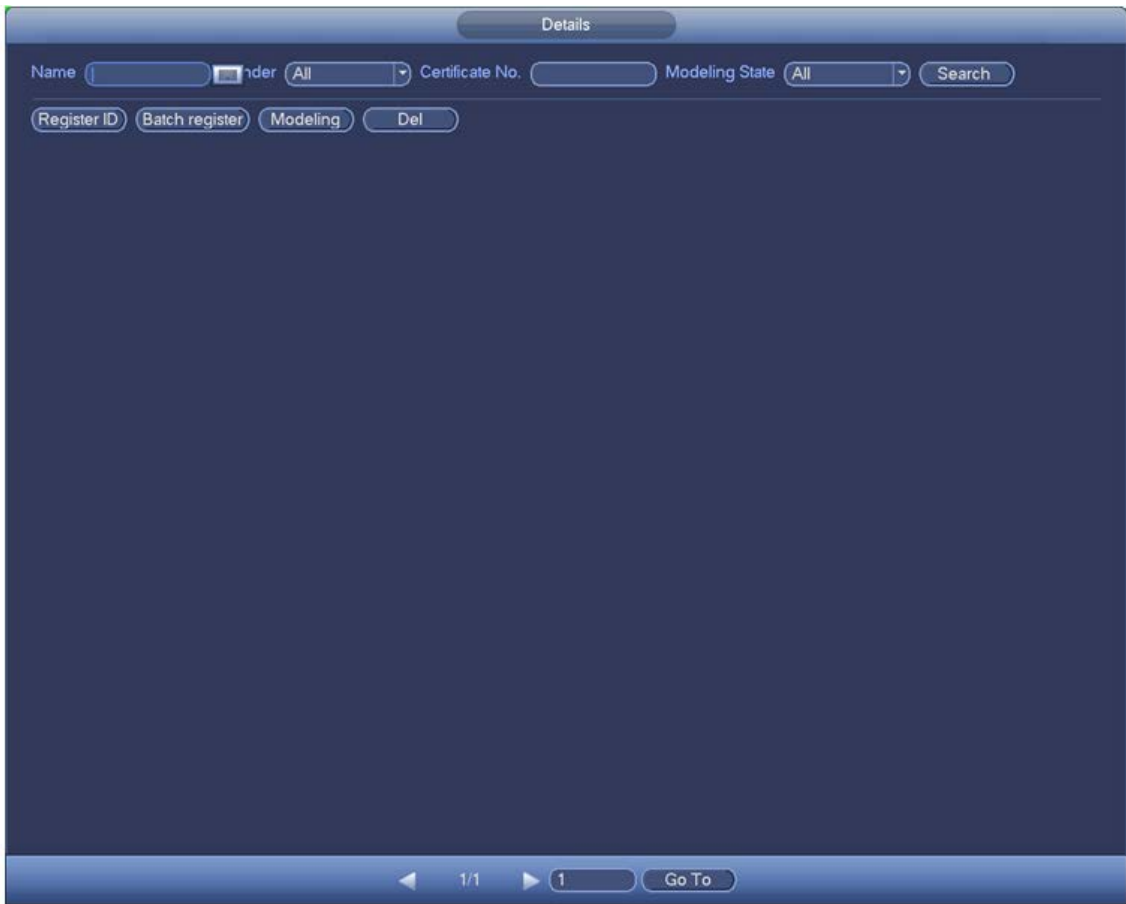

Figure 4-153

- Step3 Click Register ID.  
 The Register ID interface is displayed. See Figure 4-158.



Figure 4-154

Step4 Click  to add face image.

The Browse interface is displayed. See Figure 4-159.

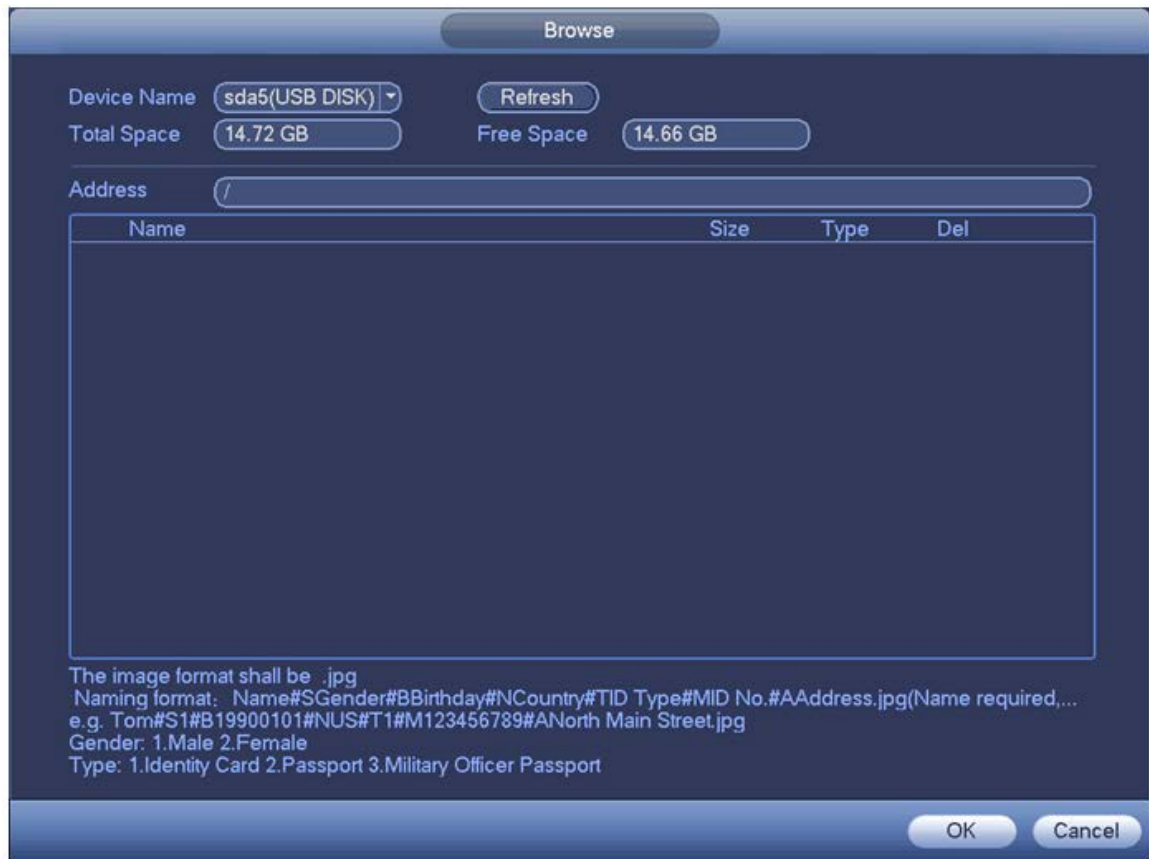

Figure 4-155

Step5 Select the image and enter the personal information. See Figure 4-160.



Figure 4-156

Step6 Click OK.



- The system displays “Register Successful” and returns to the Detail interface.
- Step7 Click Search.
- The system displays “Modeling Successful”. See Figure 4-161.

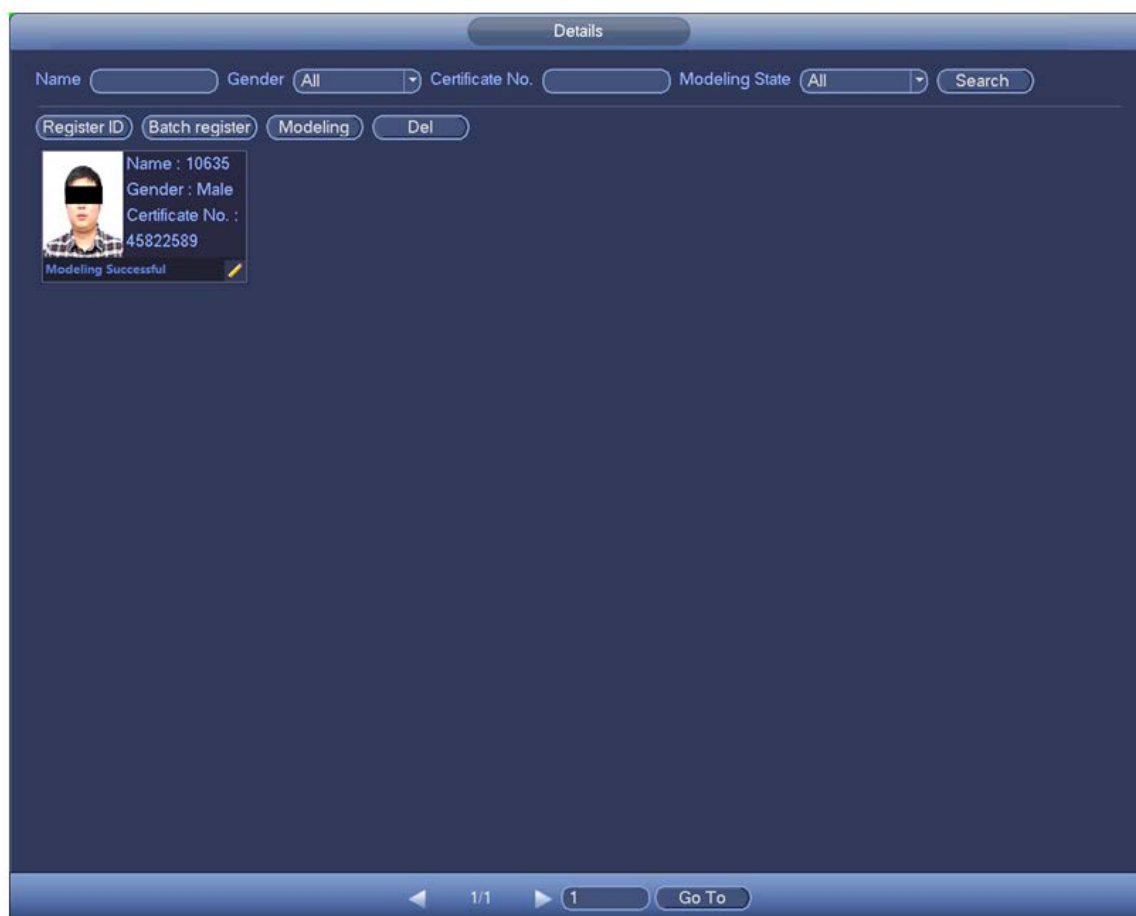

Figure 4-157

NOTE

In modeling means that the system is extracting the properties of the image. You can click Search to refresh the interface. If the modeling is failed, this image cannot work for face recognition.

### Batch Register

You can select batch register when there are many images to register.

Step1 Name the picture in accordance with the rule:

Name#SGender#BBirthday#NCountry#PProvince#TID type#MID No.#AAddress.jpg.

For example, Tom#S1#B1990-01-01#NUS# T2#M123456789 #ANorth Main Street.jpg.

For detailed naming rule introduction, see the following table.

NOTE

Name is required and others are optional.

Item	Description
Name	Enter the name.
Gender	Enter the number. 1: Male; 2: Female.
Birthday	Enter the number in the format of yyyy-mm-dd. E.g.: 2017-11-23.
Country	Enter the abbreviation of country name.
Province	Enter the province name.
City	Enter the city name.



Item	Description
Type	Enter the number.
ID No.	Enter the ID number.

Step2 Click Batch Register in Figure 4-157.

The Batch Register interface is displayed. See Figure 4-162.

Step3 Click Select file, max select 500 each time or click Select Folder, select the path and import the image.

Step4 Click OK to complete the batch register.

### Detection Register

The system supports to directly register the detected images to the face library.

 NOTE

It only supports to add face images to local PC.

Step1 Right click the mouse on the preview interface and select Preview Mode > AI mode.

The AI preview mode interface is displayed. See Figure 4-163.

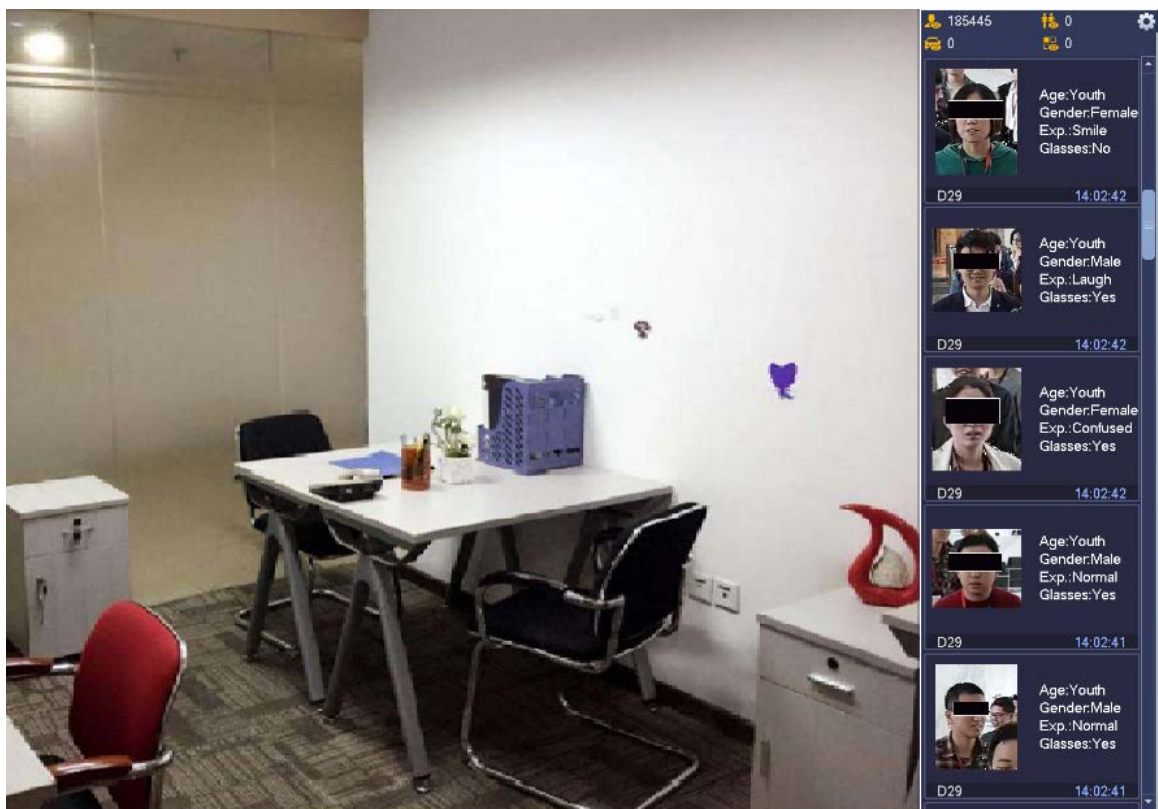

Figure 4-158

Step2 Double click the face image on the right.

The system starts to play the record to which the image belongs to. See Figure 4-164.

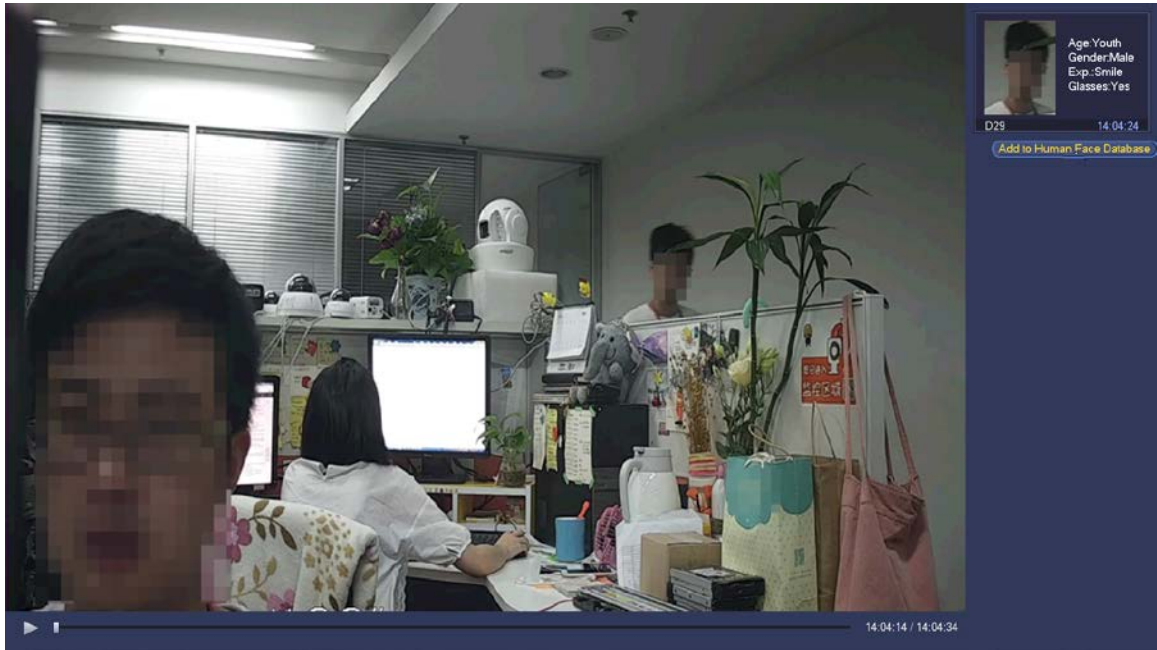

Figure 4-159

- Step3 Click Add to Human Face Database.  
The Register ID interface is displayed. See Figure 4-165.



Figure 4-160

- Step4 Select the face library you want to register to and enter the relevant information.  
Step5 Click OK to complete the register.

#### 4.7.5.2 Face Recognition Configuration

Through the analysis and processing of video images collected by the camera, system compares the detected faces and faces in the database, and then activates the linked alarm actions.

System supports face recognition by camera and face recognition by device. If both are enabled, system gives preference to face recognition by device.

#### 4.7.5.2.1 Face recognition by Camera

It is to enable AI by camera. The front-end camera shall support face detection.

Step1 From main menu > Setting > Event > Face Recognition > Face Recognition.

The Face Recognition interface is displayed. See Figure 4-166.



Figure 4-161

Step2 Select the channel number.

Step3 Select AI by Camera and select the Enable check box.

Step4 Configure the parameters. For details, see the following table.

Parameter	Description
Face ROI	Select the check box to enable it. NOTE System supports Face ROI when AI by camera is enabled.
Rule settings	Set the maximum size and minimum size of the detection range for face detection. Hold down the left mouse button and drag the four corners of the size box to adjust the dimensions.
Property settings	Set the items for face recognition, such as age, gender and glasses.
Period	Set the period only in which the configured alarm will be triggered.

Step5 Select the face library you want to enable.

Step6 (Optional) Click  to modify the similarity.

 NOTE

The higher the similarity, the higher the possibility to trigger the linked alarm.

Step7 Click .

The Trigger interface is displayed. See Figure 4-167.

 NOTE







For face library configuration, see chapter 4.7.5.1 Face Library Management.



Figure 4-162

Step8 Configure the trigger parameters. For details, see the following table.

Parameter	Note
Alarm Out	Connect alarm device (light, siren, etc.) at the alarm out port and the NVR device sends the alarm information to the alarm device when an alarm occurs.
Latch	The alarm extends for 0~300 seconds after the ending of alarm information.
Alarm Upload	Select the check box and NVR device uploads alarm signals to the network (including alarm center) when an alarm occurs.  NOTE Only some devices support this function. Please refer to the actual situation. The alarm center shall be set. For detailed operations, see chapter 5.11.2.10 Alarm Centre.

Parameter	Note
Send Email	Select the check box. NVR device sends an email to the appointed email box when an alarm occurs.  NOTE Email shall be set first. For details, see chapter 4.8.1.6 Email.
Record Channel	Select the check box and choose the specified record channel (multi-choice acceptable) . when an alarm occurs, NVR enables the channel to start video recording.  NOTE Intelligent Record and Automatic Record shall be already enabled. For details, see chapter 4.1.4.5 Schedule.
PTZ Activation	Select the check box. Click Setting and select the linkage PTZ channel and action. The NVR device links the channel to perform the corresponding PTZ action. E.g. PTZ of Channel one turns to preset point X.  NOTE The corresponding PTZ action shall be already set.
Post-Record	The video extends for 10~300 seconds after the ending of the alarm.
Tour	Select the check box and choose the channel for touring. The NVR local interface will work in tour and display the images of the selected channel.  NOTE The tour interval and mode shall be already set. When the alarm linked tour ends, the preview interface returns to the image segmentation model.
Snapshot	Select the check box and choose the channel for snapshot. NVR triggers snapshot for the selected channel when the alarm occurs.  NOTE Intelligent Record and Automatic Record shall be already enabled. For details, see chapter 4.1.4.5 Schedule.
Log	Select the check box. NVR records the alarm information in the log when the alarm occurs.
Voice Prompts	Select the check box. Select the corresponding voice file in the File Name. The system plays this voice file when the alarm occurs.  NOTE The corresponding voice file shall be already added. For details, see chapter 4.10.3 Voice.
Buzzer	Select the check box. NVR device calls the buzzer when the alarm occurs.

Step9 Click OK to go back to the face recognition interface.

Step10 Click Apply or OK to complete the configuration.

When face recognition is successful, the system displays as follows. See Figure 4-168.



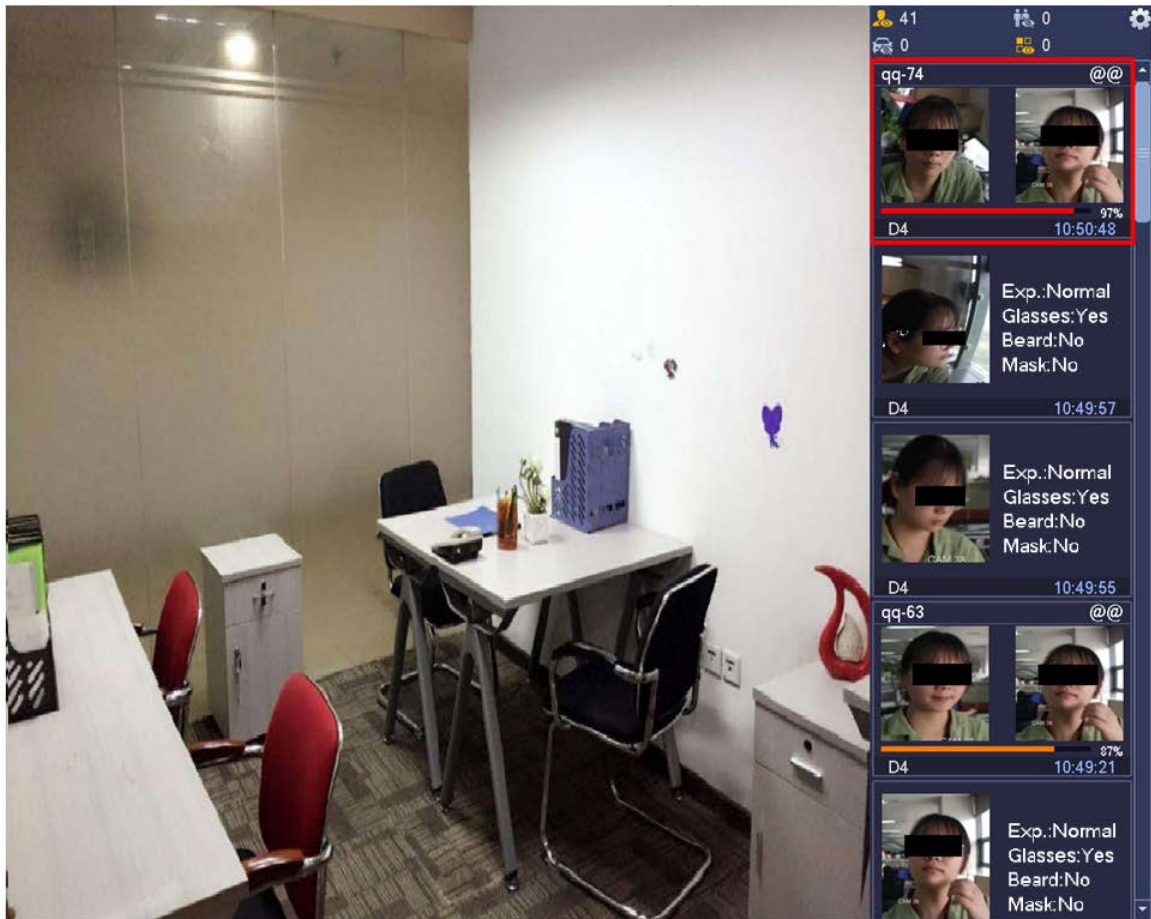

Figure 4-163

#### 4.7.5.2.2 Face recognition by Device

It is to enable AI by the NVR device. You can use any camera to do face recognition. The system supports to enable common mode and stranger mode.

- Common mode: When the face matching degree between the face detected by the system and the face in the database is greater than or equal to the similarity value, the system activates linked alarm action.
- Stranger mode: When the detected face cannot match with the images in the database, the system marks Stranger on the captured face image.



#### NOTE

Before enabling face recognition by device, you shall enable the face detection function in the corresponding channel. For details, see chapter 4.7.4 Face Detect .

Step1 Enter from main menu > Settings > Event > Face Recognition > Face Recognition.

The Face Recognition interface is displayed. See Figure 4-166.

Step2 Select the channel number

Step3 Select AI by Device and select the Enable check box.

System displays as follows. See Figure 4-169.



Figure 4-164

Step4 Enable Common Mode or Stranger Mode.

- Common Mode
  1. Click Common Mode and the system display as Figure 4-169.
  2. Click Target Face Database.  
The Face Library interface is displayed. See Figure 4-170

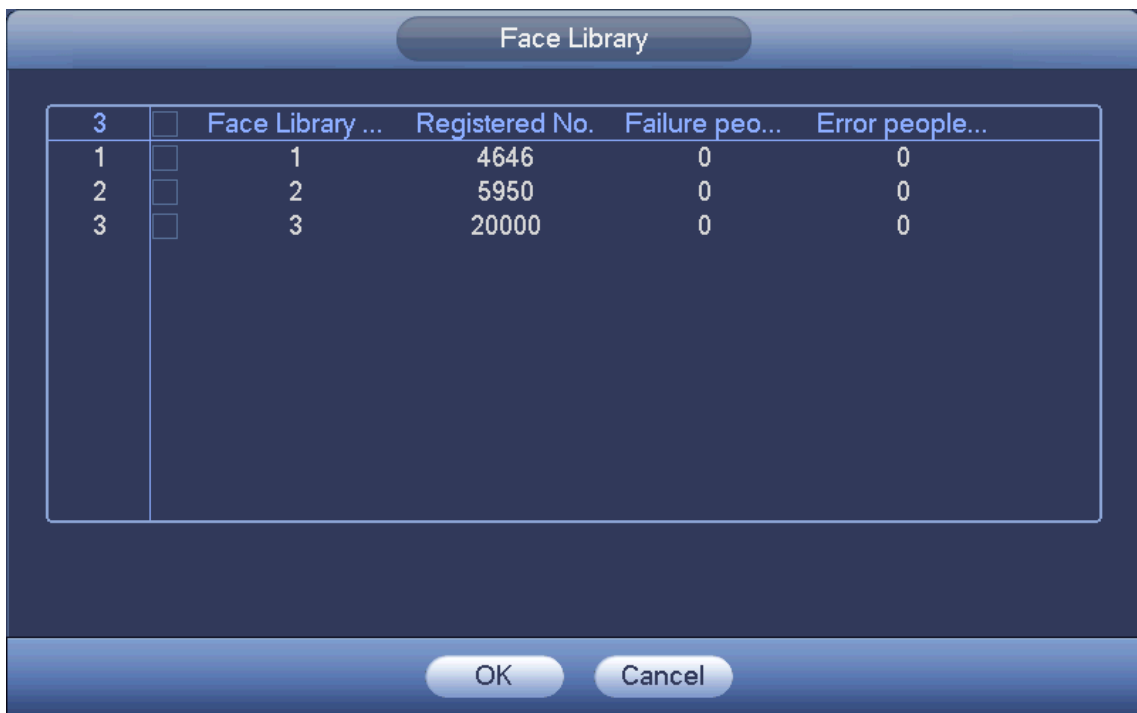



Figure 4-165

3. Select the face library and click OK.
4. (Optional) Click  and you can modify the similarity.



**NOTE**

The lower the similarity, the higher the alarm activation rate is.

5. Click .

The Trigger interface is displayed. See Figure 4-167.



**NOTE**

For face library configuration, see chapter 4.7.5.1 Face Library Management.

6. Configure the parameters. For details, see chapter 4.7.5.2.1 Step8.

- Stranger Mode

1. Click Stranger Mode and the system displays as follows. See Figure 4-171.



Figure 4-166

2. Select the Enable check box.
3. Configure the parameters.
4. Click Apply or OK to complete the configuration.

When a stranger is detected, the system marks Stranger on the snapped image on the right. See Figure 4-172.





Figure 4-167

## 4.7.6 Video Structurization

Video structurization includes personnel detection, face detection, vehicle detection and non-motor vehicle detection. After enabling the intelligent plan, the corresponding function can come into effect.

### NOTE

Video structurization includes AI by camera and AI by device.

- AI by camera: It means that the specific IPC itself supports intelligent analysis, and the NVR only needs to support the detection and display of intelligent alarm information from the IPC, and supports intelligent analysis configuration and video playback of the IPC.
- AI by camera: It means that the front-end IPC does not perform intelligent analysis, and it is intelligently analyzed by the NVR.

Step 1 From main menu > Setting > Event > Video Structurization.

The Video Structurization interface is displayed. See Figure 4-173.

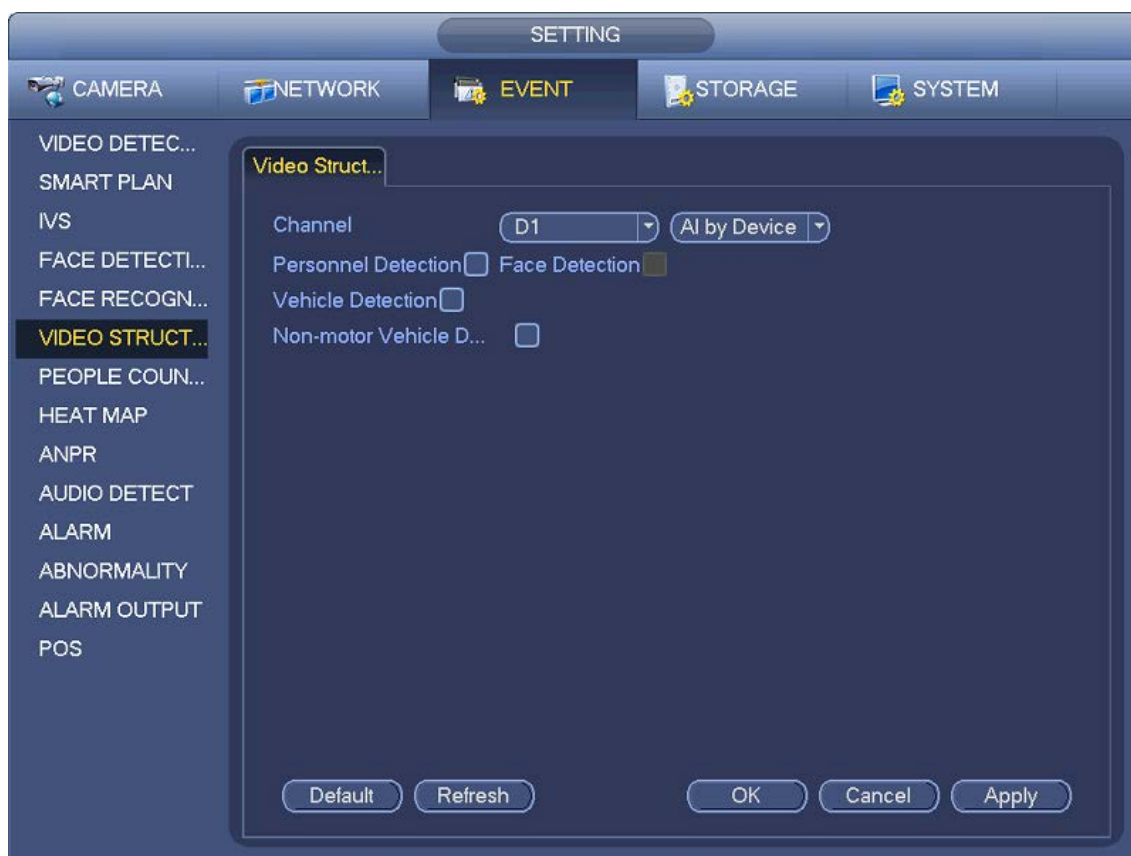



Figure 4-168

Step 2 Configure the parameters. For details, see the following table.

Parameter	Description
AI Type	Select the AI type. The system supports AI by camera and AI by device.  <b>NOTE</b> When you select AI by camra, you shall connect intelligent IPC on the front end.
Personnel Detection	Select Personnel Detection. When the human body information is detected, the system performs an alarm linkage action.
Face Detection	Select Face Detection. When the face information is detected, the system performs an alarm linkage action.  <b>NOTE</b> To enable face detection, you need to enable the personnel detection function first. For the rule setting of face detection, see chapter 4.7.4 Face Detect.
Vehicle Detection	Select Vehicle Detection. When the vehicle information is detected, the system performs an alarm linkage action.
Non-motor Vehicle Detection	Select Non-motor Vehicle Detection. When the non-motor vehicle information is detected, the system performs an alarm linkage action.

Step 3 Click Apply or OK to complete the configuration.

## 4.7.7 People Counting

System adopts video image and graphics analysis technology. System can calculate the entry/exit people amount in the specified zone on the video. It can generate an alarm when the amount has exceeded the threshold.

From main menu > Setting > Event > People counting, you can see an interface shown as in Figure 4-174.

- Enable: Check the box to enable people counting function.
- OSD overlay: Check the box here; you can view the people amount on the surveillance video.
- Rule setup: Click Set button, you can set people counting zone, name, and direction (entry/exit).
- Entry No.: It is to set people entry amount. System can generate an alarm once the amount has exceeded the threshold.
- Exit No.: It is to set people exit amount. System can generate an alarm once the amount has exceeded the threshold.
- Remaining No.: It is to set people staying amount in the zone. System can generate an alarm once the amount has exceeded the threshold.

You can refer to the chapter 4.7.1.1 motion detect to set other parameters.

Click OK to complete the setup.



Figure 4-169

After you set the people counting function, from main menu>Info>Event>People counting, you can view people counting statistics report. Please refer to chapter 4.7.1.1 Motion detect for detailed information.

## 4.7.8 Heat Map

Heat map technology can monitor the active objects distribution status on the specified zone during a period of time, and use the different colors to display on the heat map.

- Step 4 From main menu>Setting>Event>Heat map.  
Enter heat map interface. See Figure 4-175.



Figure 4-170

- Step 5 Select a channel number and then check the box to enable the function.  
Step 6 Click Setup button.  
Enter setup interface. See Figure 4-176.

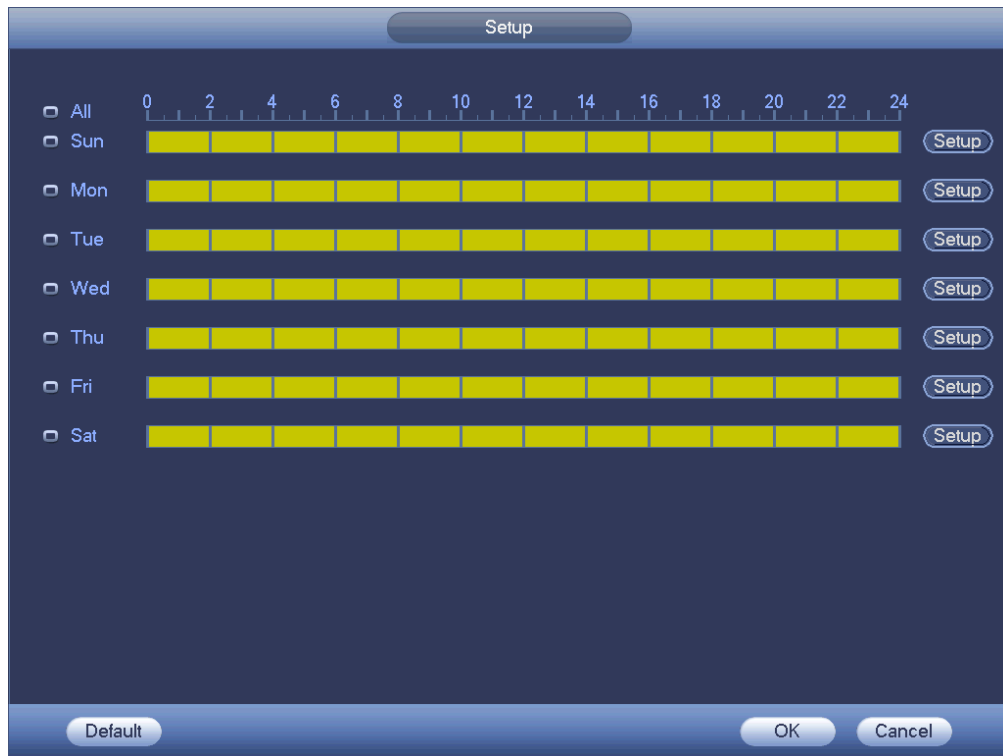

Figure 4-171

- Step 7 Set arm/disarm period. Refer to chapter 4.7.1.1 Motion detect for detailed setup information.  
 Step 8 Click Apply button to complete setup.

 **Note**

After set the heat map parameters, go to main menu>Info>Event>Heat map to view heat map report. Refer to chapter 4.10.2.3.3 for detailed setup information.

## 4.7.9 ANPR

### 4.7.9.1 Plate recognition settings

Device can generate an alarm when it detects the corresponding plate information. Please follow the steps listed below.

- Step 1 From main menu > Setting > Event > ANPR > Plate recognition.  
 Enter Plate Recognition interface. See Figure 4-177.



Figure 4-172

- Step 2 Select the Enable check box to enable ANPR.
- Step 3 Select a channel number and then click the Rule to set the plate recognition name and detection zone.
- Step 4 Click Regular, Blocklist or Allowlist tab to configure it.

 **Note**

Before activate blacklist alarm or allowlist alarm, you need to add the corresponding plate information. Refer to chapter 4.7.9.2 B/W list for detailed information.

- Regular: Device triggers an alarm when it detects any plate numbers.
- Blocklist: Device triggers an alarm when it detects plate number in the blacklist.
- Allowlist: Device triggers an alarm when it detects plate number in the allowlist.

### 4.7.9.2 B/W List

It is to set the blacklist and allowlist. It includes add, delete, import, export blacklist/allowlist. After setting the blacklist/allowlist, on the preview interface, the system displays red for blacklist plate numbers, green for allowlist plate numbers, and white for regular plate numbers.

#### Adding Blocklist/Allowlist

- Step 1 From main menu > Setting > Event > ANPR > B/W list.  
Enter B/W list interface. See Figure 4-178.





Figure 4-173

Step 2 Enter the plate number and then select the type as blocklist or allowlist.

Step 3 Click Add.

#### Deleting Blocklist/Allowlist

Set type as blocklist, allowlist or all, click Search, device displays the corresponding information.

- Select the check box in front of the plate number and then click Delete to delete a plate number. Or click  of the corresponding plate number to delete it.
- Click Clear to delete all plate information in the blocklist/allowlist.

#### Importing/exporting blocklist/allowlist

Device supports blocklist/allowlist import/export via the USB device. The imported file can be in the format of .csv and xlsx. The exported file is in the format of .csv.

- Importing blocklist/allowlist: Set the type as blocklist or allowlist and then click Import. Select the corresponding file and then click Open to import it.
- Export blocklist/allowlist: Set the type as blocklist or allowlist and then click Export. Select the file save path and then click Save.

### 4.7.10 Audio Detect

System can generate an alarm once it detect the audio is not clear, the tone color has changed or the is abnormal or audio volume changes.

From main menu>Setting>Event>Audio detect, you can see an interface shown as in Figure 4-179.

- Input abnormal: Check the box here, system can generate an alarm once the audio input is abnormal.
- Intensity change: Check the box here, system can generate an alarm once the audio volume becomes strong.
- Sensitivity: It refers to the audio recognition sensitivity. The higher the value is, the higher the sensitivity is.
- Threshold: It is to set intensity change threshold. The smaller the value is, the higher the sensitivity is.
- Log: Check the box here, system can record audio detect alarm log.

Refer to the chapter 4.7.1.1 Motion Detect to set other parameters.

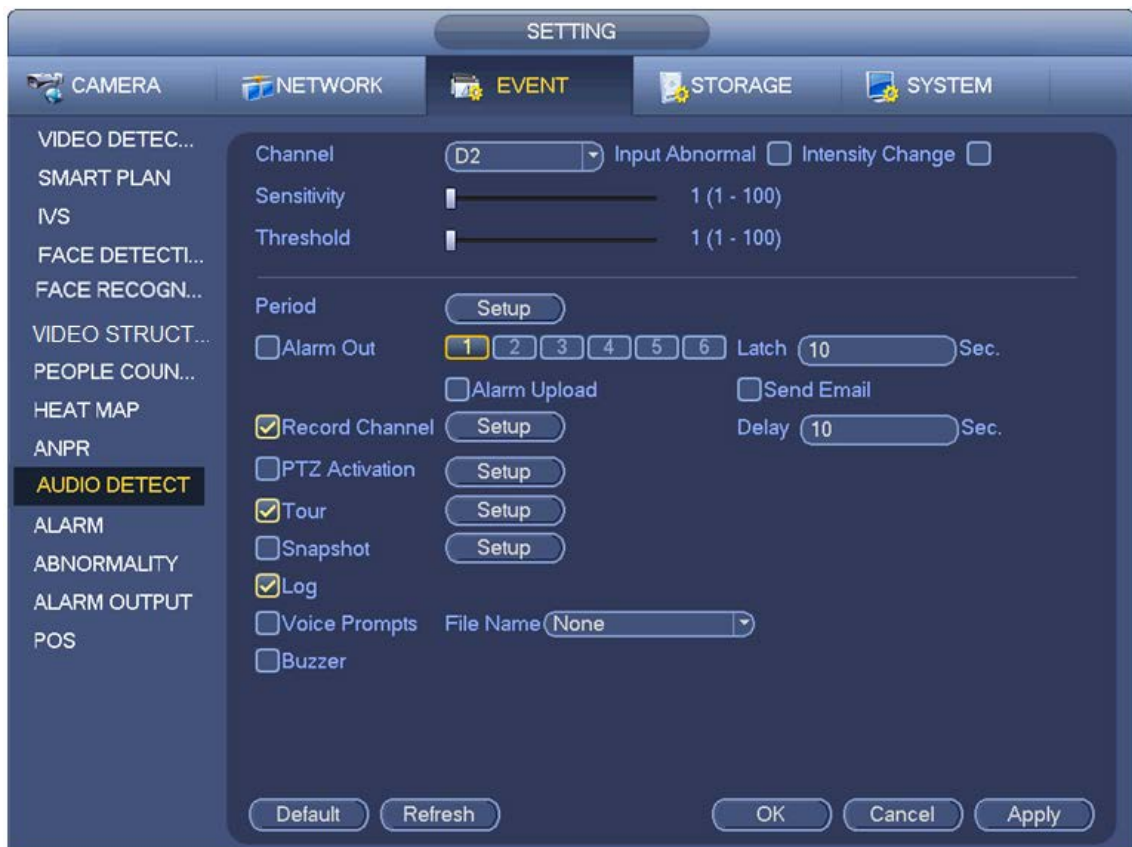

Figure 4-174

## 4.7.11 Alarm Settings

In the main menu, from Setting>Event>Alarm, you can see alarm setup interface.





- Alarm in: Here is for you to select channel number.

In the main menu, from Setting>Event>Alarm, you can see alarm setup interface. See Figure 4-180.

There are four alarm types. See Figure 4-180 to Figure 4-182.

- ✧ Local alarm: After connect the alarm device to the NVR alarm input port, system can trigger the corresponding alarm operations when there is alarm signal from the alarm input port to the NVR.
- ✧ Network alarm: NVR trigger corresponding alarm operations when it receives the alarm signal via the network transmission.
- ✧ IPC external alarm: When the network camera connected peripheral device has triggered an alarm, it can upload the alarm signal to the NVR via the network transmission. The system can trigger the corresponding alarm operations.



- ✧ IPC offline alarm: When the network connection between the NVR and the network camera is off, the system can trigger the corresponding alarm operations.
- Enable: Please you need to highlight this button to enable current function.
- Type: normal open or normal close.
- Period: Click set button, you can see an interface is shown as in Figure 4-184. There are two ways for you to set periods. There are max 6 periods in one day. There are four record types: regular, motion detection (MD), Alarm, MD & alarm.
- ✧ In Figure 4-184, Select icon  of several dates, all checked items can be edited together.  
Now the icon is shown as . Click  to delete a record type from one period.
- ✧ In Figure 4-184. Click button  after one date or a holiday, you can see an interface shown as in Figure 4-185. There are four record types: regular, motion detection (MD), Alarm, MD & alarm.
- PTZ activation: When an alarm occurred, system can activate the PTZ operation. The PTZ activation lasts an anti-dither period. See Figure 4-183.
- Anti-dither: Here you can set anti-dither time. The value ranges from 5 to 600s. The anti-dither time refers to the alarm signal lasts time. It can be seem as the alarm signal activation stays such as the buzzer, tour, PTZ activation, snapshot, channel record. The stay time here does not include the latch time. During the alarm process, the alarm signal can begin an anti-dither time if system detects the local alarm again. The screen prompt, alarm upload, email and etc will not be activated. For example, if you set the anti-dither time as 10 second, you can see the each activation may last 10s if the local alarm is activated. During the process, if system detects another local alarm signal at the fifth second, the buzzer, tour, PTZ activation, snapshot, record channel will begin another 10s while the screen prompt, alarm upload, email will not be activated again. After 10s, if system detects another alarm signal, it can generate an alarm since the anti-dither time is out.
- Alarm output: The number here is the device alarm output port. You can select the corresponding ports(s) so that system can activate the corresponding alarm device(s) when an alarm occurred.
- Latch: When the anti-dither time ended, the channel alarm you select in the alarm output may last the specified period. The value ranges from 1 to 300 seconds. This function is not for other alarm activation operations. The latch is still valid even you disable the alarm event function directly.
- Show message: System can pop up a message to alarm you in the local host screen if you enabled this function.
- Alarm upload: System can upload the alarm signal to the network (including alarm center and the WEB) if you enabled current function. System only uploads the alarm channel status. You can go to the WEB and then go to the Alarm interface to set alarm event and alarm operation. Please go to the Network interface to set alarm center information.
- Send email: System can send out the alarm signal via the email to alert you when alarm occurs. Once you enable the snap function, system can also send out an image as the attachment. Please go to the Main Menu>Setting >Network>Email interface to set.
- Record channel: you can select proper channel to record alarm video (Multiple choices).
  - ✧ You need to set alarm record mode as Schedule in Record interface (Main Menu>Advanced>Record). Please note the manual record has the highest priority. System record all the time no matter there is an alarm or not if you select Manual mode.

- ✧ Now you can go to the Schedule interface (Main Menu>Setting>Schedule) to set the record type, corresponding channel number, week and date. You can select the record type:Regular/MD/Alarm/MD&Alarm. Please note, you cannot select the MD&Alarm and MD (or Alarm) at the same time.
- ✧ Now you can go to the Encode interface to select the alarm record and set the encode parameter (Main Menu>Setting>Encode).
- ✧ Finally, you can set the alarm input as the local alarm and then select the record channel. The select channel begins alarm record when an alarm occurred. Please note system begins the alarm record instead of the MD record if the local alarm and MD event occurred at the same time.
- Tour: Here you can enable tour function when an alarm occurs. System supports 1/8-window tour. Please note the tour setup here has higher priority than the tour setup you set in the Display interface. Once there two tours are both enabled, system can enable the alarm tour as you set here when an alarm occurred. If there is no alarm, system implements the tour setup in the Display interface.
- Snapshot: You can enable this function to snapshot image when an alarm occurs.
- Buzzer: Highlight the icon to enable this function. The buzzer beeps when an alarm occurs.



Figure 4-175



Figure 4-176



Figure 4-177



Figure 4-178



Figure 4-179



Figure 4-180

Please highlight icon  to select the corresponding function. After setting all the setups please click save button.

## 4.7.12 Abnormality

There are three types: Disk/Network/User.

- ✧ Disk: Disk error, no disk, no space. See Figure 4-186.
- ✧ Network: Disconnection, IP conflict, MAC conflict. See Figure 4-187.
- ✧ User: Illegal login. Figure 4-188.
- Alarm output: Please select alarm activation output port (multiple choices).
- Less than: System can alarm you when the HDD space is less than the threshold you set here (For HDD no space type only).
- Attempts: In user interface, select illegal login from the dropdown list. Here you can set login attempts. The value ranges from 1 to 10.
- Lock time: In user interface, select illegal login from the dropdown list. Here you can set account lock time. The value ranges from 1 to 30 minutes.
- Latch: Here you can set corresponding delaying time. The value ranges from 1s-300s. System automatically delays specified seconds in turning off alarm and activated output after external alarm cancelled.
- Show message: system can pop up the message in the local screen to alert you when alarm occurs.
- Alarm upload: System can upload the alarm signal to the network (including alarm center) if you enabled current function. For disconnection event, IP conflict event and MAC conflict event, this function is null.
- Send email: System can send out email to alert you when alarm occurs.
- Buzzer: Highlight the icon to enable this function. The buzzer beeps when an alarm occurs.



Figure 4-181



Figure 4-182



Figure 4-183

### 4.7.13 Alarm output

From Main menu>Setting>Event>Alarm output, you can see an interface shown as in Figure 4-189. Here is for you to set proper alarm output (Auto/manual/stop). Connect the alarm device to the system alarm output port, and set the mode as auto, system can trigger the corresponding operations when an alarm occurs.

- Auto: Once an alarm event occurs, system can generate an alarm.
- Manual: Alarm device is always on the alarming mode.
- Stop: Disable alarm output function.

Click OK button of the alarm reset, you can clear all alarm output status.





Figure 4-184

Please highlight icon  to select the corresponding alarm output. After all the setups please click OK button.

## 4.7.14 POS

Connect the device with the POS, the device can receive the POS information and overlay corresponding info on the video.

### Note

- For the local-end, this function supports 1/4-window display and 1-window playback.
- This function is for the cashier of the supermarket and etc. The device can get the information from the POS and then overlay the txt information on the video.

Step 1 From main menu>Setting>System>POS, the interface is shown as below. See Figure 4-190.



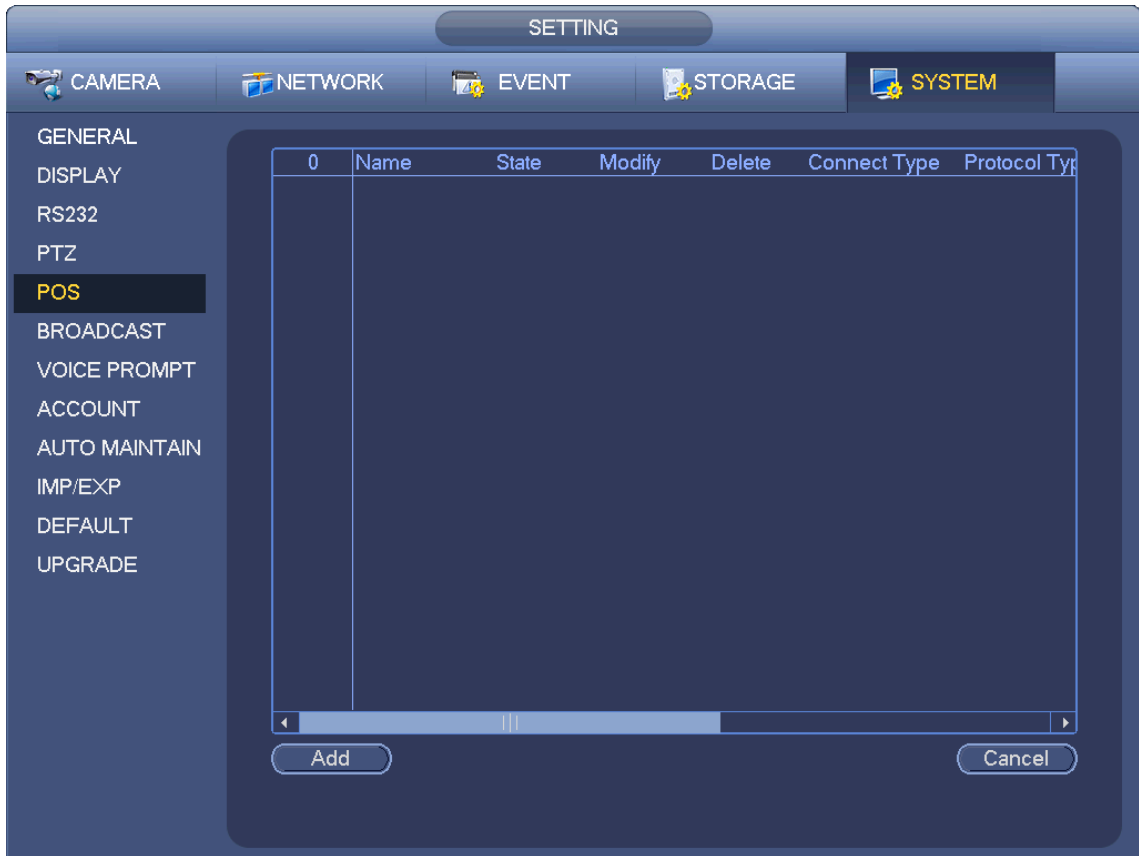



Figure 4-185

Step 2 Click Add button, the interface is shown as below. See Figure 4-191.

Set parameters.

- Enable: Check the box to enable POS function.
- Name: Set POS name.

1. Click 
2. Input POS name on the pop-up dialogue box.
3. Click OK button.

 **Note**

The POS name shall be unique.

System max supports 64 English letters.

- Event: Set POS arm/disarm period, record channel and etc. Click Setup to go to the interface. For detailed information, please refer to chapter 4.7.1.1 motion detect.
- Privacy: After enable this function, once the overlay information contain the privacy character, it displays as \*. For example, the privacy character is 12,56,89, the local preview and WEB surveillance information is shown as \*\*34\*\*7\*\* if the overlay information is 123456789. For detailed information, please refer to chapter 4.7.14.1 privacy setup.
- Protocol type: The default setup is POS.
- Connection type: It is to set and NVR connection mode. It includes UDP,TCP,RS232,RS485. After set the connection type, please click the Setup button to set the corresponding parameters. For detailed information, please refer to chapter 4.7.14.2 connection type.
- Convert: It is to set font type.

- Overlay: It is to set overlay mode. It includes turn and roll.
  - ✧ Turn: Once the overlay information has reached 8 lines, NVR turn to the next page.
  - ✧ Roll: Once the overlay information has reached 8 lines, NVR displays the next new line and delete the oldest line.
- Network overtime: Once there is no POS data for the specified period, NVR automatically deletes POS information after specified period.
- Font size: The overlay font size.
- Color: The overlay font color.
- POS Info: Check the box to overlay information on the local preview window.
- Advanced: Click  to enter advanced settings interface.
- Transaction start/transaction end: It is to set transaction start and end character. The overlay information only displays the character after the start string and before the end string. For example, the start character is 12 and the end character is 90, NVR displays 34567 on local preview and Web preview interface if the sending out information is 123456789.
- Line delimiter: After set the line delimiter, the overlay information after the delimiter is displayed in the new line. For example, the line delimiter is 45 and the overlay information is 123456789, NVR displays 123 in the first line and displays 6789 in the second line.
- Hex: Check the Hex to switch ASCII code.
- Case insensitive: Check the box to enable case insensitive function.
  - ✧ When this function is enabled, set the start character as “aa”, NVR cannot distinguish the upper and lower case when sending out information “11aA23456”. The NVR overlays information is “23456” on local surveillance and Web preview.
  - ✧ When this function is disabled, set the start character as “aa”, NVR can distinguish the upper and lower case when sending out information “11aA23456”. The NVR does not overlay information local surveillance and Web preview.

### 4.7.14.1 Privacy Setup

#### Step 1 Click Setup

Enter Setup interface. See Figure 4-191,



Figure 4-186

Step 2 Set privacy information.

Step 3 Click OK button.

#### 4.7.14.2 Connection type

- **Connection type is UDP or TCP.**

Step 1 Click Setup.

Enter Setup interface. See Figure 4-192.



Figure 4-187

Step 2 Source IP and port refers to POS IP address and port.

 **Note**

Destination IP and port refers to NVR IP address and port. System can auto get and display.

Step 3 Click OK to complete setup.

● **Connection mode is RS232 or RS485.**

Step 1 Click Setup.

Enter Setup interface. See Figure 4-193.



Figure 4-188

Step 2 Set address, baud rate, data bit, stop bit and parity.

 **Note**

Make sure the parameters here are the same with the POS setup.

Step 3 Click OK to complete setup.

## 4.8 Network

### 4.8.1 Network Settings

#### 4.8.1.1 TCP/IP

The TCP/IP interface is shown as in Figure 4-194.

- Network Mode : Includes multiple access, fault tolerance, and load balancing
  - ✧ Multiple-address mode: eth0 and eth1 operate separately. You can use the services such as HTTP, RTP service via eth0 or the eth1. Usually you need to set one default card (default setup

is eth0) to request the auto network service from the device-end such as DHCP, email, FTP and etc. In multiple-address mode, system network status is shown as offline once one card is offline.

- ✧ Network fault-tolerance: In this mode, device uses bond0 to communicate with the external devices. You can focus on one host IP address. At the same time, you need to set one master card. Usually there is only one running card (master card). System can enable alternate card when the master card is malfunction. The system is shown as offline once these two cards are both offline. Please note these two cards shall be in the same LAN.
- ✧ Load balance: In this mode, device uses bond0 to communicate with the external device. The eth0 and eth1 are both working now and bearing the network load. Their network load are general the same. The system is shown as offline once these two cards are both offline. Please note these two cards shall be in the same LAN.

- Default Network Card: Please select eth0/eth1/bond0(optional) after enable multiple-access function
- Main Network Card: Please select eth0/eth1 (optional).after enable multiple access function.

**Note: The dual-Ethernet port series support the above three configurations and supports functions as multiple-access, fault-tolerance and load balancing.**

- IP Version: There are two options: IPv4 and IPv6. Right now, system supports these two IP address format and you can access via them.
- MAC address: The host in the LAN can get a unique MAC address. It is for you to access in the LAN. It is read-only.
- IP address: Here you can use up/down button (▲▼) or input the corresponding number to input IP address. Then you can set the corresponding subnet mask the default gateway.
- Default gateway: Here you can input the default gateway. Please note system needs to check the validity of all IPv6 addresses. The IP address and the default gateway shall be in the same IP section. That is to say, the specified length of the subnet prefix shall have the same string.
- DHCP: It is to auto search IP. When enable DHCP function, you cannot modify IP/Subnet mask /Gateway. These values are from DHCP function. If you have not enabled DHCP function, IP/Subnet mask/Gateway display as zero. You need to disable DHCP function to view current IP information. Besides, when PPPoE is operating, you cannot modify IP/Subnet mask /Gateway.
- MTU: It is to set MTU value of the network adapter. The value ranges from 1280-7200 bytes. The default setup is 1500 bytes. Please note MTU modification may result in network adapter reboot and network becomes off. That is to say, MTU modification can affect current network service. System may pop up dialog box for you to confirm setup when you want to change MTU setup. Click OK button to confirm current reboot, or you can click Cancel button to terminate current modification. Before the modification, you can check the MTU of the gateway; the MTU of the NVR shall be the same as or is lower than the MTU of the gateway. In this way, you can reduce packets and enhance network transmission efficiency.

The following MTU value is for reference only.

- ✧ 1500: Ethernet information packet max value and it is also the default value. It is the typical setup when there is no PPPoE or VPN. It is the default setup of some router, switch or the network adapter.
- ✧ 1492: Recommend value for PPPoE.
- ✧ 1468: Recommend value for DHCP.
- Preferred DNS server: DNS server IP address.
- Alternate DNS server: DNS server alternate address.

- Transfer mode: Here you can select the priority between fluency/video qualities.
- LAN download: System can process the downloaded data first if you enable this function. The download speed is 1.5X or 2.0X of the normal speed.
- LAN download: System can process the downloaded data first if you enable this function. The download speed is 1.5X or 2.0X of the normal speed.

After completing all the setups please click save button, system goes back to the previous menu.



Figure 4-189

### 4.8.1.2 Port

The port setup interface is shown as in Figure 4-195.

- Max connection: The max client login amount (such as WEB, platform, cellphone and etc). The value ranges from 1 to 128(default).
- TCP port: Default value is 37777.
- UDP port: Default value is 37778.
- HTTP port: Default value is 80.
- HTTPS port: Default value is 443.
- RTSP port: Default value is 554.

**Important: System needs to reboot after you changed and saved any setup of the above four ports. Please make sure the port values here do not conflict.**



Figure 4-190

### 4.8.1.3 PPPoE

PPPoE interface is shown as in Figure 4-196.

Input "PPPoE name" and "PPPoE password" you get from your ISP (Internet service provider).

Click save button, you need to restart to activate your configuration.

After rebooting, NVR will connect to internet automatically. The IP in the PPPoE is the NVR dynamic value. You can access this IP to visit the unit.



Figure 4-191

#### 4.8.1.4 DDNS

DDNS(Dynamic Domain Name Server) is to dynamically refresh the DNS domain name and IP address if the device IP address has changed frequently. The user can use the domain to access the device.

##### Preparation

Before the operation, make sure the device supports DNS type and go to the DDNS service provider website to register the domain name via the PC.



##### Note

After you successfully registered and logged in the DDNS website, you can view all connected device information of current login user.

DDNS setup interface is shown as in Figure 4-197.

- Type/Host IP:
  - ✧ Dyn dns DDNS is members.dyndns.org.
  - ✧ NO-IP DDNS is dynupdate.no-ip.com.
  - ✧ CN99 DDNS is members.3322.org.
- Domain Name: The domain name registered on the DDNS service provider website.
- User name/password: Input the user name and password got from the DDNS service provider. Make sure you have logged in the DDNS service provider website to register an account (user name and password).
- Interval: After DDNS boots up, it sends out refresh query regularly. The unit is minute.

Click Apply or Save to complete setup. Open a browser and input domain name, click Enter button.



The setting is right if you can view device WEB interface. Otherwise, please check the parameters.

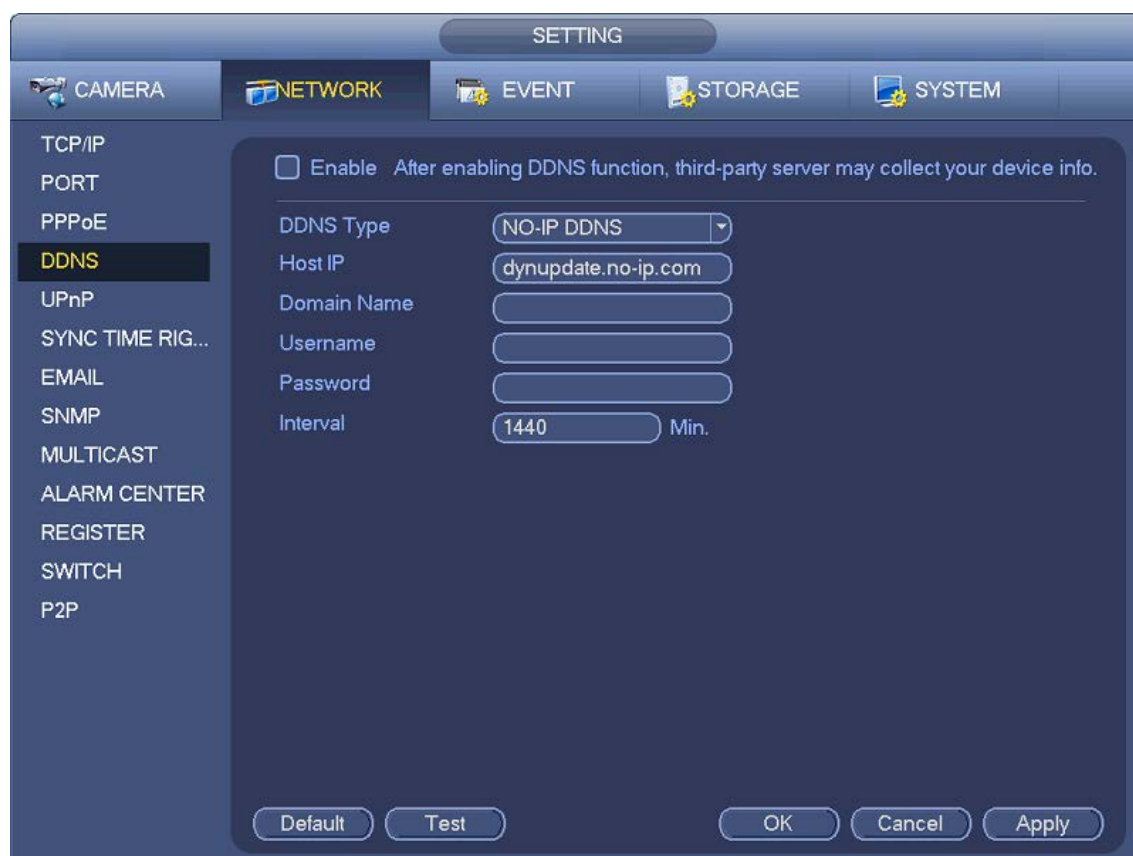

Figure 4-192

#### 4.8.1.5 UPnP

The UPNP protocol is to establish a mapping relationship between the LAN and the WAN. Please input the router IP address in the LAN in Figure 4-194. See Figure 4-198.

- Enable: Enable or disable the UPNP function of the device.
- Status: When the UPNP is offline, it shows disable. When the UPNP works it shows Enable.
- LAN IP: It is the router IP in the LAN.
- WAN IP: It is the router IP in the WAN.
- Port Mapping list: The port mapping list here is the one to one relationship with the router's port mapping setting.
- List:
  - ✧ Service name: Defined by user.
  - ✧ Protocol: Protocol type
  - ✧ Internal port: Port that has been mapped in the router.
  - ✧ External port: Port that has been mapped locally.
- Default: UPNP default port setting is the HTTP, TCP and UDP of the NVR.

Double click one item; you can change the corresponding mapping information. See Figure 4-199.

**Important:**

When you are setting the router external port, please use 1024~5000 port. Do not use well-known port 1~255 and the system port 256~1023 to avoid conflict.

For the TCP and UDP, please make sure the internal port and external port are the same to guarantee the proper data transmission.



Figure 4-193



Figure 4-194

## 4.8.1.6 Email

The email interface is shown as below. See Figure 4-200.

- SMTP server: Please input your email SMTP server IP here.
- Port: Please input corresponding port value here.
- User name: Please input the user name to login the sender email box.
- Password: Please input the corresponding password here.
- Sender: Please input sender email box here.
- Title: Please input email subject here. System support English character and Arabic number. Max 32-digit.
- Receiver: Please input receiver email address here. System max supports 3 email boxes. System automatically filters same addresses if you input one receiver repeatedly.
- SSL enable: System supports SSL encryption box.
- Interval: The send interval ranges from 0 to 3600 seconds. 0 means there is no interval.
- Health email enable: Please check the box here to enable this function. This function allows the system to send out the test email to check the connection is OK or not.
- Interval: Please check the above box to enable this function and then set the corresponding interval. System can send out the email regularly as you set here. Click the Test button, you can see the corresponding dialogue box to see the email connection is OK or not.

Please note system will not send out the email immediately when the alarm occurs. When the alarm, motion detection or the abnormality event activates the email, system sends out the email according to the interval you specified here. This function is very useful when there are too many emails activated by the abnormality events, which may result in heavy load for the email server.

The screenshot shows a web management console with a 'SETTING' header and a navigation menu on the left. The 'EMAIL' option is selected in the menu. The main configuration area contains the following fields and controls:

- Enable
- SMTP Server: MailServer | Port: 25 (1~65535)
- Anonymous
- Username: [ ] | Password: [ ]
- Receiver: [ ]
- Sender: [ ]
- Subject: NVR ALERT |  Attachment
- Encryption Type: NONE
- Interval: 120 Sec.
- Health Enable | 60 Min.
- Test button
- Default, OK, Cancel, Apply buttons at the bottom.

Figure 4-195

### 4.8.1.7 SNMP

SNMP is an abbreviation of Simple Network Management Protocol. It provides the basic network management frame of the network management system. The SNMP widely used in many environments. It is used in many network device, software and system.

You can set in the following interface. See Figure 4-201.



Figure 4-196

Please enable the SNMP function. Use the corresponding software tool (MIB Builder and MG-SOFT MIB Browser). You still need two MIB file: BASE-SNMP-MIB, NVR-SNMP-MIB) to connect to the device. You can get the device corresponding configuration information after successfully connection.

Please follow the steps listed below to configure.

- In Figure 4-201, check the box to enable the SNMP function. Input the IP address of the PC than is running the software in the Trap address. You can use default setup for the rest items.
- Compile the above mentioned two MIB file via the software MIB Builder.
- Run MG-SOFT MIB Browser to load the file from the previous step to the software.
- Input the device IP you want to manage in the MG-SOFT MIB Browser. Please set the corresponding version for your future reference.
- Open the tree list on the MG-SOFT MIB Browser; you can get the device configuration. Here you can see the device has how many video channels, audio channels, application version and etc.

#### Note

**Port conflict occurs when SNMP port and Trap port are the same.**

## 4.8.1.8 Multicast

Multicast setup interface is shown as in Figure 4-202.



Figure 4-197

Here you can set a multiple cast group. Please refer to the following sheet for detailed information.

- IP multiple cast group address  
-224.0.0.0-239.255.255.255  
-“D” address space
  - The higher four-bit of the first byte=“1110”
- Reserved local multiple cast group address  
-224.0.0.0-224.0.0.255  
-TTL=1 When sending out telegraph  
-For example  
224.0.0.1 All systems in the sub-net  
224.0.0.2 All routers in the sub-net  
224.0.0.4 DVMRP router  
224.0.0.5 OSPF router  
224.0.0.13 PIMv2 router
- Administrative scoped addressees  
-239.0.0.0-239.255.255.255  
-Private address space
  - Like the single broadcast address of RFC1918
  - Cannot be used in Internet transmission
  - Used for multiple cast broadcast in limited space.

Except the above mentioned addresses of special meaning, you can use other addresses. For example:

Multiple cast IP: 235.8.8.36

Multiple cast PORT: 3666.

After you logged in the Web, the Web can automatically get multiple cast address and add it to the multiple cast groups. You can enable real-time monitor function to view the view.

Please note multiple cast function applies to special series only.

### 4.8.1.9 Alarm Centre

This interface is reserved for you to develop. See Figure 4-203.

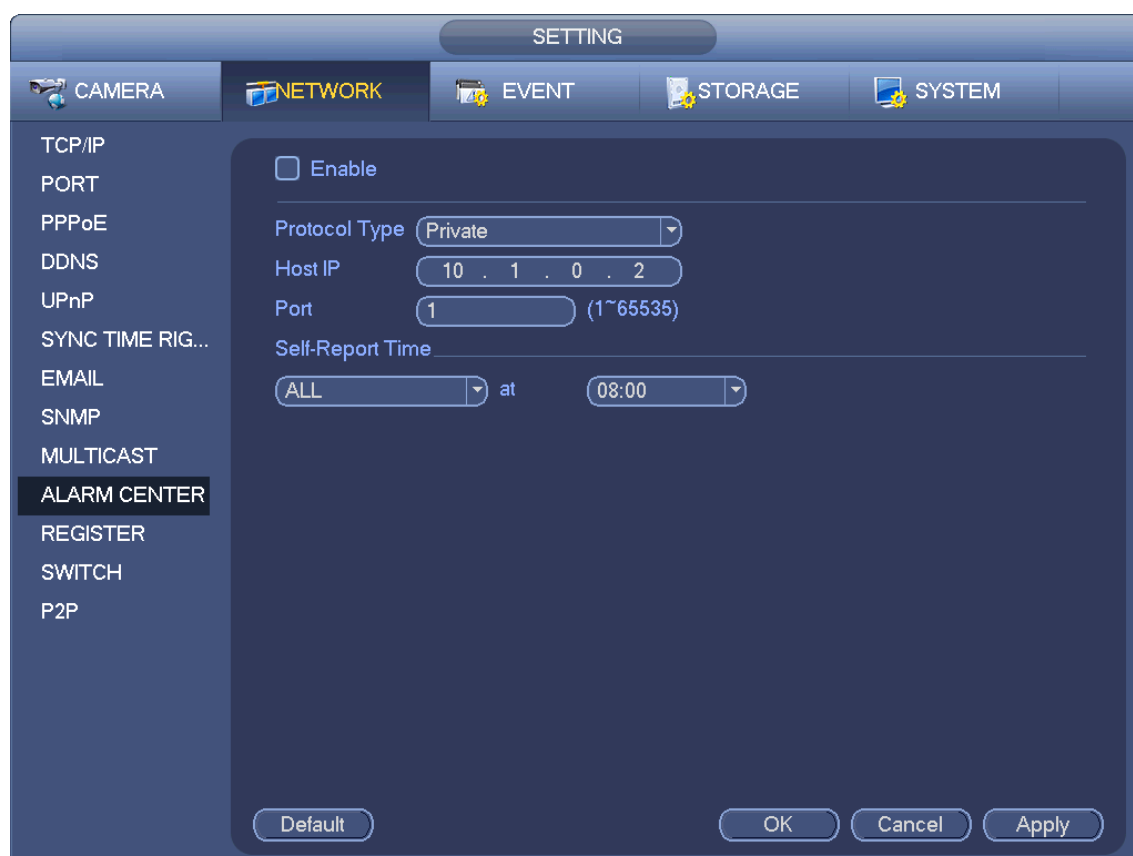

Figure 4-198

### 4.8.1.10 P2P

P2P is a kind of convenient private network penetration technology. You do not need to apply for dynamic domain name, doing port mapping or deploying transit server. You can add NVR devices through the below way to achieve the purpose of managing multiple NVR devices at the same time.

- Scan the QR code, download mobile app, and then register an account. For details, see Mobile App Operation.
- Log in [www.gotop2p.com](http://www.gotop2p.com), register an account, and then add device via the serial number. For details, see Introduction of P2P Operations which is available in the disk delivered with the device.

## CAUTION

Connect the NVR device to the Internet, otherwise P2P can not run properly.

Step 1 Enter from main menu -> Setting -> Network -> P2P.

The P2P interface is displayed. See Figure 4-204.



Figure 4-199

### NOTE

- P2P is enabled by default.
- When P2P is enabled and the device is connected to the Internet, it displays Online in the Status box. We need to collect information like IP address, MAC address, device name and device SN. All collected information is used only for the purpose of remote access.

Step 2 Click Next to complete the setting.

If system displays Online in the Status box, P2P registration is successful.

## Mobile APP Operation

The following contents are introduced in the example of mobile App.

Step 1 Scan the QR code to download and install the mobile App.

Step 2 Select Camera and enter the main interface.

Step 3 Register device in the mobile App:

- 1) Click  and select Device Manager. See Figure 4-205.



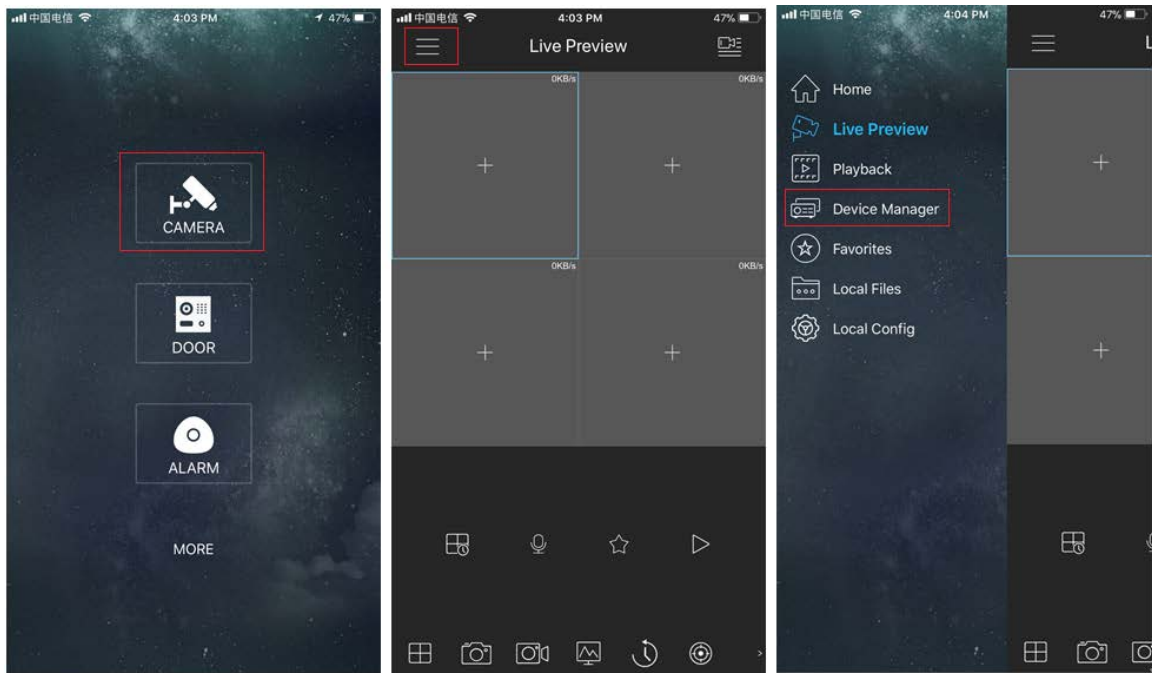



Figure 4-200

- 2) Click  and enter the Add Device interface.



**NOTE**

Mobile App supports device initialization.

- 3) Select Wired Device -> P2P to enter the P2P interface.
- 4) Click the QR code icon behind the SN to enter the QR code scan interface.
- 5) Scan the device label or scan the SN QR code got by entering from main menu -> Setup -> Network -> P2P. When the scan is successful, the device SN will be displayed in the SN item.
- 6) Enter name and password.

Step 4 After device registration on mobile App, click Start Preview and you can see the monitor screen.

## 4.8.2 Network Test

In this interface, you can see network test and network load information.

### 4.8.2.1 Network Test

From main menu>Info-Network>Test, the network test interface is shown as in Figure 4-206.

- Destination IP: Please input valid IPV4 address and domain name.
- Test: Click it to test the connection with the destination IP address. The test results can display average delay and packet loss rate and you can also view the network status as OK, bad, no connection and etc.
- Network Sniffer backup: Please insert USB2.0 device and click the Refresh button, you can view the device on the following column. You can use the dropdown list to select peripheral device. Click Browse button to select the snap path. The steps here are same as preview backup operation.



You can view all connected network adapter names (including Ethernet and PPPoE), you can click the button  on the right panel to begin Sniffer. Click the grey stop button to stop. Please note system cannot Sniffer several network adapters at the same time.

After Sniffer began, you can exit to implement corresponding network operation such as login WEB, monitor. Please go back to Sniffer interface to click  stop Sniffer. System can save the packets to the specified path. The file is named after "Network adapter name+time". You can use software such as Wireshark to open the packets on the PC for the professional engineer to solve complicated problems.



Figure 4-201

### 4.8.2.2 Network Load

From main menu>Info-Network>Load, network load is shown as in Figure 4-207. Here you can view the follow statistics of the device network adapter.

Here you can view information of all connected network adapters. The connection status is shown as offline if connection is disconnected. Click one network adapter, you can view the flow statistics such as send rate and receive rate at the top panel.

#### Note

- It is to display LAN1 network load by default.
- View one LAN network load by one time.

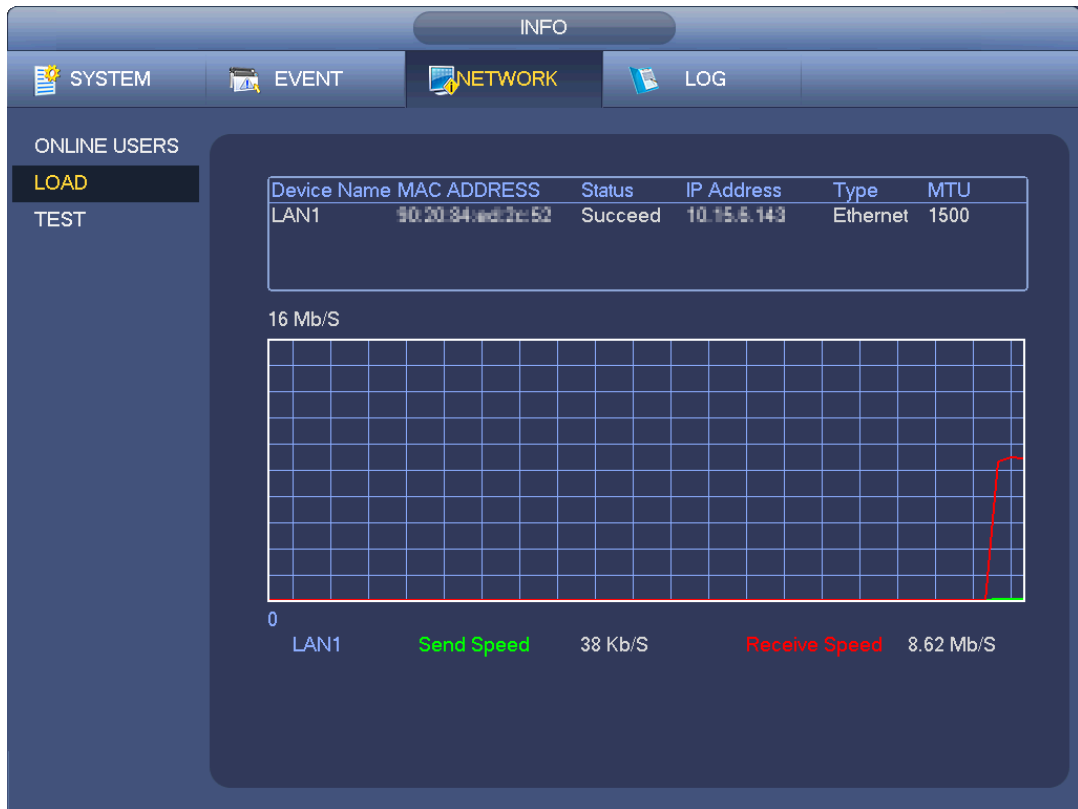

Figure 4-202

## 4.9 Storage

Here you can view HDD information such as type, status, total capacity, record time and etc. The operation includes format, resume from error, change HDD property (Read write, Read-only). Here you can also set alarm and HDD storage position.

### 4.9.1 Basic

It is to manage HDD storage space.

Step 1 From main menu>Setup>Storage>Basic.

Enter Basic interface. See Figure 5-39.

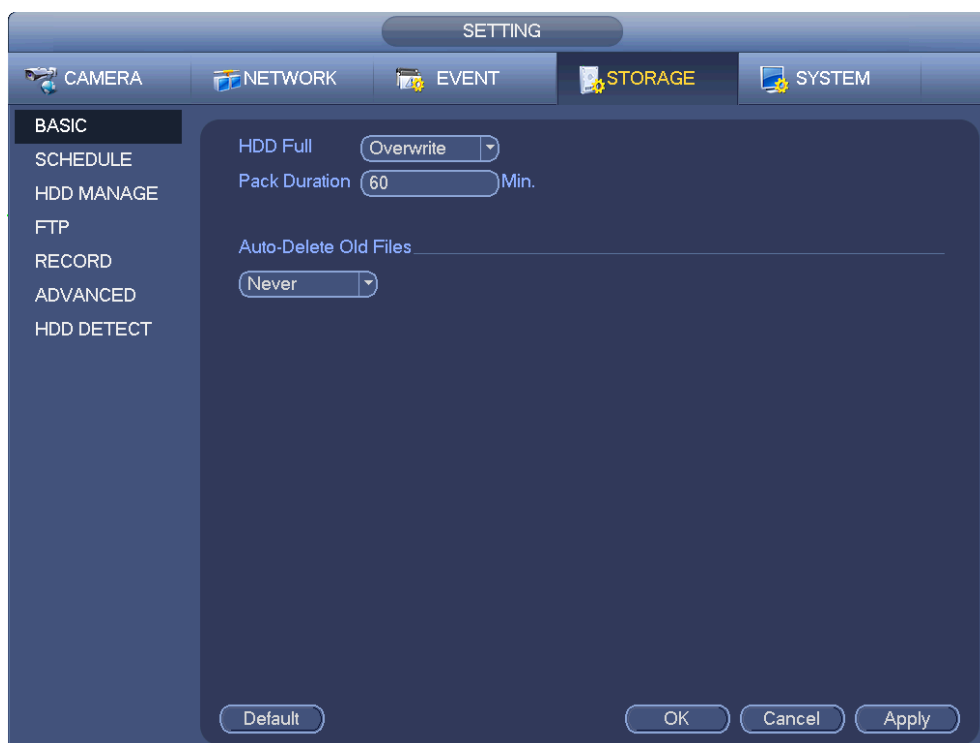

Figure 4-203

Step 2 Set parameters.

- HDD full: It is to select working mode when hard disk is full. There are two options: stop recording or rewrite.
- Pack duration: It is to specify record duration. The max length is 120 minutes.
- Auto delete old files:
  - ✧ Never: Do not auto delete old files.
  - ✧ Customized: input customized period here, system can auto delete corresponding old files.

Step 3 Click Apply or Save to complete setup.

## 4.9.2 Schedule

It is to set schedule record and schedule snapshot. NVR can record or snapshot as you specified. For detailed information, please refer to chapter 4.1.4.5.1 schedule record and 4.1.4.5.2 schedule snapshot.

## 4.9.3 HDD

It is to view and sett HDD properties and format HDD.

It is to view current HDD type, status, capacity and etc. The operation includes format HDD, and change HDD property (read and write/read-only/redundancy).

- To prevent files be overwritten in the future, you can set HDD as read-only.
- To backup recorded video file, you can set HDD as redundant HDD.

Step 1 From Mani-menu>Setting>Storage>HDD Manager, you can go to HDD management interface.  
See Figure 4-209.

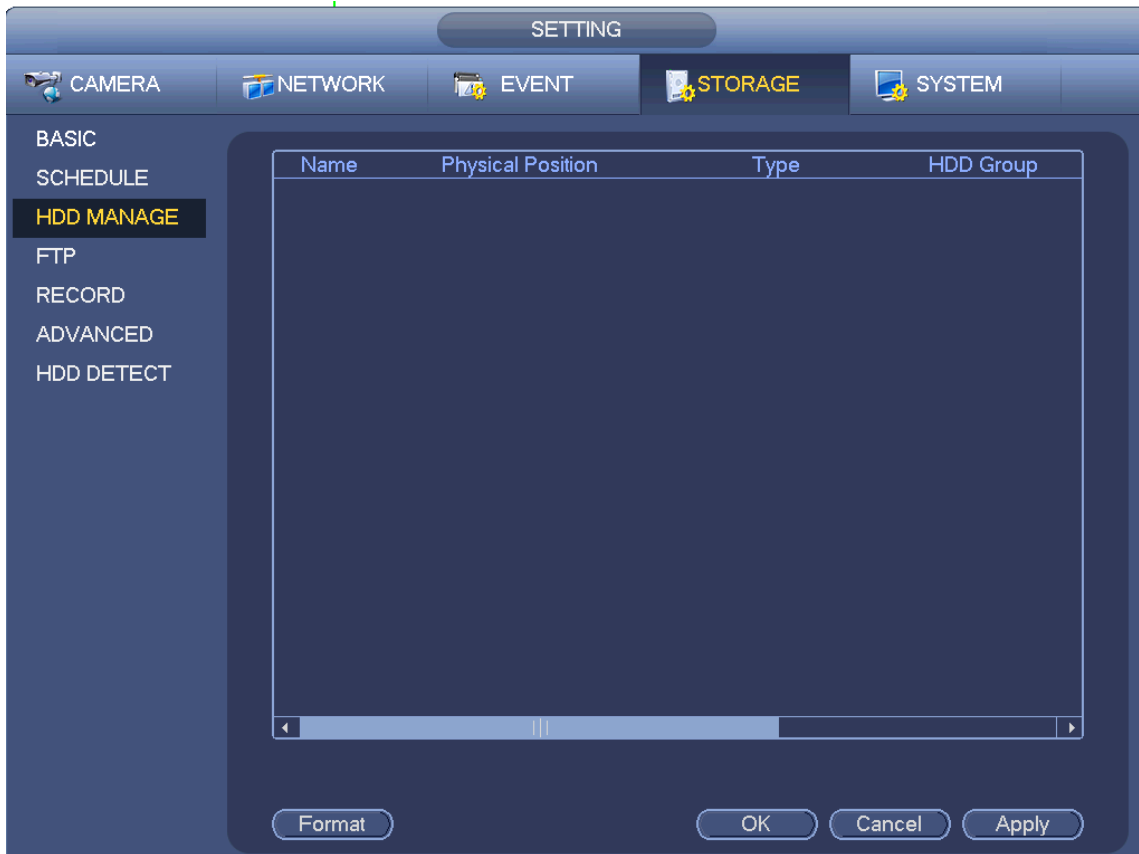

Figure 4-204

- Step 2 Select a HDD and then select an time from the dropdown list. Click Execute button.
- Step 3 Click OK button to complete the setup. You can see system needs to restart to activate current setup if you want to format the HDD.

## 4.9.4 FTP

It is to backup record file or image to the FTP to storage or view.

Before the operation, please download or purchase the FTP service tool and install on the PC.



### Note

For the FTP user, please set FTP folder write right, otherwise system cannot upload the image.

Step 1 From main menu>Setting>Storage>FTP, enter FTP interface. See Figure 4-210.

Step 2 Set parameters.

Here you can input FTP server address, port and remote directory. When remote directory is null, system automatically create folders according to the IP, time and channel.

- Host IP: The host IP you have installed the FTP server.
  - Host port: The default setup is 21.
  - User name/Password: The account for you to access the FTP server.
  - Remote directory: The folder you created under the root path of the FTP according to the corresponding rule.
- ✧ If there is no remote directory, system can auto create different directories according to the IP, time and channel.

- ✧ If there is remote directory, system can create corresponding folder under the FTP root path and then create different folders according to IP address, time and channel.
  - File length: File length is upload file length. When setup is larger than the actual file length, system will upload the whole file. When setup here is smaller than the actual file length, system only uploads the set length and auto ignore the left section. When interval value is 0, system uploads all corresponding files.
  - Image upload interval: It is the image upload interval. If the image upload interval is larger than the image snapshot frequency, system just uploads the lasted image.
    - ✧ If the image interval is 5 seconds and the snapshot frequency is 2 seconds, system will send out the latest image at the buffer at 5 seconds.
    - ✧ If the image upload interval is smaller than the snapshot frequency, system will upload at the snapshot frequency. For example, if the image interval is 5 seconds and the snapshot frequency is 10 seconds, system will send out the image at 10 seconds.
    - ✧ From main menu>Setting>Camera>Encode>Snapshot to set snapshot frequency.
  - Channel: Select a channel from the dropdown list and then set week, period and record type.
  - Week day/Period: Please select from the dropdown list and for each day, you can set two periods.
  - Type: Please select uploaded record type (Alarm/intelligent/motion detect/regular). Please check the box to select upload type.
- Step 3 Click the Test button, you can see the corresponding dialogue box to see the FTP connection is OK or not.
- Step 4 Click Apply or Save to complete setup.



Figure 4-205

## 4.9.5 Record Control

After you set schedule record or schedule snapshot function, please set auto record/snapshot function so that the NVR can automatically record or snapshot. For detailed information, please refer to chapter 4.1.4.5.3 record control.

## 4.9.6 HDD Information

Here is to list hard disk type, total space, free space, and status. See Figure 4-211.

○ means current HDD is normal.. - means there is no HDD.

If disk is damaged, system shows as “?”. Please remove the broken hard disk before you add a new one.

1*	Device Name	Type	Free Space/Total Space	Status	S.M.A.R.T
-		All	0.00 MB / 232.79 GB		
1*	SATA-1	Read/Write	0.00 MB / 232.79 GB	Normal	🔍

Figure 4-206

In Figure 4-211, click one HDD item, the S.M.A.R.T interface is shown as in Figure 4-212.

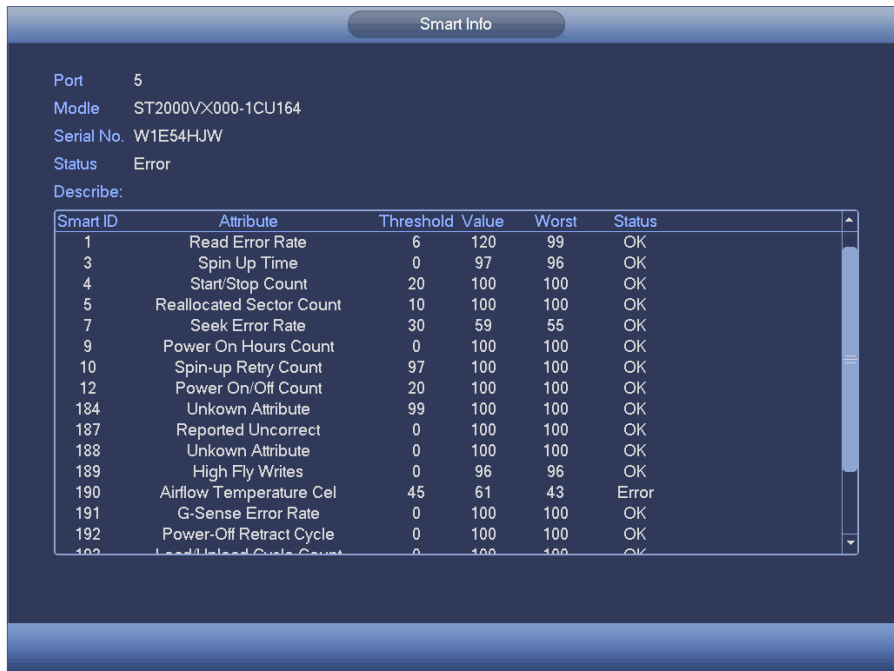

Figure 4-207

Parameter	Function
SATA	1 here means there is 1 HDD. For different series product, the max HDD amount may vary, When HDD is working properly, system is shown as O. . “_” means there is no HDD.
SN	You can view the HDD amount the device connected to; * means the second HDD is current working HDD.
Type	The corresponding HDD property.
Total space	The HDD total capacity.
Free space	The HDD free capacity.
Status	HDD can work properly or not.
Bad track	Display there is bad track or not.
Page up	Click it to view previous page.
Page down	Click it to view the next page.
View recording time	Click it to view HDD record information (file start time and end time).
View HDD type and capability	Click it to view HDD property, status and etc,

## 4.9.7 HDD Group

It is to set HDD group, and HDD group setup for main stream, sub stream and snapshot operation.



Caution

When you are setting HDD group, please set a HDD for each channel, otherwise NVR cannot save current setup.

The main stream is shown as in Figure 4-213.

- HDD: Here you can view the HDD amount the device can support.
- Group: It lists the HDD Group number of current hard disk.



Figure 4-208

Please select the correspond group from the dropdown list and then click Apply button. Click sub stream/snapshot button to set corresponding HDD group information.

## 4.9.8 HDD Detect



Note

This function is for some series product only.

The HDD detect function is to detect HDD current status so that you can clearly understand the HDD performance and replace the malfunction HDD.

There are two detect types:

- Quick detect is to detect via the universal system files. System can quickly complete the HDD scan. If you want to use this function, please make sure the HDD is in use now. If the HDD is



removed from other device, please make sure the write-data once was full after it installed on current device.

- Global detect adopts Windows mode to scan. It may take a long time and may affect the HDD that is recording.

### 4.9.8.1 Manual Detect

From main menu>Setting>Storage>HDD Detect>Manual Detect, the interface is shown as below. See Figure 4-214.

Please select detect type and HDD. Click start detect to begin. You can view the corresponding detect information.

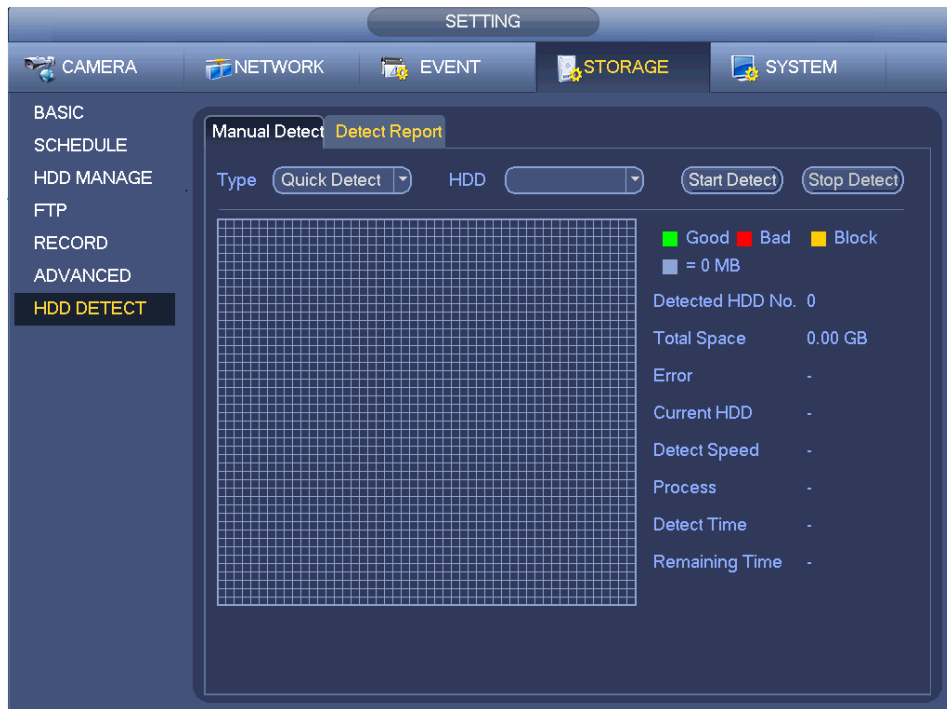

Figure 4-209

### 4.9.8.2 Detect Report

After the detect operation, you can go to the detect report to view corresponding information.

From main menu>Setting>Storage>HDD Detect>Manual Detect, the interface is shown as below. See Figure 4-215.

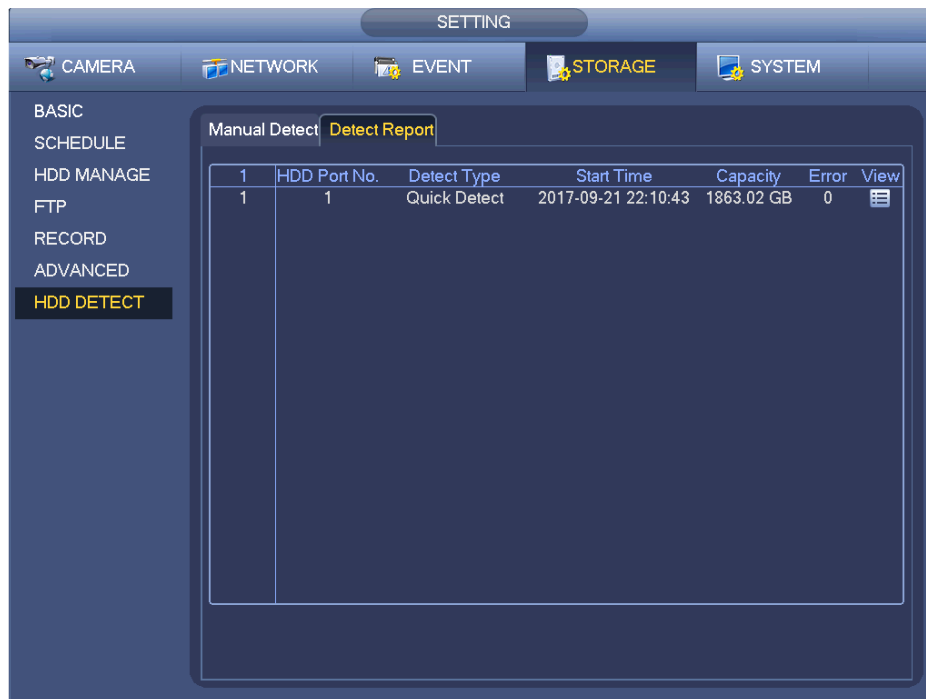

Figure 4-210

Click View, you can see the detailed information such as detect result, backup and S.M.A.R.T. See Figure 4-216 and Figure 4-217.

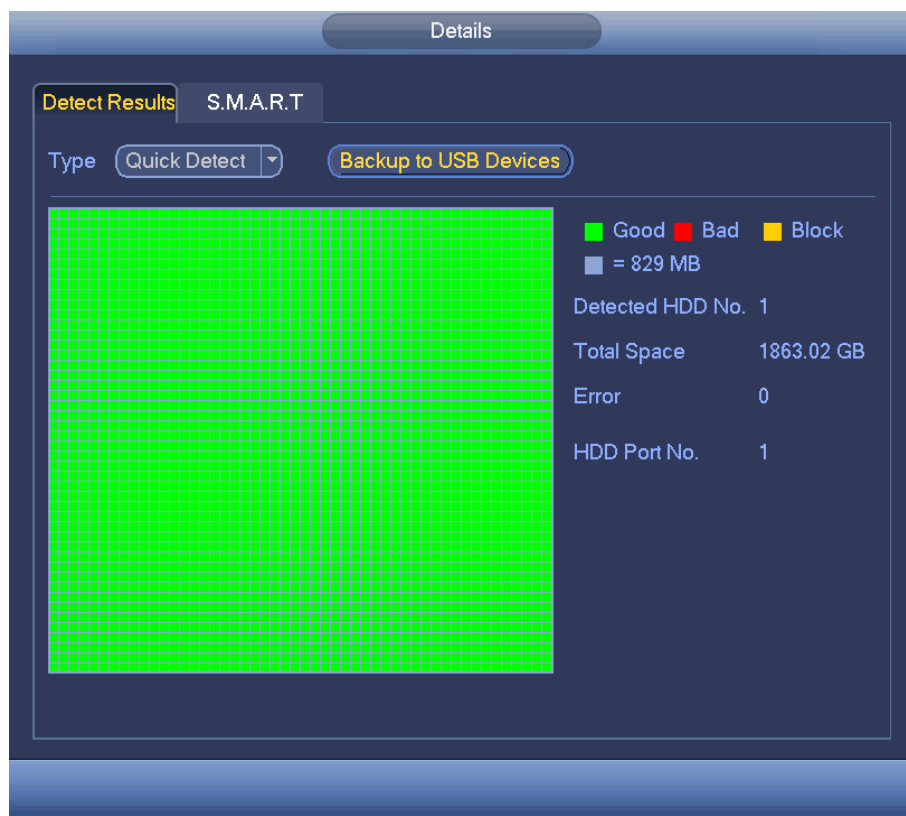

Figure 4-211

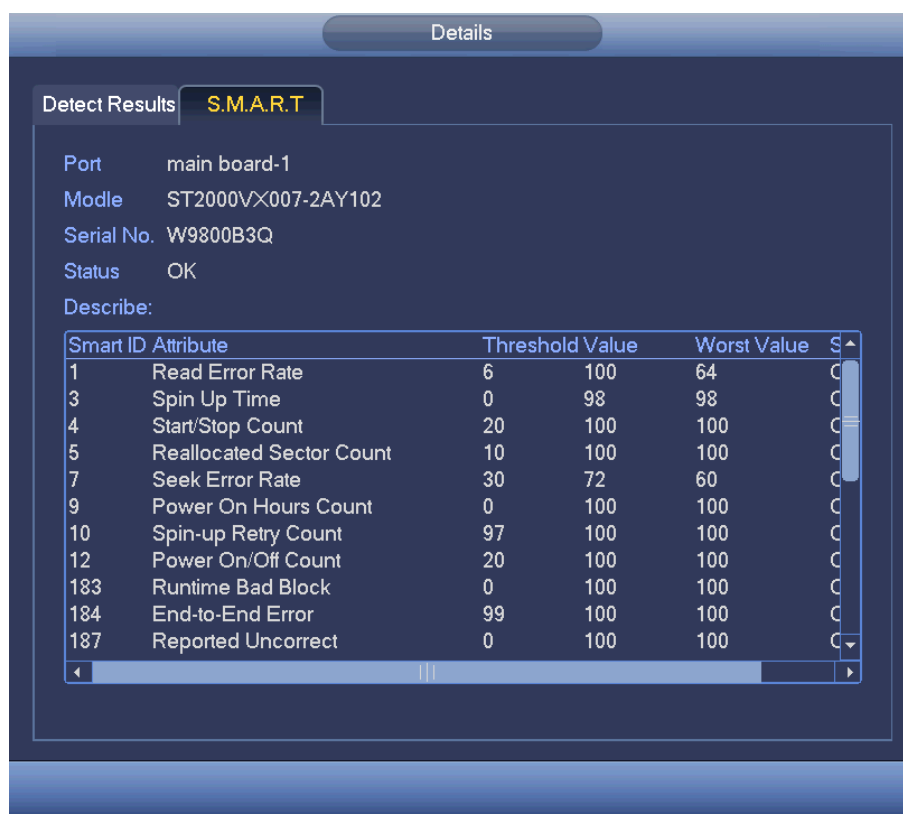

Figure 4-212

## 4.9.9 RAID Manager

RAID (redundant array of independent disks) is a data storage virtualization technology that combines multiple physical HDD components into a single logical unit for the purposes of data redundancy, performance improvement, or both.



### Note

- RAID function is for some series product only. Slight difference may be found on the user interface.
- Right now, NVR supports RAID0, RAID1, RAID5, RAID6, and RAID 10. Local hotspare supports RAID1, RAID5, RAID6, and RAID10.
- Refer to the following table for detailed information.

RAID Type	HDD Amount
RAID0	At least 2 HDDs.
RAID1	Only 2 HDDs.
RAID5	At least 3 HDDs. Usually recommend the RAID5 consists of 4 to 6 HDDs.
RAID6	At least 4 HDDs.
RAID10	At least 4 HDDs.

## 4.9.9.1 RAID Config

It is for you to manage RAID HDD. It can display RAID name, type, free space, total space, status and etc. Here you can add/delete RAID HDD.

Click Add button to select RAID type and then select HDDs, click OK button to add. See Figure 4-218.

### One click to create RAID

- Click it to automatically create RAID5.
- For create RAID function, you can select the physical HDD that does not included in the RAID group or the created disk array to create a RAID5. You can refer to the following situations:
- There is no RAID, no hotspare disk: System directly creates the RAID5 and creates one hotspare disk at the same time.
- There is no RAID, but there is a hotspare disk: System creates the RAID5 only. It uses previous hotspare disk.
- There is RAID: System cancel the previous RAID setup and then create the new RAID5. System creates the hotspare disk if there is no one. System uses previous hotspare disk if there is hotspare disk available.
- The background will format the virtual disk.

### Create manually

Step 1 Select RAID type first and then follow the prompts to set HDD amount.

Step 2 Click Create Manually button, system pops up dialogue box to warning you it is going to clear all data.

Step 3 Click OK button to complete the operation.



### Note

Click  to delete RAID.

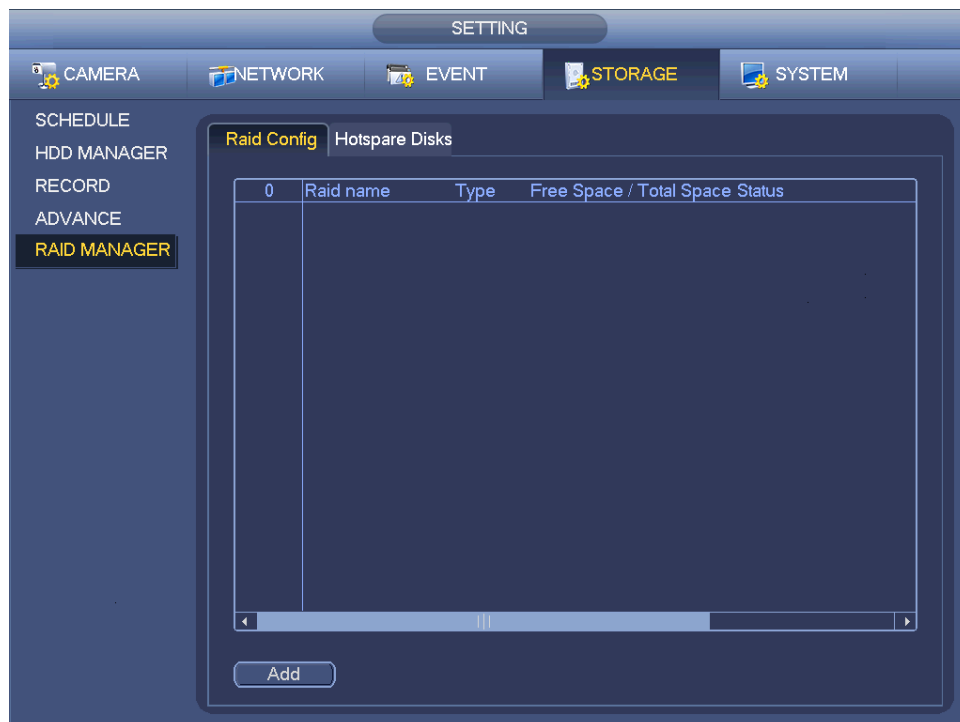

Figure 4-213

## 4.9.9.2 Hotspare disks

When a HDD of the RAID group is malfunction or abnormal, the hotspare HDD can replace the malfunction or abnormal HDD in case there is any data loss. It is to guarantee storage system reliability. Click Hotspare disks tab name, you can add the hot spare HDD. See Figure 4-219. The type includes two options:

- Global: It is global hotspare disk. When any RAID becomes degrading, it can replace and build the RAID.
- Local: It is local hotspare disk. When the specified RAID becomes degrading, it can replace and build the RAID.

Select a hot spare device and then click Delete button. Click Apply button to delete.

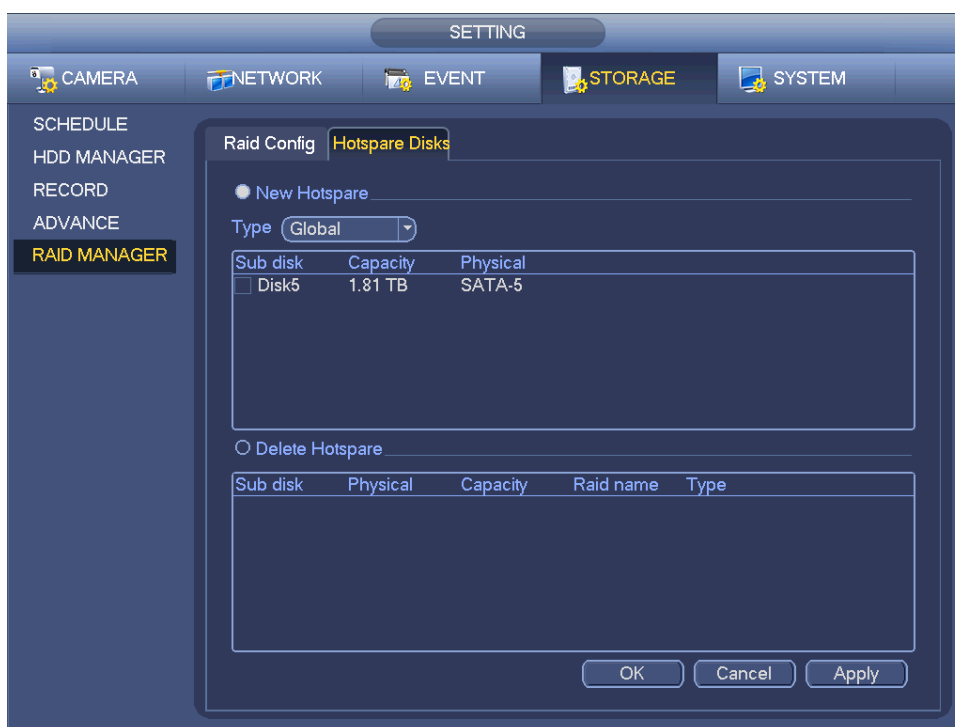

Figure 4-214

## 4.10 Device Maintenance and Manager

### 4.10.1 Account

It is to manage users, user group and ONVIF user, set admin security questions.



#### Note

- For the user name, the string max length is 31-byte, and for the user group, the string max length is 15-byte. The user name can only contain English letters, numbers and “\_”、“@”、“.”.

- The default user amount is 64 and the default group amount is 20. System account adopts two-level management: group and user. The user authorities shall be smaller than group authorities (The **admin** user authorities are set by default).
- For group or user management, there are two levels: admin and user. The user name shall be unique and one user shall only belong to one group.

## 4.10.1.1 User

### 4.10.1.1.1 Add User

Step 1 From main menu>Setting>System>Account>User.  
Enter user interface. See Figure 4-220.

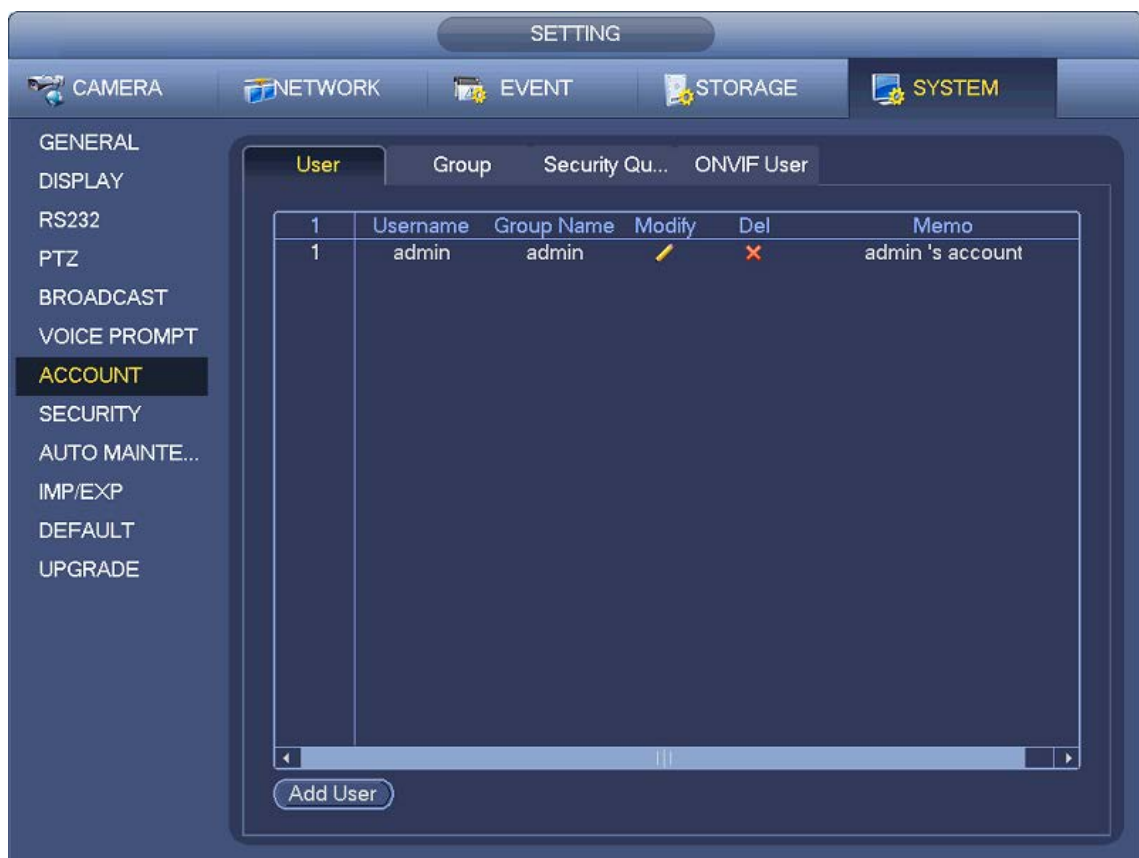

Figure 4-215

Step 2 Click Add user button in Figure 4-220.  
The interface is shown as in Figure 4-221.

Figure 4-216

Step 3 Input the user name, password, select the group it belongs to from the dropdown list. Then you can check the corresponding rights for current user.



**Note**

For convenient user management, usually we recommend the general user right is lower than the admin account.

Step 4 Click the Set button after the period, you can set valid period to use current account. See Figure 4-222.

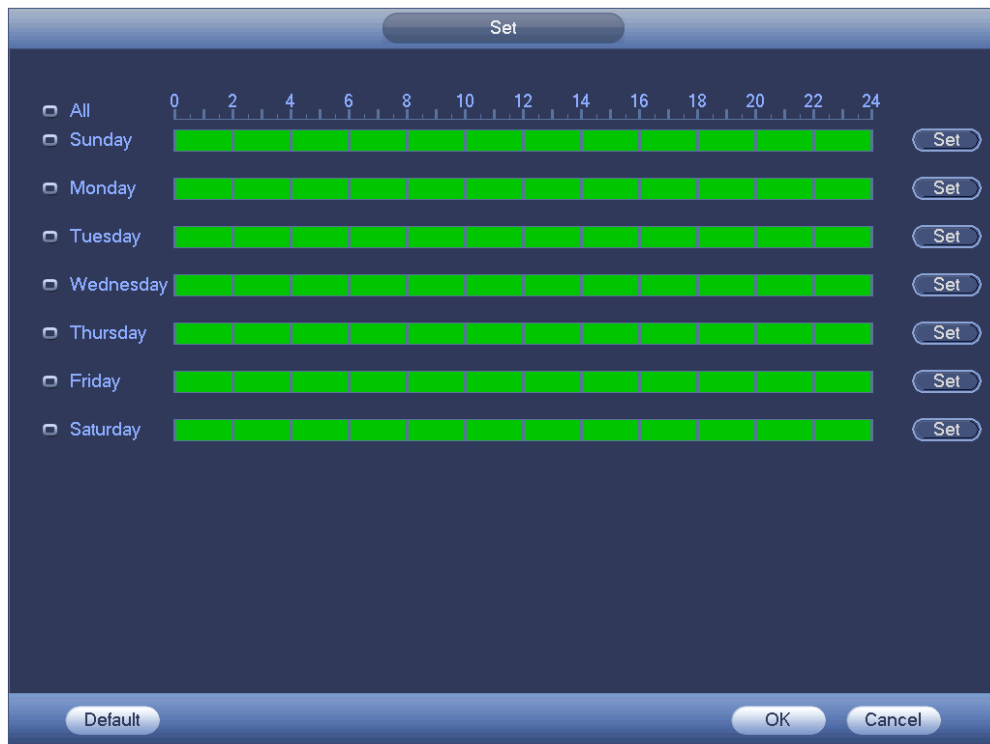

Figure 4-217

- Step 5 Click Set button, you can set six periods in one day. See Figure 4-223.
- Step 6 Check the box after the period, you can enable current setup.

 **Note**

Check the box before the week; it is to save period settings to selected week day.



Figure 4-218



Step 7 Click OK button.

#### 4.10.1.1.2 Modify user

From main menu>Setting>System>Account>User, click , you can go to the following interface to change user information. See Figure 4-224.



Figure 4-219

For **admin** user, you can change the email, enable/disable unlock pattern, change password prompt question, set security questions. See Figure 4-225.



Figure 4-220

- Input email information and then click Save, it is to set/change email address.
- Check the box to enable unlock pattern and then click , click Save to change unlock pattern.
- Set security question

Step 1 Click Security question, enter the following interface. See Figure 4-226.

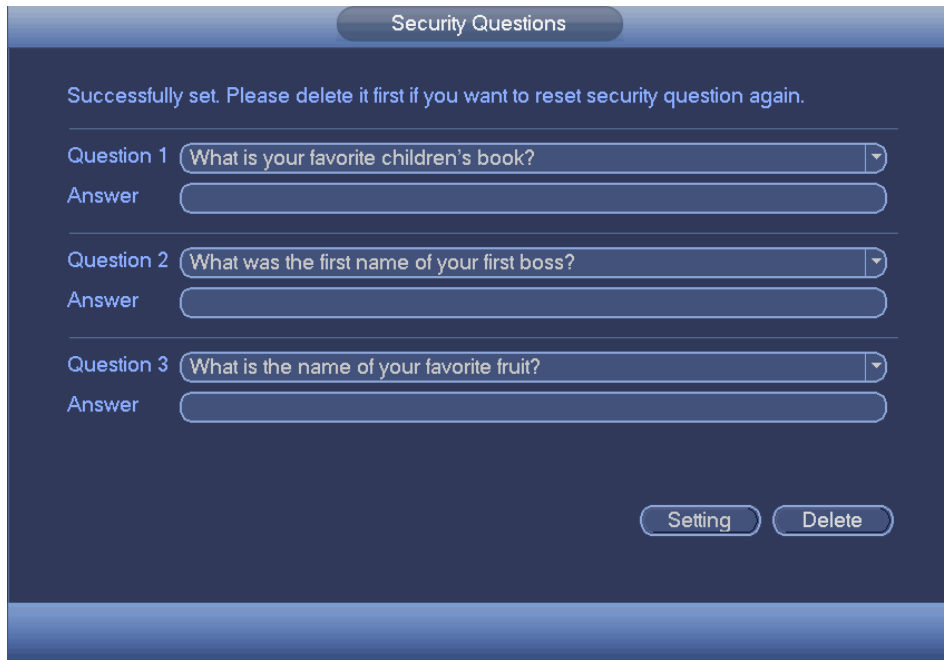

Figure 4-221

Step 2 Input answers and then click Save button.

After successfully set security questions, you can answer the security questions to reset admin password.

 **Note**

Select security questions from the dropdown list and then input the proper answers, click Delete button to reset security questions and answers again.

#### 4.10.1.1.3 Change Password

In Figure 4-224, check the Modify password box, you can change password. Please input old password, and then input new password twice to confirm.

- Password/confirm password: The password ranges from 8 to 32 digitals. It can contain letters, numbers and special characters (excluding “”, “'”, “,”, “.”, “&”) . The password shall contain at least two categories. Usually we recommend the strong password.

 **CAUTION**

**STRONG PASSWORD RECOMMENDED**-For your device own safety, please create a strong password of your own choosing. We also recommend you change your password periodically especially in the high security system.

## 4.10.1.2 Modify Group

Step 1 From main menu>Setting>System>Account>Group.  
Enter add group interface. See Figure 4-227.



Figure 4-222

Step 2 Click add group button in Figure 4-227.

Enter Add group the interface. See Figure 4-228.

Step 3 Input group name and then input some memo information if necessary. Check the box to select authorities.



Figure 4-223

### 4.10.1.3 Security Question

 **Note**

This function is for **admin** user only.

Here you can change security questions. After you successfully answered security questions, you can reset admin account password.

From main menu>Setting>System>Account>Security question, the interface is shown as below. See Figure 4-229. Input correct security answers and then click Delete button at the bottom of the interface, you can reset security questions and answers.

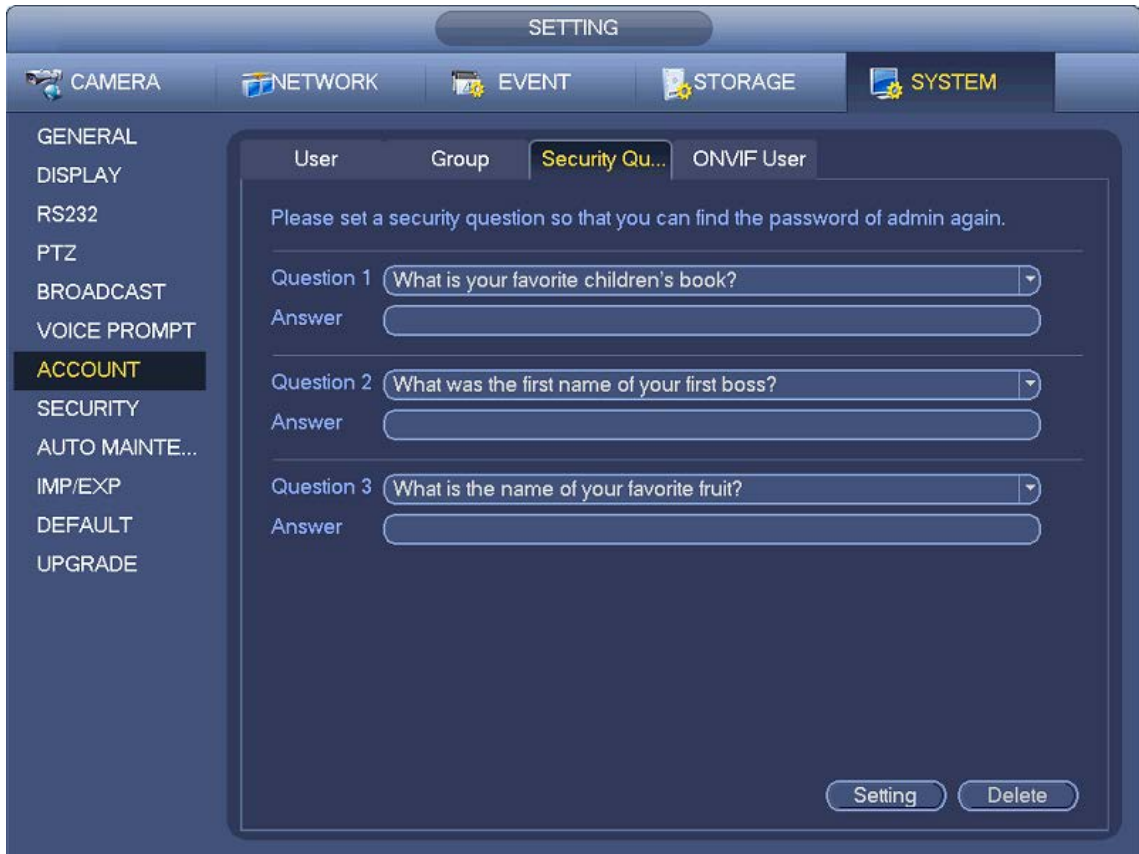

Figure 4-224

#### 4.10.1.4 ONVIF User

When the camera from the third party is connected with the DVR via the ONVIF user, please use the verified ONVIF account to connect to the DVR. Here you can add/delete/modify user

 **Note**

The default ONVIF user is **admin**. It is created after you initialize the DVR.

- Step 1 From main menu>Setting>System>Account>ONVIF User.  
Enter ONVIF interface. See Figure 4-230.

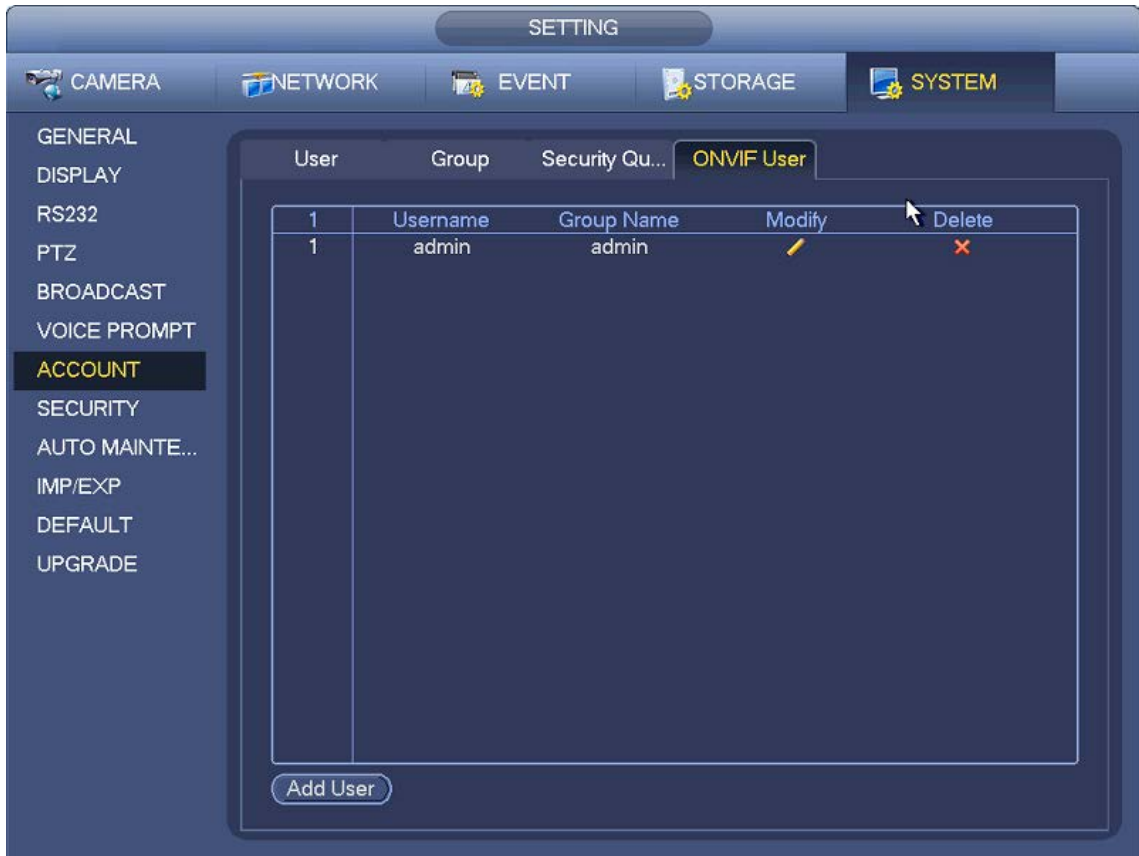

Figure 4-225

- Step 2 Click Add User button.  
 Enter Add User interface. See the following figure.



Figure 4-226

- Step 3 Set user name, password and then select group from the dropdown list.  
 Step 4 Click Save to complete setup.

 **Note**

Click  to change user information, click  to delete current user.

### 4.10.1.5 Online User

Here is for you manage online users connected to your NVR. See Figure 4-232.

You can click button  to disconnect or block one user if you have proper system right.

System detects there is any newly added or deleted user in each five seconds and refresh the list automatically.

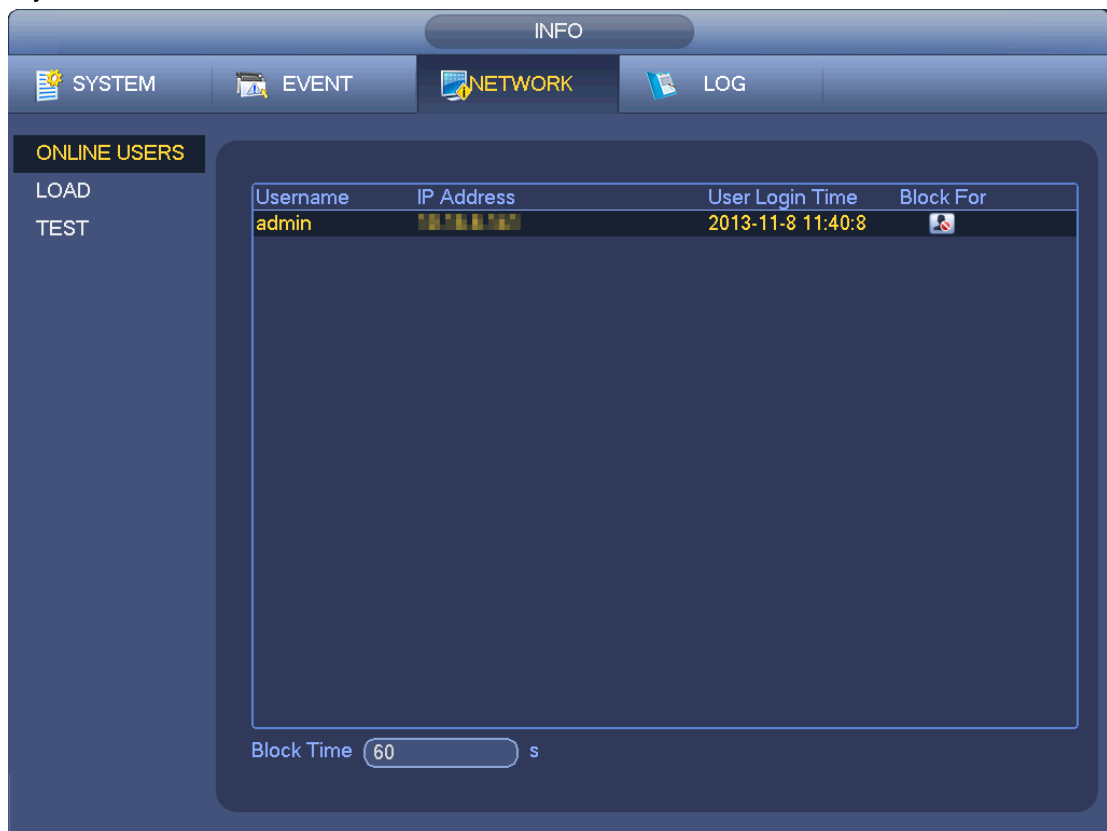

Figure 4-227

## 4.10.2 System Info

### 4.10.2.1 Version

From main menu>Info>System>version, you can go to version interface.

It is to view NVR version information. Slight different may be found on the user interface.

### 4.10.2.2 BPS

Here is for you to view current video bit rate (kb/s) and resolution. See Figure 4-233.

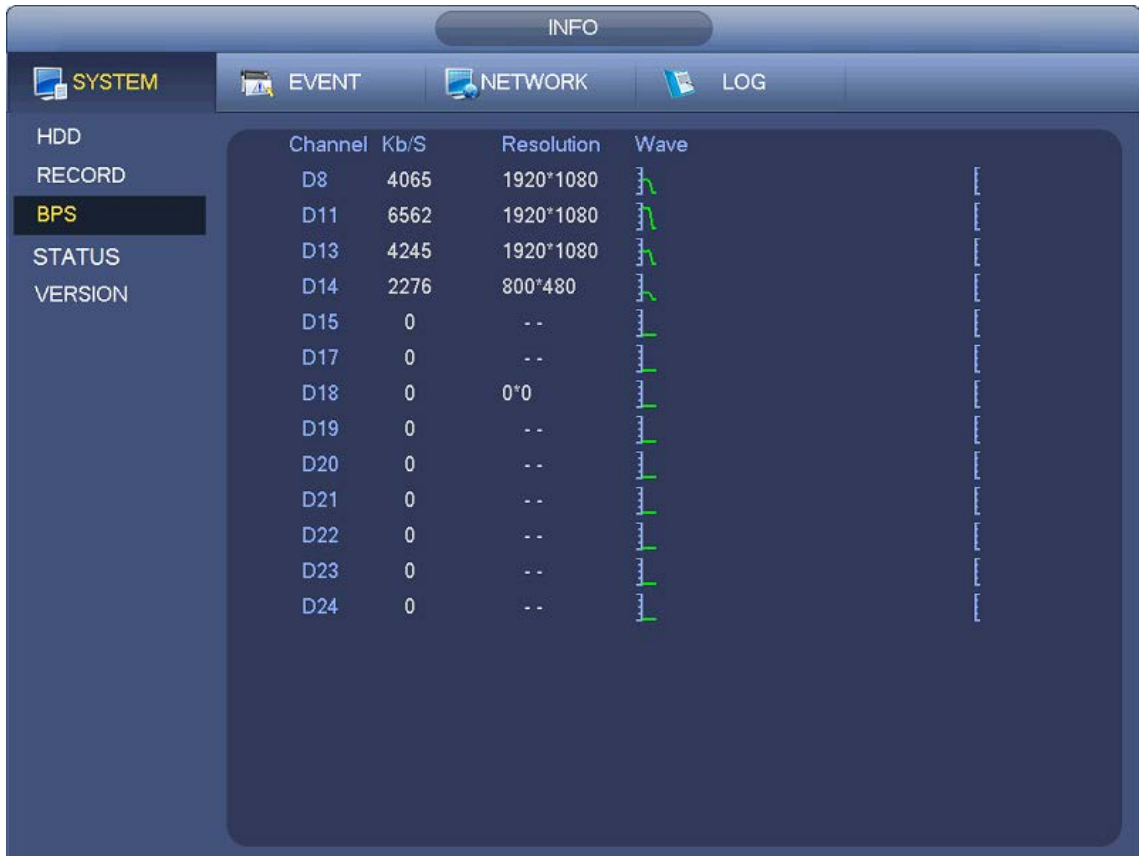

Figure 4-228

### 4.10.2.3 Event Information

#### 4.10.2.3.1 Alarm Status

From main menu>info>Event, here you can view the channel status of the remote device, connection log and etc. See Figure 4-234.





Figure 4-229

#### 4.10.2.3.2 People Counting

This function allows system to detect the people flow amount in the specified zone and display the people amount statistics image.

From main menu>Info>Event>People Counting, you can go to the following interface. See Figure 4-235.

Channel: Please select a channel from the dropdown list.

- Type: Please select report type from the dropdown list. It includes daily report/monthly report/annual report. You can click to select histogram or polygon chart.
- Start time/end time: Input start time and end time of the people counting.
- Enter: Check to search enter amount.
- Exit: Check the box to search exit amount.
- Display No.: Check the box, system can display enter and exit people amount in the report.



Figure 4-230

#### 4.10.2.3.3 Heat Map

It is to search and view the heat map of each channel.

From main menu>Info>Event>Heat Map, you can go to the following interface. See Figure 4-236.

Select a channel, input start time and end time. Please note the report search period shall be within one month.

Click Search button, you can view the heat map report.



Figure 4-231

## 4.10.3 Voice

The audio function is to manage audio files and set schedule play function. It is to realize audio broadcast activation function.

### Note

This function is for some series product only.

#### 4.10.3.1.1 File Manage

Here you can add audio file, listen to the audio file, or rename/delete audio file. Here you can also set audio volume. See Figure 4-237.

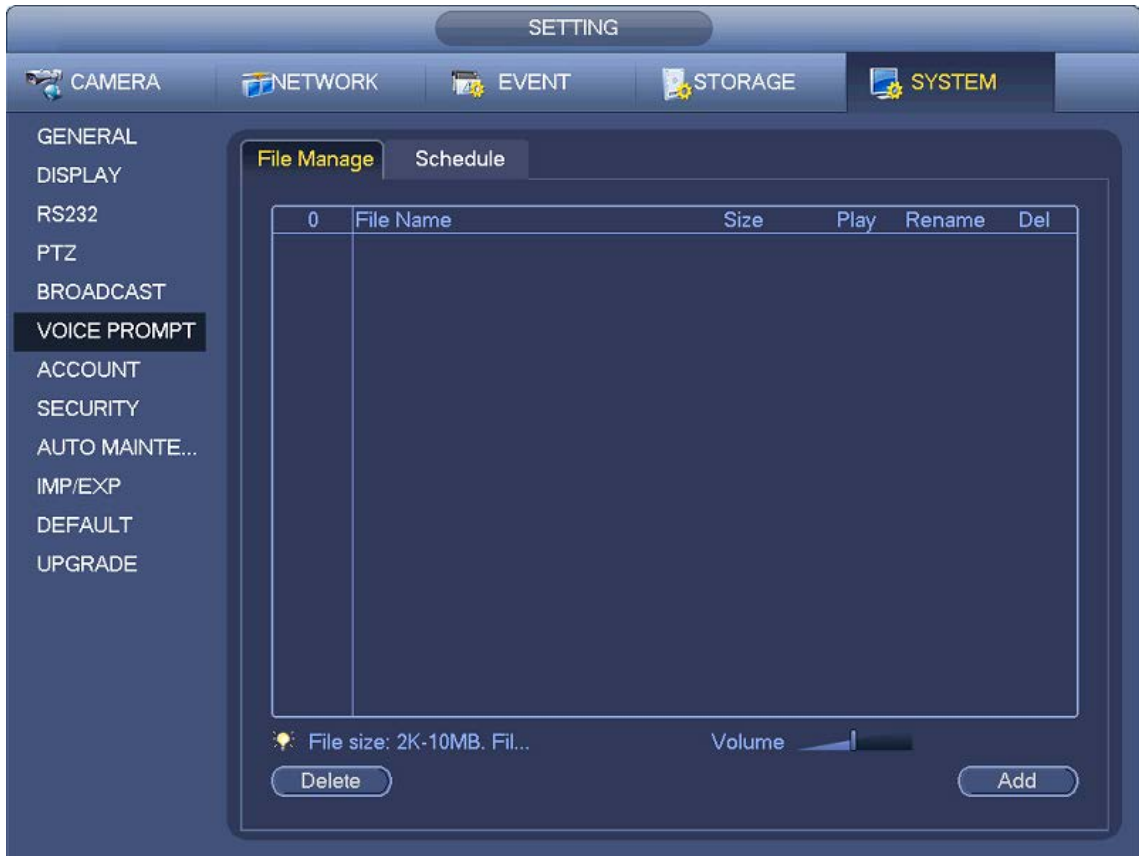

Figure 4-232

Click Add button, you can add audio file and import the audio file via the USB device. The audio file format shall be MP3 or PCM. See Figure 4-238.

 **Note**

The file size shall be 2K-10MB.



Figure 4-233

#### 4.10.3.1.2 Schedule

It is to set schedule broadcast function. You can play the different audio files in the specified periods. See Figure 4-239.



Figure 4-234

#### 4.10.4 RS232

After setting RS232 parameters, the NVR can use the COM port to connect to other device to debug and operate.

From Main menu>Setting>System>RS232, RS232 interface is shown as below. There are five items. See Figure 4-240.

- Function: There are various devices for you to select.
  - ✧ Console is for you to use the COM or mini-end software to upgrade or debug the program.
  - ✧ Control keyboard is for you to control the device via the special keyboard.
  - ✧ Transparent COM (adapter) is to connect to the PC to transfer data directly.
  - ✧ Protocol COM is for card overlay function.
  - ✧ Network keyboard is for you to use the special keyboard to control the device.
  - ✧ PTZ matrix is to connect to the peripheral matrix control.

 **Note**

Different series products support different RS232 functions. Please refer to the actual product for detailed information.

- Baud rate: You can select proper baud rate.
- Data bit: You can select proper data bit. The value ranges from 5 to 8.
- Stop bit: There are three values: 1/1.5/2.
- Parity: there are five choices: none/odd/even/space mark.

System default setup is:

- Function: Console

- Baud rate:115200
- Data bit:8
- Stop bit:1
- Parity: None

After completing all the setups please click save button, system goes back to the previous menu.

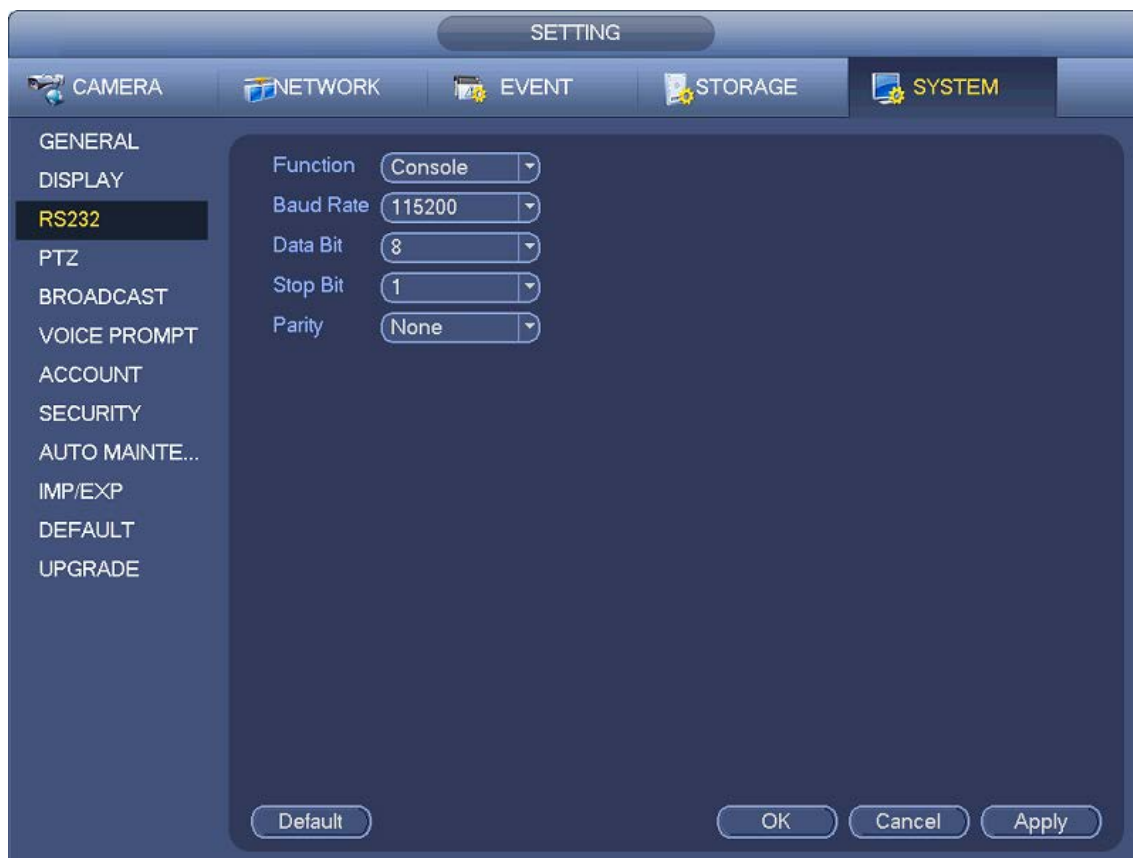

Figure 4-235

## 4.10.5 Broadcast

It is to broadcast to the camera, or broadcast to a channel group.

Step 1 From Mani menu>Setting>System>Broadcast.

Enter the following interface. See Figure 4-241.

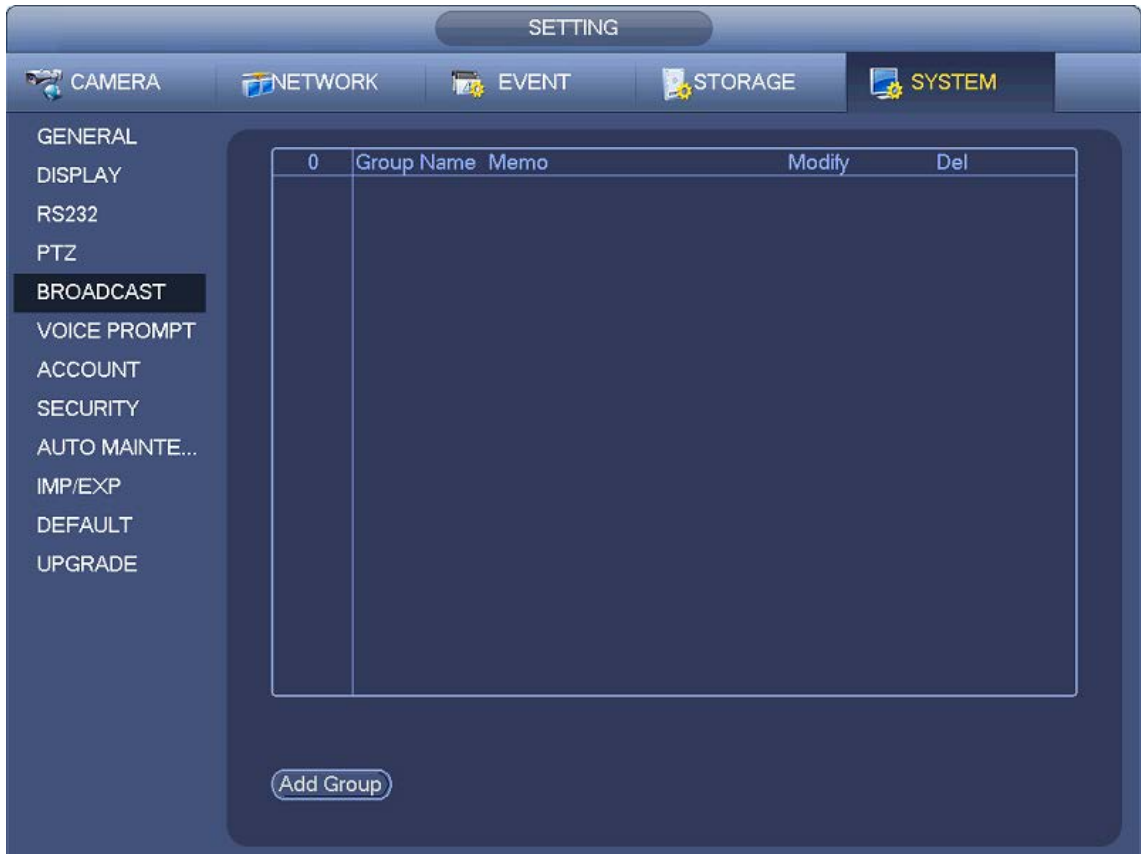

Figure 4-236

- Step 2 Click Add group.  
 Enter add group interface. See Figure 4-242.







Figure 4-237

- Step 3 Input group name and select one or more channels.  
 Step 4 Click Save button to complete broadcast group setup.



 **Note**

On the broadcast interface, click  to change group setup, click  to delete group.

After complete broadcast setup, on the preview interface and then click  on the navigation bar, device pops up broadcast dialogue box. Select a group name and then click  to begin broadcast. See Figure 4-243.

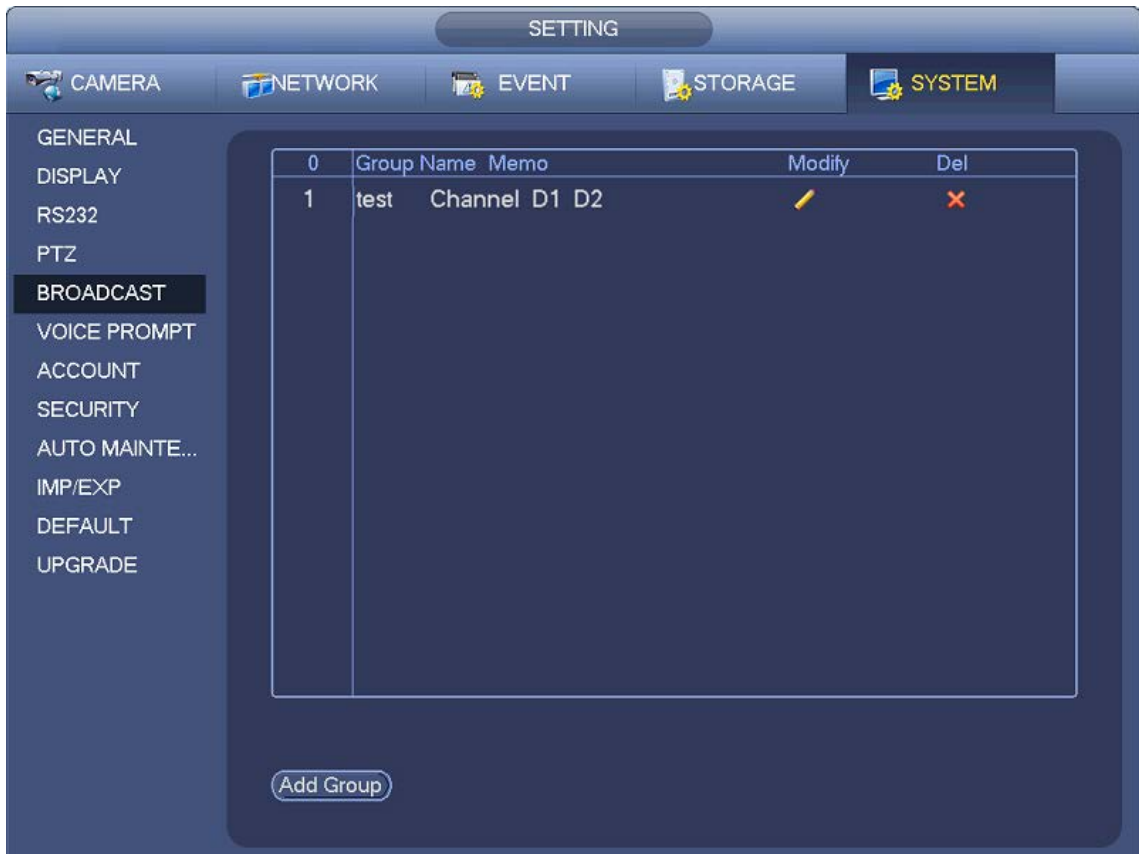

Figure 4-238

## 4.10.6 Security

### 4.10.6.1 IP Filter

Set the IP host (refers to the device with an IP address) that accesses the NVR device. After the configuration is complete, only the IP host in the trusted list can successfully log in to the web interface. The IP host in the blocked list cannot log in to the web interface, thus enhancing the network and data security of the NVR device.

Select the Enable check box and select Trusted Sites or Blocked Sites. The system supports up to 64 IPs.

- When Trusted Sites is selected, it means that only the IP in the list can access this device.
- When the Blocked Sites is selected, the IP in the list cannot access the device.

 **Note**

The device supports to enter IPv4 address and IPv6 address. Enter the IPv6 address format and the device will check the validity and optimize the format.

Step 1 Enter from main menu > Setting > System > Security > IP Filter.

The IP Filter interface is displayed. See Figure 4-244.

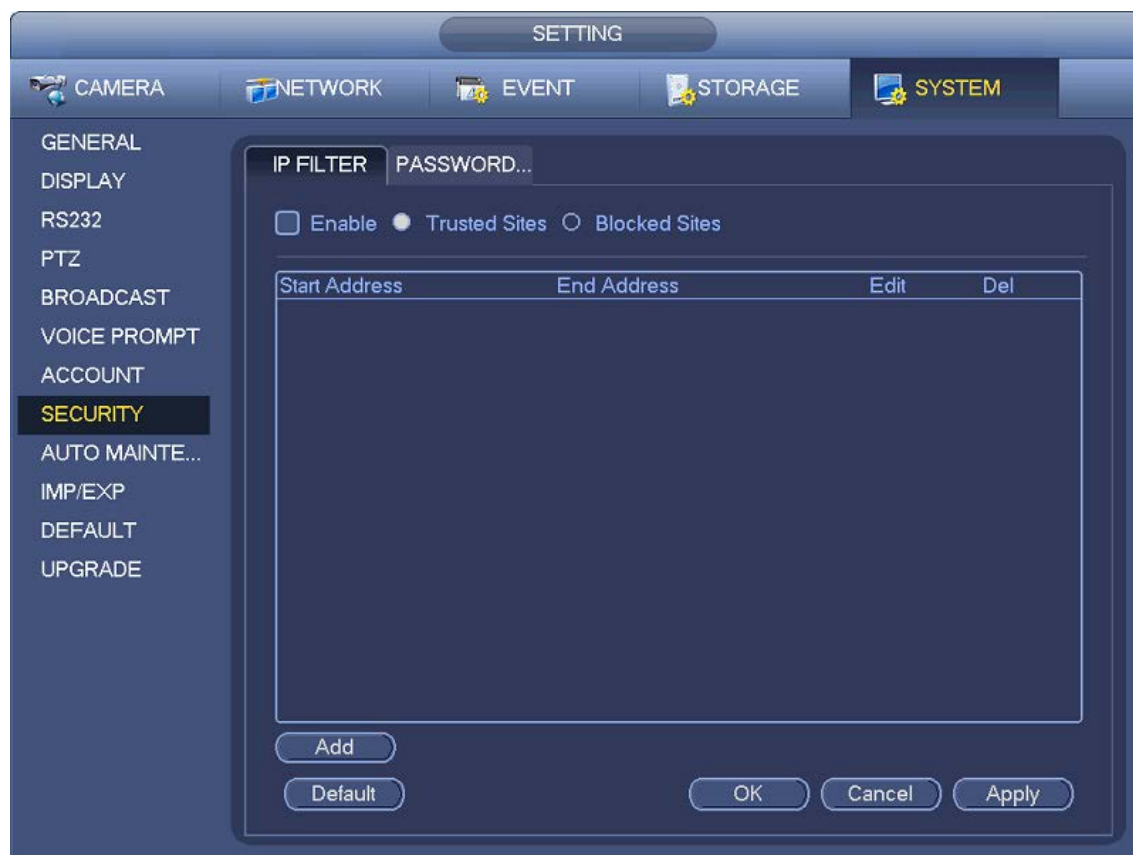

Figure 4-239

Step 2 Select the Enable check box.

- Click Trusted Sites to add trusted sites.

1. Click Add.

In the popped up dialogue box, configure the IP address according to the notes in the following table. System supports to configure 64 IP addresses at most.

Parameter	Description
IP Address	Enter the IP address of the host you want to add. It support IPv4 and IPv6. <ul style="list-style-type: none"> <li>● IPv4: Format example is 192.168.5.10.</li> <li>● IPv6: Format example is aa:aa:aa:aa:aa:aa:aa:aa.</li> </ul>
IP Segment	<ul style="list-style-type: none"> <li>● Enter the start address and end address of the IP segment you want to add.</li> </ul>
MAC Address	<ul style="list-style-type: none"> <li>● Enter the MAC address of the host you want to add.</li> </ul>

2. Click OK to Apply to activate the configuration.

You can use the IP address in the trusted sutes list to log in the Web interface.

- Click Blocked Sites to add blocked sites.

1. The system does not support to add blocked sites via the MAC address.

2. Click OK to Apply to activate the configuration.

Use the IP host in the blocked list to log in to the device WEB interface. The system prompts that it has been blocked and cannot log in.

Step 3 Click Apply or OK to complete the setting.

## 4.10.6.2 Password Reset



### NOTE

- Password reset is open by default. If you forget the admin login password, click Forgot Password to reset it. For detailed operations, please refer to chapter 4.1.3 Reset Password.
- If password reset is closed, you will not be able to retrieve password by email. The only choice is to use the security questions. If security question is not set, the system directly prompts that “Password reset is closed.”

Please follow the below steps to close the password reset function.

Step1 From main menu>Setting>System>Security >Password Reset.

The Password Reset interface is displayed. The password reset function is enabled by default. See Figure 4-245.

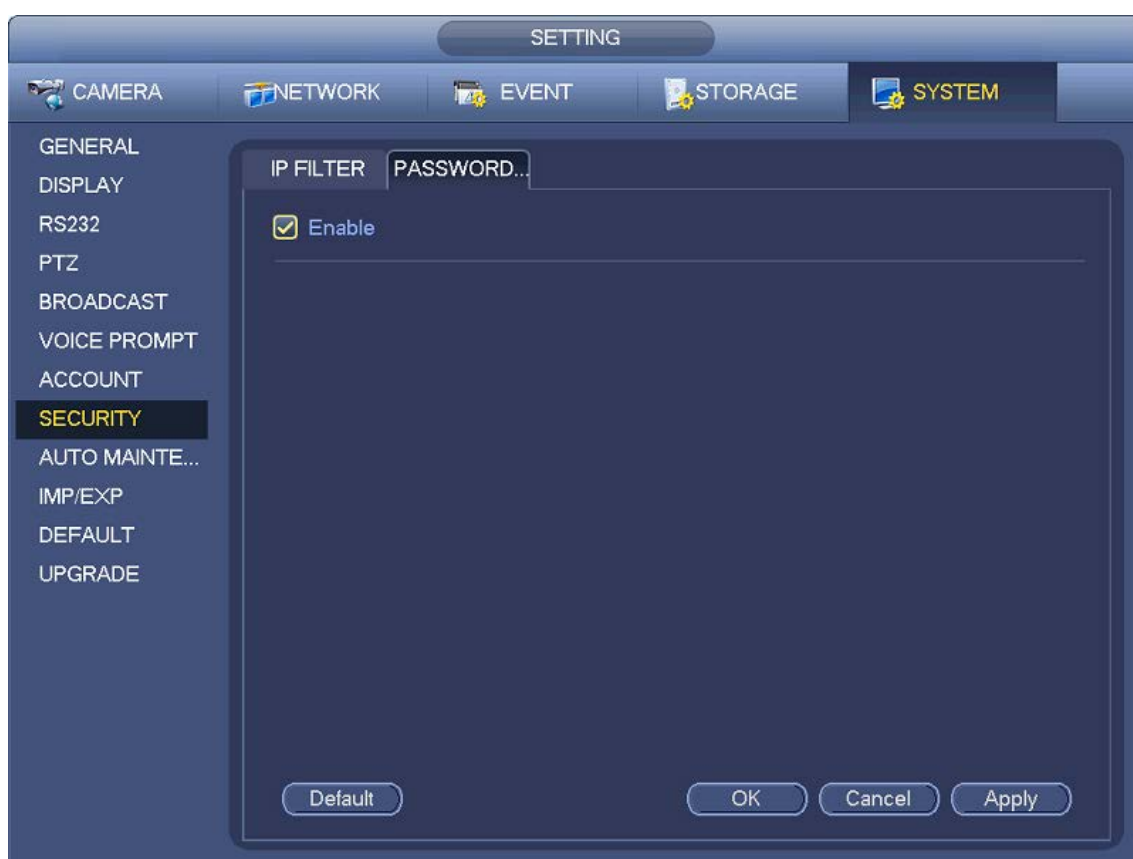

Figure 4-240

Step2 Click  to cancel enabling.

Step3 Click OK or Apply.

A Prompt pops up. See Figure 4-246.

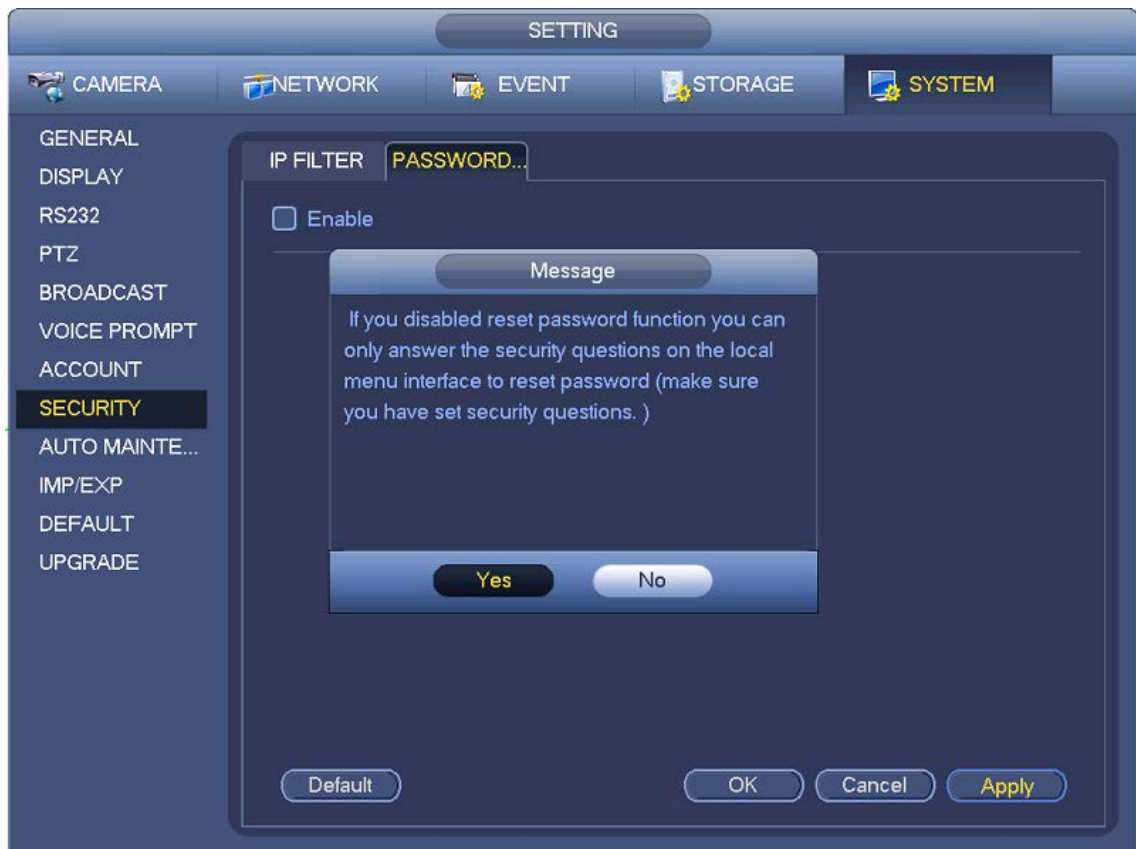

Figure 4-241

Step4 Click Yes.

Step5 Click OK to complete the configuration.

### 4.10.7 Auto Maintain

When the device runs for a long time, you can set the device to restart automatically during idle time to improve the device speed.

Step 1 Enter from main menu > Setting > System > Auto Maintenance.

The Auto Maintenance interface is displayed. See Figure 4-247.

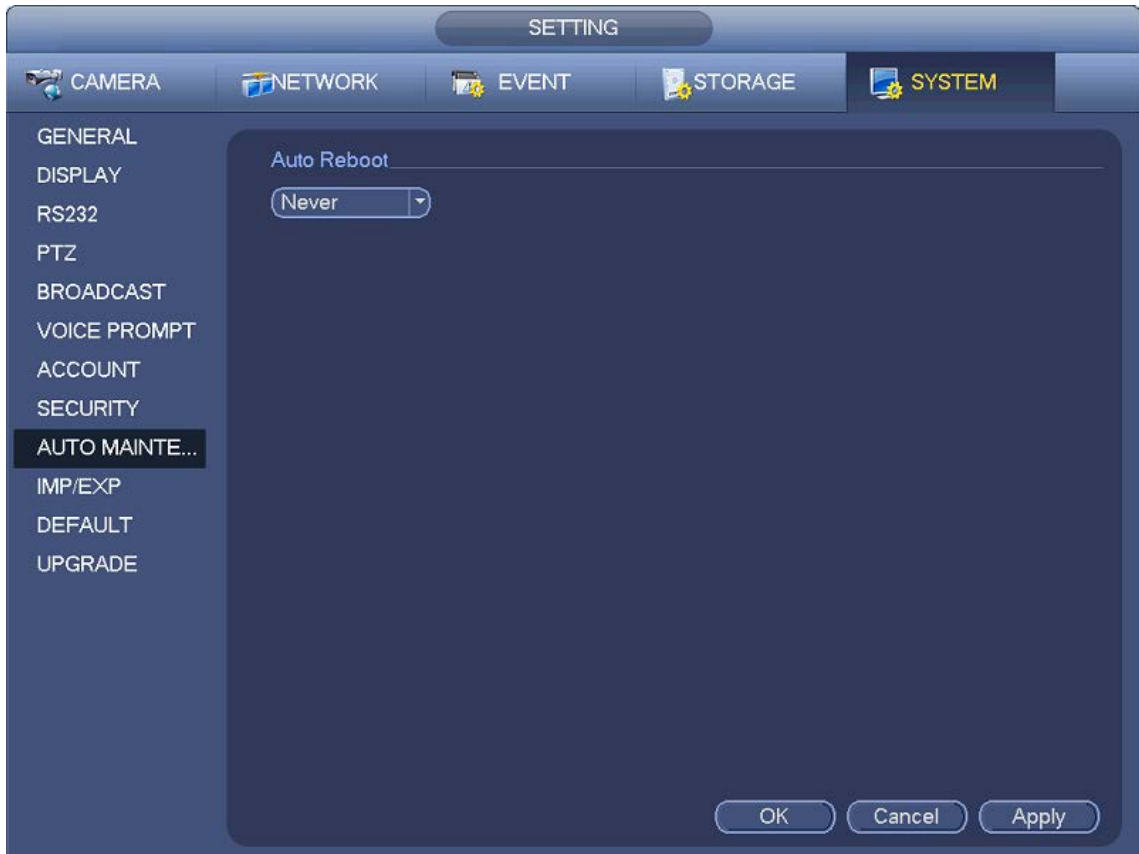

Figure 4-242

- Step 2 In the Auto Reboot drop-down list, select the time to auto reboot the system.
- Step 3 Click Apply or OK to complete the setting.

## 4.10.8 Backup

### 4.10.8.1 File Backup

In this interface, you can backup record file to the USB device.

- a) Connect USB burner, USB device or portable HDD and etc to the device.
- b) From Main menu>Backup, you can go to the Backup interface. See Figure 4-248

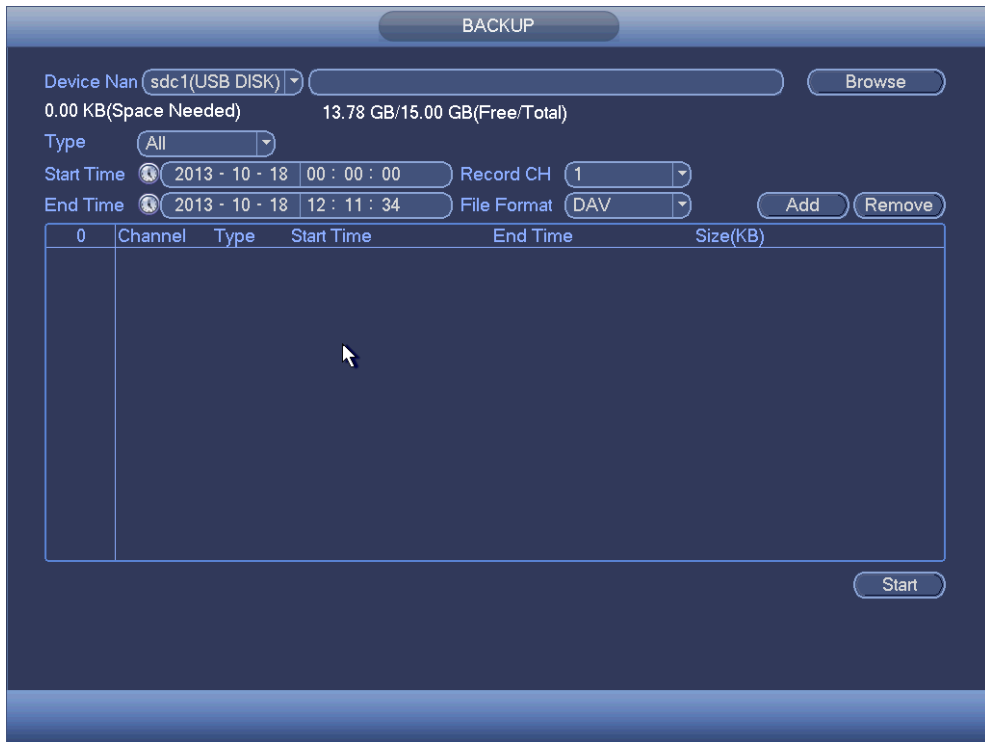

Figure 4-243

- c) Select backup device and then set channel, file start time and end time.
- d) Click add button, system begins search. All matched files are listed below. System automatically calculates the capacity needed and remained. See Figure 4-249.
- e) System only backup files with a  before channel name. You can use Fn or cancel button to delete  after file serial number.
- f) Click backup button, you can backup selected files. There is a process bar for you reference.
- g) When the system completes backup, you can see a dialogue box prompting successful backup.

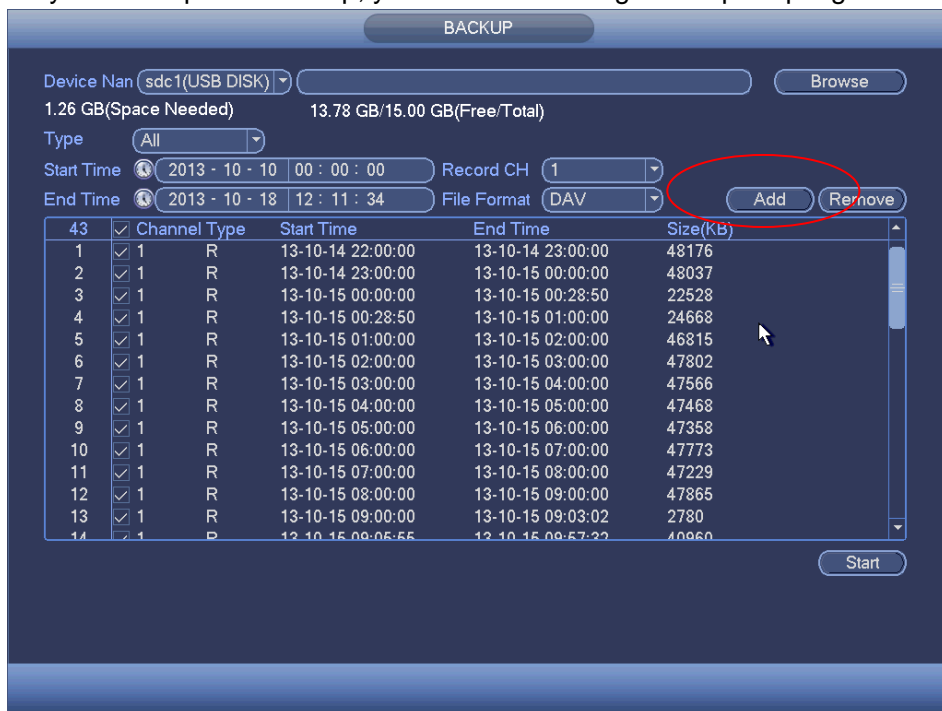

Figure 4-244

- h) Click backup button, system begins burning. At the same time, the backup button becomes stop button. You can view the remaining time and process bar at the left bottom.

 **Note**

- During backup process, you can click ESC to exit current interface for other operation (For some series product only). The system will not terminate backup process.
- The file name format usually is: Channel number+Record type+Time. In the file name, the YDM format is Y+M+D+H+M+S. File extension name is .dav.

### 4.10.8.2 Import/Export

This function allows you to copy current system configuration to other devices. It also supports import, create new folder, and delete folder and etc function.

From Main menu>Setting>System>Import/Export, you can see the configuration file backup interface is shown as below. See Figure 4-250.

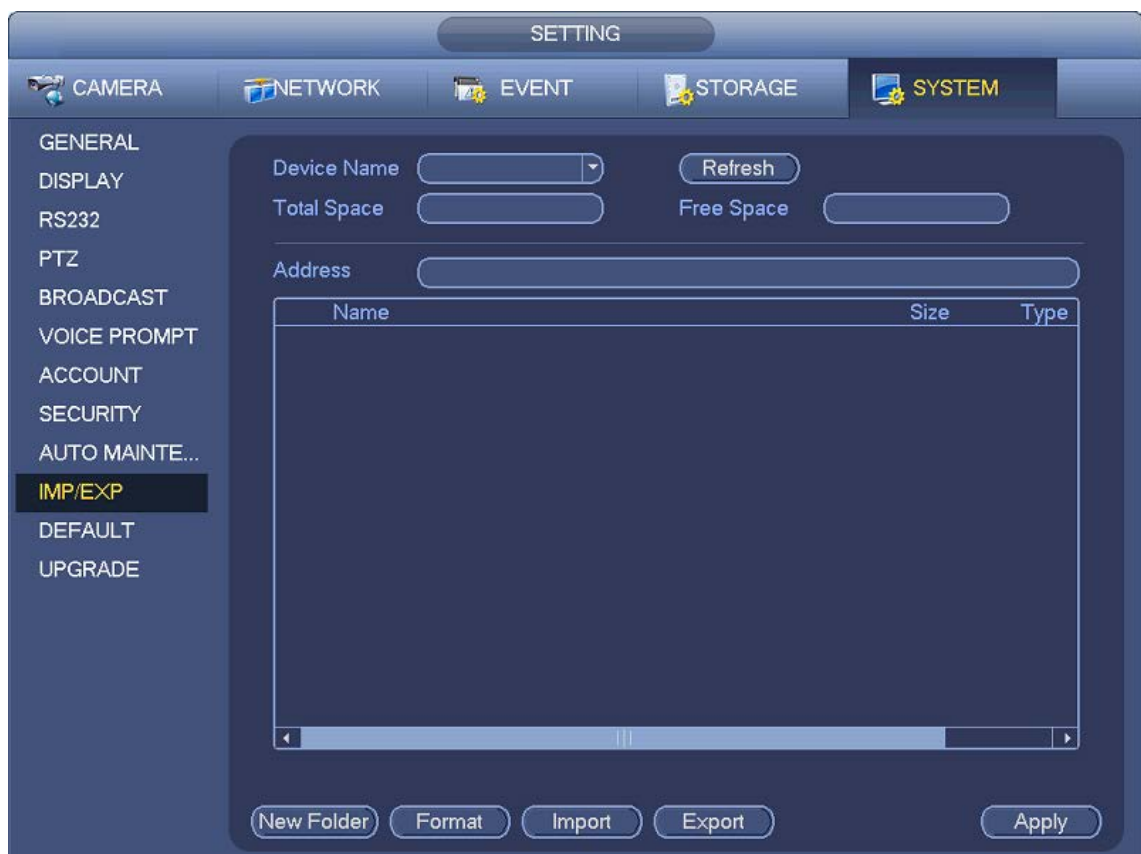

Figure 4-245

- Export: Please connect the peripheral device first and then go to the following interface. Click Export button, you can see there is a corresponding “Config\_Time” folder. Double click the folder, you can view some backup files.
- Import: Here you can import the configuration files from the peripheral device to current device. You need to select a folder first. You can see a dialogue box asking you to select a folder if you are selecting a file. System pops up a dialogue box if there is no configuration file under current folder. After successfully import, system needs to reboot to activate new setup.

- Format: Click Format button, system pops up a dialogue box for you to confirm current operation. System begins format process after you click the OK button.

 **Note**

- System cannot open config backup interface again if there is backup operation in the process.
- System refreshes device when you go to the config backup every time and set current directory as the root directory of the peripheral device.
- If you go to the configuration backup interface first and then insert the peripheral device, please click Refresh button to see the newly added device.

### 4.10.8.3 Backup Log

a) From Main menu>Info>Log, the interface is shown as below. See Figure 4-251.



Figure 4-246

- b) Select log type and then set start time/end time, click Search button, you can see log time and event information. Click  to view detailed log information.
- c) Select log items you want to save and then click backup button, you can select a folder to save them. Click Start to backup and you can see the corresponding dialogue box after the process is finish.

### 4.10.8.4 USB Device Auto Pop-up

After you inserted the USB device, system can auto detect it and pop up the following dialogue box. It allows you to conveniently backup file, log, configuration or update system. See Figure 4-252. Please



refer to chapter 4.10.8.1 file backup, chapter 4.10.8.3 backup log, chapter 4.10.8.2 import/export, and chapter 4.6.2 search for detailed information.



Figure 4-247

## 4.10.9 Default



### Warning!

After you use default function, some your customized setup may lose forever! Please think twice before you begin the operation!

You can restore factory default setup to fix some problems when the device is running slowly. Configuration error occurred.

From Main menu>Setting>System>Default, you can go to the default interface. See Figure 4-253.

Check an item you want to restore default setup, or check the All to select all items.

Click OK or apply button, system pops up a dialogue box. Click OK to restore.



Figure 4-248

## 4.10.10 Upgrade

### 4.10.10.1 File Update

Insert the USB device with the upgrade file into the NVR device and then you can upgrade the system version of the NVR device.

Step 1 Enter from main menu > Setting > System > Upgrade.

The Upgrade interface is displayed. See Figure 4-254.

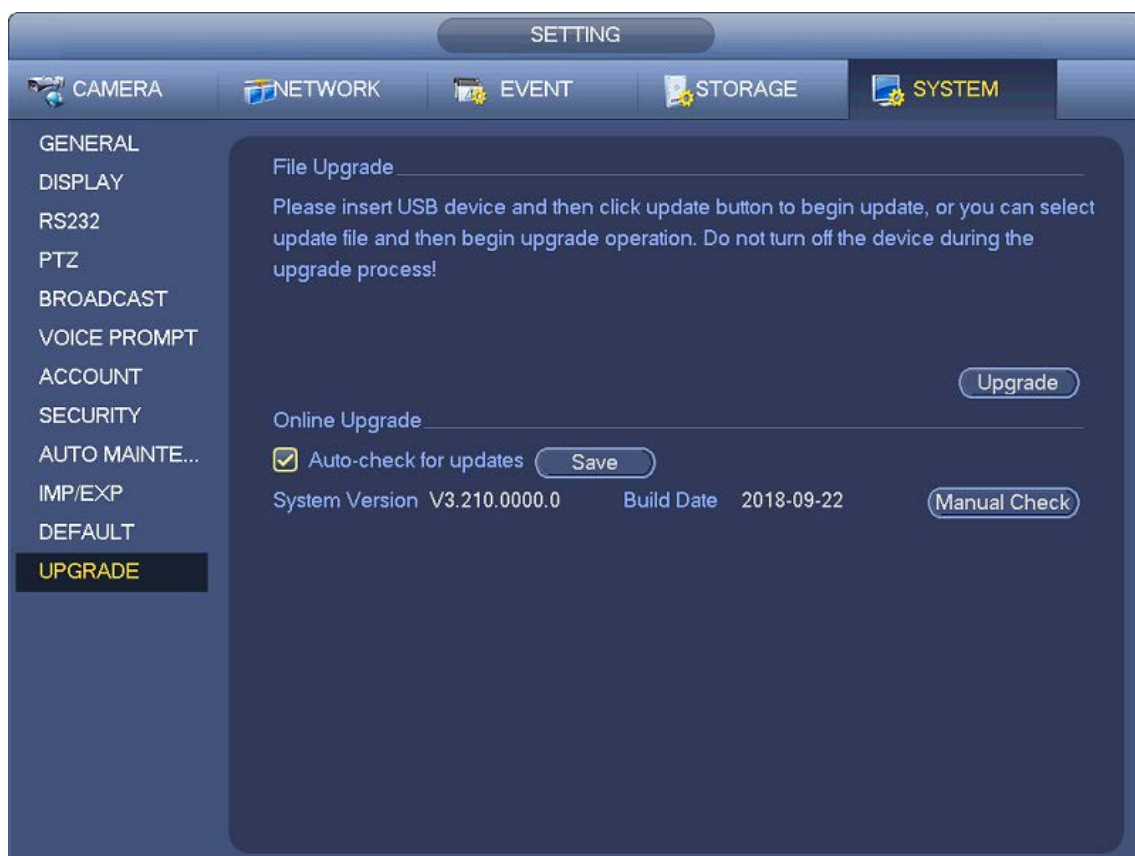

Figure 4-249

Step 2 Insert the USB device and click Upgrade.

The Upgrade interface is displayed.

Step 3 Select the upgrade file and click Start.

After the upgrade is completed, the system prompts Completed.

### 4.10.10.2 Cloud Upgrade

When the NVR is online, you can use the online upgrade to update the firmware.



#### Note

Make sure the NVR has properly connected to the network.

### Version Detection

The version detection includes auto detection and manual detection. It displays current system version and application released date.

- Enable auto detection, NVR interactive with the cloud to detect there is new version available or not.
- Click manual detection, it is to view the latest new version on the cloud.
  - ✧ If current version is the latest one, there is prompt “It is the latest version”.
  - ✧ If NVR detects there is new version available, system displays new version information such as released date and corresponding release note.

### Upgrade System



CAUTION

During the upgrade process, make sure the network connection and power supplying are both OK.

Click Start to upgrade system.

## Uboot

When NVR boots up, during the uboot process, NVR automatically detects there is USB device and there is upgrade file on the USB device or not. If the detection result is OK, NVR automatically begins upgrade.



CAUTION

- The USB device shall contain two files: u-boot.bin.img and update.img.
- The USB device shall connected to the USB port at the front panel. Otherwise, NVR cannot properly detect the file or upgrade.

## 4.11 Logout /Shutdown/Restart

From Mani menu>Operation>Shutdown, you can see an interface shown as in Figure 4-255.

- Shutdown: System shuts down and turns off power.
- Logout: Log out menu. You need to input password when you login the next time.
- Restart: reboot device.

If you shut down the device, there is a process bar for your reference, system waits for 3 seconds and then shut down (You cannot cancel).

Please note, sometimes you need to input the proper password to shut down the device.

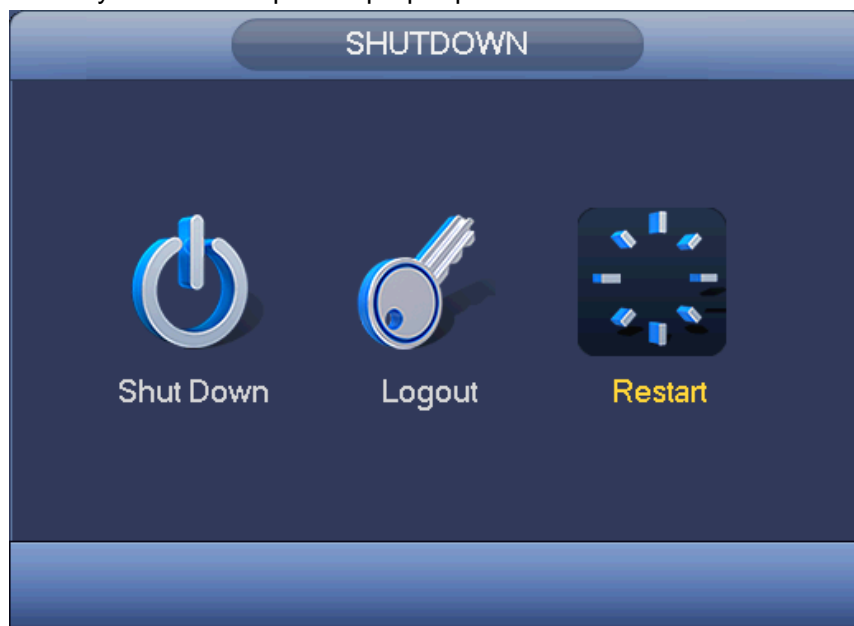

Figure 4-250

# 5 Web Operation

## 5.1 General Introduction

If it is your first time to login the device, please initialize your device first. Refer to chapter 5.2 Device Initialization for detailed information.

The device web provides channel monitor menu tree, search, alarm setup, system setup, PTZ control and monitor window and etc.

### Note

- Slight difference may be found on user interface. Please refer to the actual product for detailed information.
- Device supports various browsers such as Safari, Chrome and etc.
- Use ChromeApp to login the WEB if the Chrome version is 45 or higher. Go to the Chrome online store to download the ChromeApp installation package.

Step 1 PC and NVR connection is OK.

Step 2 Set PC IP address, NVR IP address, subnet mask and gateway.

- Set the IP address of the same section for the PC and NVR. Input corresponding gateway and subnet mask if there are routers.)
- The device default IP address is 192.168.1.108.

Step 3 Check the PC and device connection is OK or not. Refer to the following two ways to check the network connection is OK or not. When the PC and device network connection is OK, login the WEB via the PC.

- On PC, use order ping `***.***.***.***`(NVR IP address) to check connection is OK or not. Login Usually the TTL value is 255.
- Login the device local menu, from `setting>Network>Network test` and then input PC IP address. Check the connection is OK or not.

Step 4 Login the WEB. Refer to chapter 5.10 Login for detailed information.

## 5.2 Device Initialization

If it is your first time to use the device, please set a login password of **admin** (system default user).

### Note

For your device safety, please keep your login password of **admin** well after the initialization steps, and change the password regularly.

Please follow the steps listed below.

Step 1 Open the IE and then input the NVR IP address in the address column.

Step 2 Click Enter button.

Device displays device initialization interface. See Figure 5-1.

Figure 5-1

Step 3 Set login password of **admin**.

- User name: The default user name is **admin**.
- Password/confirm password: The password ranges from 8 to 32 digitals. It can contain letters, numbers and special characters (excluding “”, “'”, “,”, “:”, “&”) . The password shall contain at least two categories. Usually we recommend the strong password.



**WARNING**

**STRONG PASSWORD RECOMMENDED-For your device own safety, please create a strong password of your own choosing. We also recommend you change your password periodically especially in the high security system.**

Step 4 Click Next, device goes to the following interface. See Figure 5-2.

Figure 5-2

Step 5 Set security questions.

 **Note**

- After setting the security questions here, you can use the email you input here or answer the security questions to reset **admin** password Refer to chapter 5.4 Reset password for detailed information.
- Cancel the email or security questions box and then click Next button to skip this step.
- Email: Input an email address for reset password purpose. Scan the QR code to reset the password, you need to receive the security code by the email. Input the security code to reset the password of **admin**. In case you have not input email address here or you need to update the email information, please go to the main Setup>System>Account to set. Refer to chapter 5.11.5.7 for detailed information.
- Security question: Set security questions and corresponding answers. Properly answer the questions to reset **admin** password. In case you have not input security question here or you need to update the security question information, please go to the main menu>Setting>System>Account>Security question to set. Refer to chapter 4.10.1.3 Security question for detailed information.

 **Note**

If you want to reset password by answering security questions, please go to the local menu interface.

Step 6 Click OK to complete the device initialization setup. See Figure 5-3.



Figure 5-3

## 5.3 Log In

Open the IE and then input the NVR IP address in the address column.

For example, if your NVR IP address is 192.168.1.108, then please input http:// 192.168.1.108 in IE address column. See Figure 5-4.

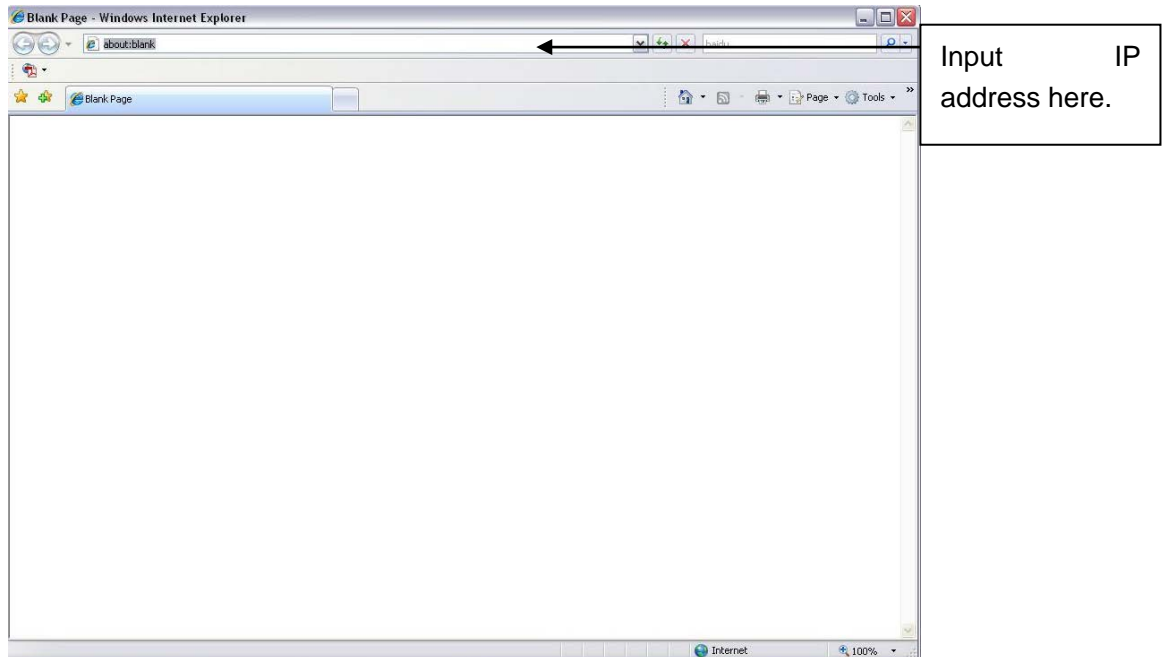

Figure 5-4

System pops up warning information to ask you whether install Web plug-in or not. Please click yes button.



After installation, the interface is shown as below. See Figure 5-5.

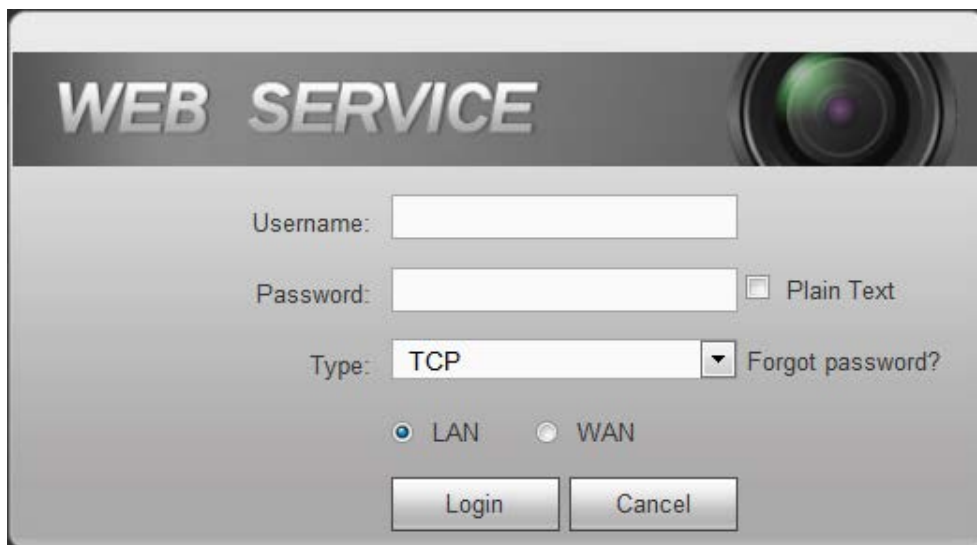

Figure 5-5

Please input your user name and password.

Factory default user name is **admin** and password is what you set in chapter 5.2 Device initialization.

## 5.4 Reset Password

If you forgot **admin** password, you can reset the password by email or by answering the security questions (local menu only).

Please follow the steps listed below.

Step 1 Go to the device login interface. See Figure 5-3.

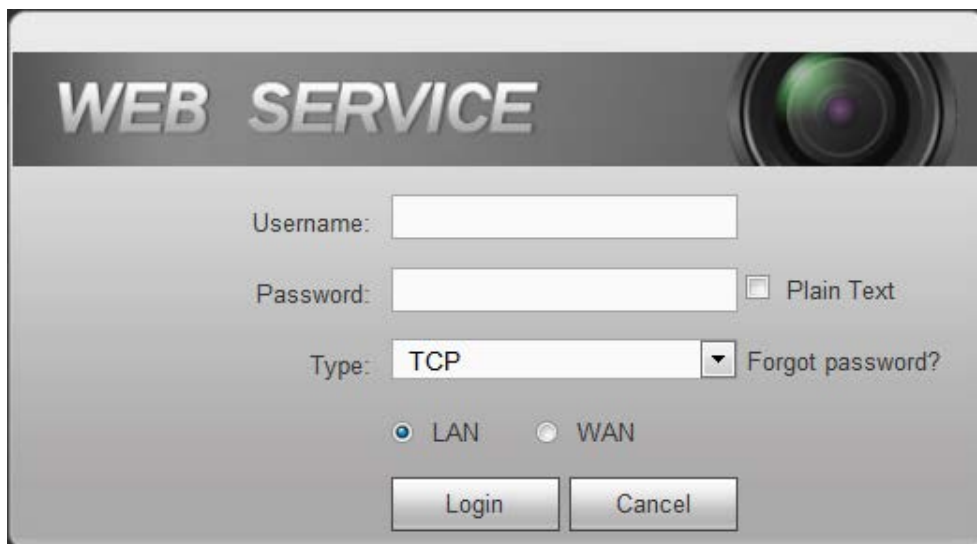

Figure 5-6

Step 2 Click Forgot password, enter the following interface. See Figure 5-7.

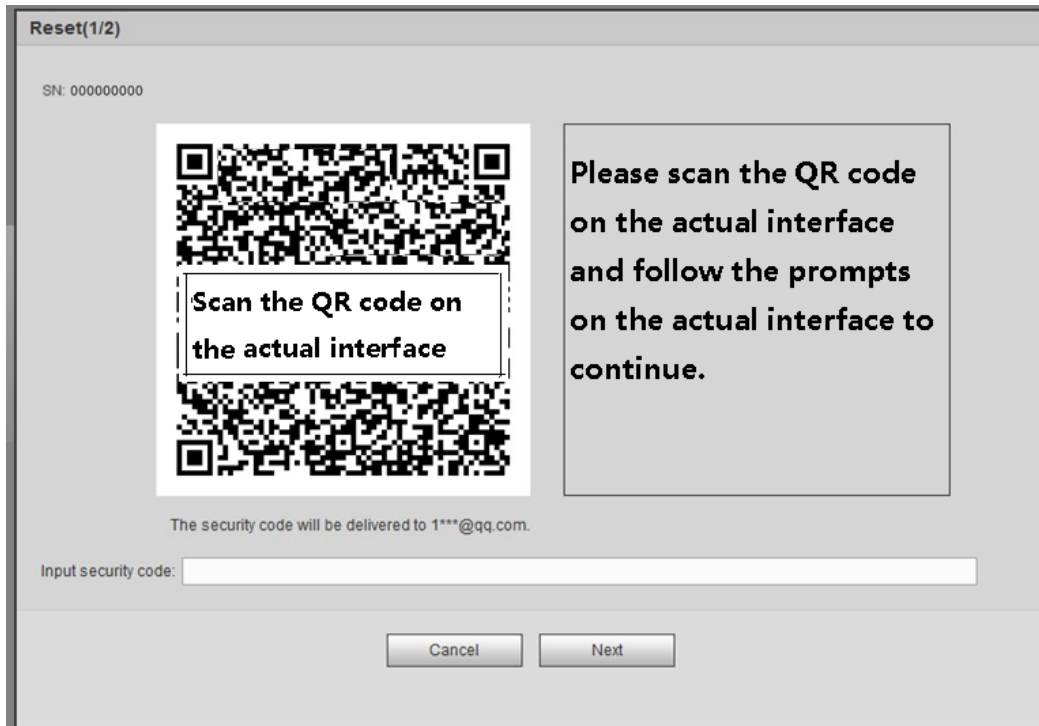

Figure 5-7

Step 3 Follow the prompts on the interface and then scan the QR code to get the security code.



**WARNING**

- ✧ For the same QR code, max scan twice to get two security codes. Refresh the QR code if you want to get security code again.
- ✧ The security code on you email is only valid for 24 hours.
- ✧ After five times security code failure, the **admin** account will be locked for 5 minutes.

Step 4 Input the security code on the email and then click Next button.

Step 5 Input new password and then confirm.



**WARNING**

**STRONG PASSWORD RECOMMENDED-For your device own safety, please create a strong password of your own choosing. The password shall be at least 8-digit containing at least two types of the following categories: letters, numbers and symbols. We also recommend you change your password periodically especially in the high security system.**

Step 6 Click OK button to complete the setup.

## 5.5 LAN Mode

For the LAN mode, after you logged in, you can see the main window. See Figure 5-13.

This main window can be divided into the following sections.

- Section 1: there are six function buttons: Live (chapter 5.6), setup (chapter 5.11), info (Chapter 5.12), playback (chapter 5.13), alarm (chapter 5.14), and logout (chapter 5.16).
- Section 2: There are monitor channels successfully connected to the NVR. Please refer to Figure 5-8 for main stream and extra stream switch information.

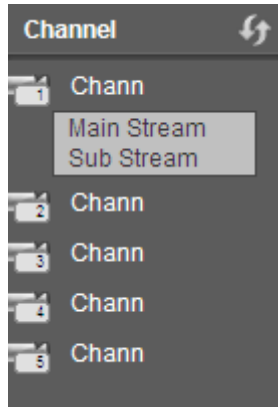

Figure 5-8

- Section 3: Open all. Open all button is to enable/disable all-channel real-time monitor. Here you can select main stream/sub stream too. See Figure 5-9.

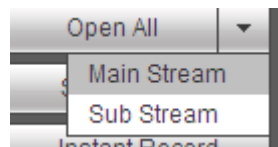

Figure 5-9

- Section 4: Start Talk button.

You can click this button to enable audio talk. Click 【▼】 to select bidirectional talk mode. There are four options: DEFAULT, G711a, G711u and PCM. See Figure 5-10.

After you enable the bidirectional talk, the Start talk button becomes End Talk button and it becomes yellow. Please note, if audio input port from the device to the client-end is using the first channel audio input port. During the bidirectional talk process, system will not encode the audio data from the 1-channel.

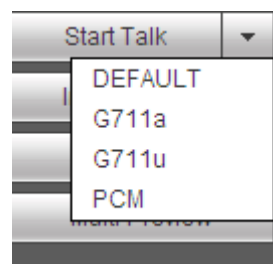

Figure 5-10

- Section 5: Instant record button. Click it, the button becomes yellow and system begins manual record. See Figure 5-11. Click it again, system restores previous record mode.

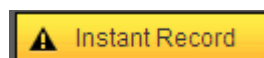

Figure 5-11

- Section 6: Local play button.

The Web can playback the saved (Extension name is dav) files in the PC-end.

Click local play button, system pops up the following interface for you to select local play file. See Figure 5-12.



Figure 5-12

- Section 7: Zero-channel encoding. Please refer to chapter 5.9 for detailed information.
- Section 8: PTZ operation panel. Please refer to chapter 5.7 for detailed information.
- Section 9: Image setup and alarm setup. Please refer to chapter 5.8 for detailed information.
- Section 10: From the left to the right ,you can see video quality/fluency/ full screen/1-window/4-window/6-window/8-window/9-window/13-window/16-window/20-window/25-window/36-window.. You can set video fluency and real-time feature priority.

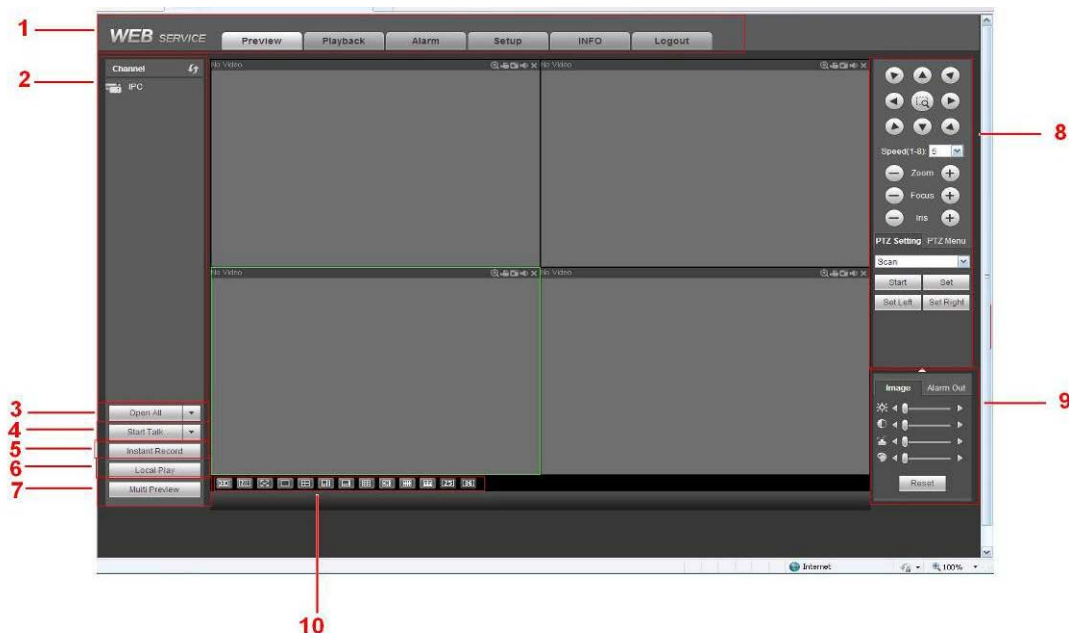

Figure 5-13

## 5.6 Real-time Monitor

In section 2, left click the channel name you want to view, you can see the corresponding video in current window.

On the top left corner, you can view device IP(172.11.10.11), channel number(1), network monitor bit stream(2202Kbps) and stream type(M=main stream, S=sub stream). See Figure 5-14.

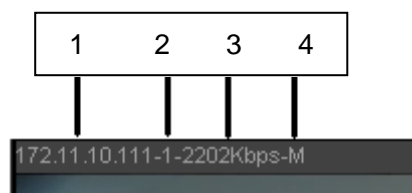

Figure 5-14

On the top right corner, there are six unction buttons. See Figure 5-15.

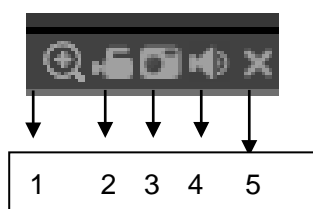

Figure 5-15

- 1: Digital zoom: Click this button and then left drag the mouse in the zone to zoom in. right click mouse system restores original status.
- 2: Local record. When you click local record button, the system begins recording and this button becomes highlighted. You can go to system folder RecordDownload to view the recorded file.
- 3: Snapshot picture. You can snapshot important video. All images are memorized in system client folder PictureDownload (default).
- 4: Audio :Turn on or off audio.(It has no relationship with system audio setup )
- 5: Close video.

## 5.7 PTZ

Before PTZ operation, please make sure you have properly set PTZ protocol. (Please refer to chapter 5.11.5.4).

There are eight direction keys. In the middle of the eight direction keys, there is a 3D intelligent positioning key.

Click 3D intelligent positioning key, system goes back to the single screen mode. Drag the mouse in the screen to adjust section size. It can realize PTZ automatically.

Please refer to the following sheet for PTZ setup information.

Parameter	Function
Scan	<ul style="list-style-type: none"> <li>● Select Scan from the dropdown list.</li> <li>● Click Set button, you can set scan left and right limit.</li> <li>● Use direction buttons to move the camera to you desired location and then click left limit button. Then move the camera again and then click right limit button to set a right limit.</li> </ul>

Parameter	Function
Preset	<ul style="list-style-type: none"> <li>● Select Preset from the dropdown list.</li> <li>● Turn the camera to the corresponding position and Input the preset value. Click Add button to add a preset.</li> </ul>
Tour	<ul style="list-style-type: none"> <li>● Select Tour from the dropdown list.</li> <li>● Input preset value in the column. Click Add preset button, you have added one preset in the tour.</li> <li>● Repeat the above procedures you can add more presets in one tour.</li> <li>● Or you can click delete preset button to remove one preset from the tour.</li> </ul>
Pattern	<ul style="list-style-type: none"> <li>● Select Pattern from the dropdown list.</li> <li>● You can input pattern value and then click Start button to begin PTZ movement such as zoom, focus, iris, direction and etc. Then you can click Add button to set one pattern.</li> </ul>
Aux	<ul style="list-style-type: none"> <li>● Please input the corresponding aux value here.</li> <li>● You can select one option and then click AUX on or AUX off button.</li> </ul>
Light and wiper	You can turn on or turn off the light/wiper.



Figure 5-16

## 5.8 Image/Alarm-out

Select one monitor channel video and then click Image button in section 9, the interface is shown as Figure 5-17.

### 5.8.1 Image

Here you can adjust its brightness, contrast, hue and saturation. (Current channel border becomes green).

Or you can click Reset button to restore system default setup.

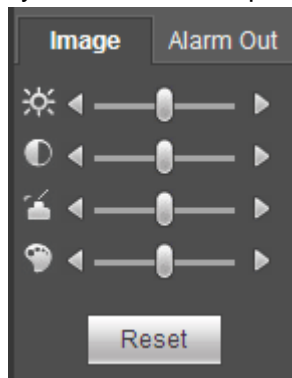

Figure 5-17

### 5.8.2 Alarm output

Here you can enable or disable the alarm signal of the corresponding port. See Figure 5-18.



Figure 5-18

## 5.9 Zero-channel Encode

Select a window and then click zero-channel encode button, the interface is shown as below. See Figure 5-19.

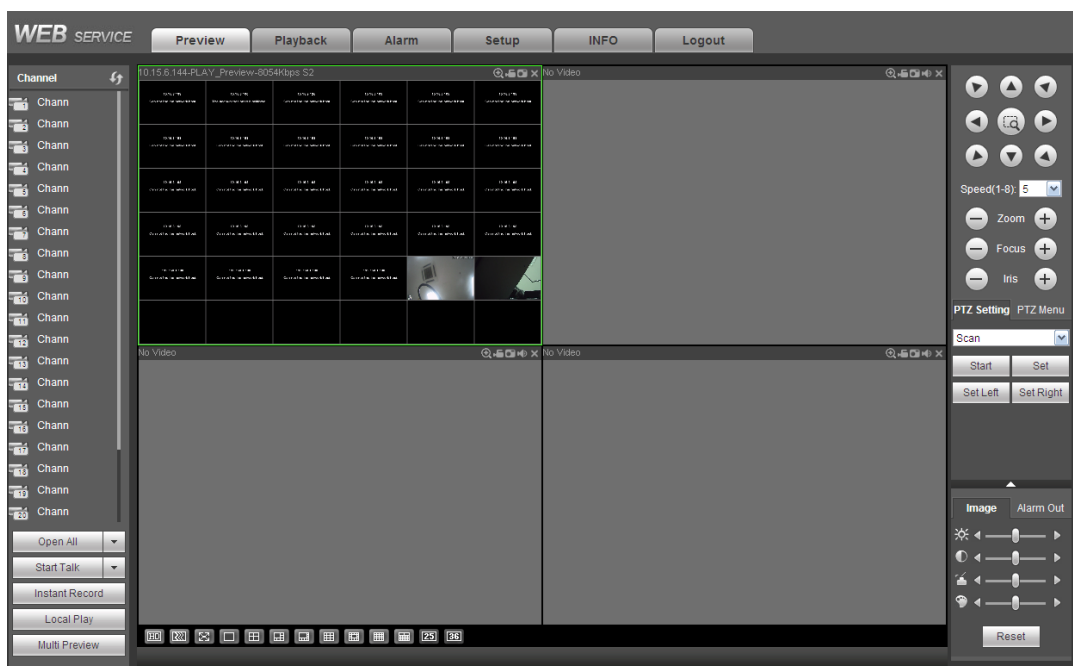

Figure 5-19

## 5.10 WAN Login

In WAN mode, after you logged in, the interface is shown as below. See Figure 5-20.



Figure 5-20

Please refer to the following contents for LAN and WAN login difference.

- 1) In the WAN mode, system opens the main stream of the first channel to monitor by default. The open/close button on the left pane is null.



2) You can select different channels and different monitor modes at the bottom of the interface. See Figure 5-21.

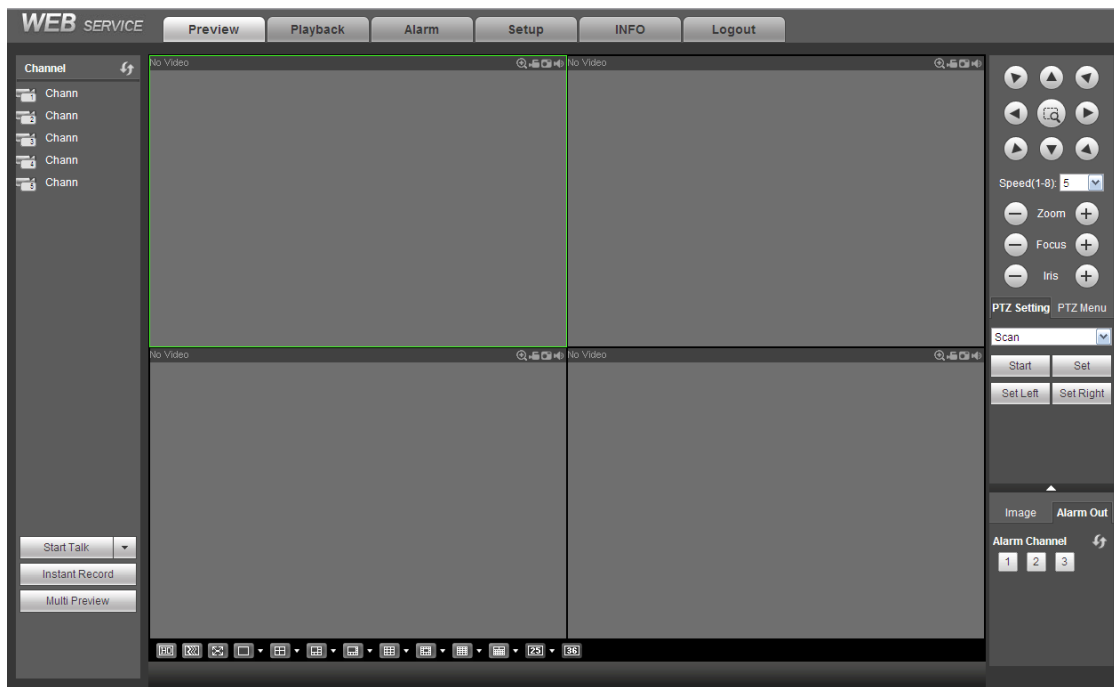

Figure 5-21

### Important

**The window display mode and the channel number are by default. For example, for the 16-channel, the max window split mode is 16.**

3) Multiple-channel monitor, system adopts extra stream to monitor by default. Double click one channel, system switches to single channel and system uses main stream to monitor. You can view there are two icons at the left top corner of the channel number for you reference. M stands for main stream. S stands for sub stream (extra stream).

4) If you login via the WAN mode, system does not support alarm activation to open the video function in the Alarm setup interface.

### Important

- For multiple-channel monitor mode, system adopts extra stream to monitor by default. You cannot modify manually. All channels are trying to synchronize. Please note the synchronization effect still depends on your network environments.
- For bandwidth consideration, system cannot support monitor and playback at the same time. System auto closes monitor or playback interface when you are searching setup in the configuration interface. It is to enhance search speed.

# 5.11 Setup

## 5.11.1 Image

### 5.11.1.1 Registration

#### 5.11.1.1.1 Registration

Select Setup >Image>Registration>Registration, you can see the following interface. See Figure 5-22.

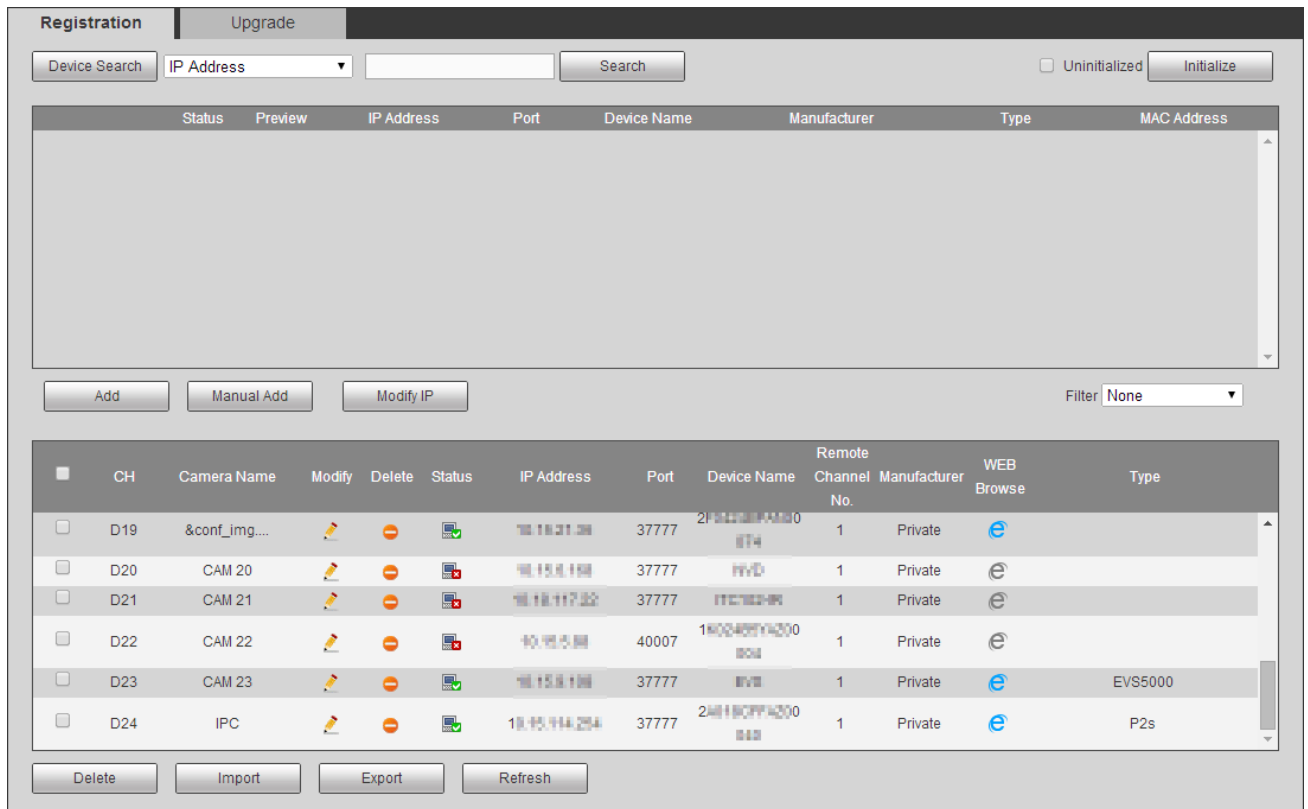





Figure 5-22

Please refer to the following sheet for parameter information.

Parameter	Function
	Select IP address or the MAC address from the dropdown list and then input the corresponding information, click Search button to view the results.
Search	Click Search button, you can view the searched device information on the list. It includes device IP address, port, device name, manufacturer and type.
Uninitialized	Click to search the initialized devices. Select an uninitialized device and then click the Initialize button to set the account.
Preview	Click  to view the preview video of the remote device.

Parameter	Function
State	It is to display the device has been initialized or not. That is to say, the remote device has set the initial account information or not.  means the remote device has initialized,  means the remote device has not been initialized.
Add	Select a device in the list and then click Add button, system can connect the device automatically and add it to the Added device list. Or you can double click one item in the list to add a device.
Modify	Click  or any device in the Added device list, you can change the corresponding channel setup.
Delete	Click  , you can delete the remote connection of the corresponding channel.
Delete	Select a device in the Added device list and then click Delete button, system can disconnect the device and remove it from the Added device list.
Manual Add	Click it, the interface is shown as in Figure 5-23. Here you can add network camera manually. You can select a channel from the dropdown list (Here only shows disconnection channel.)

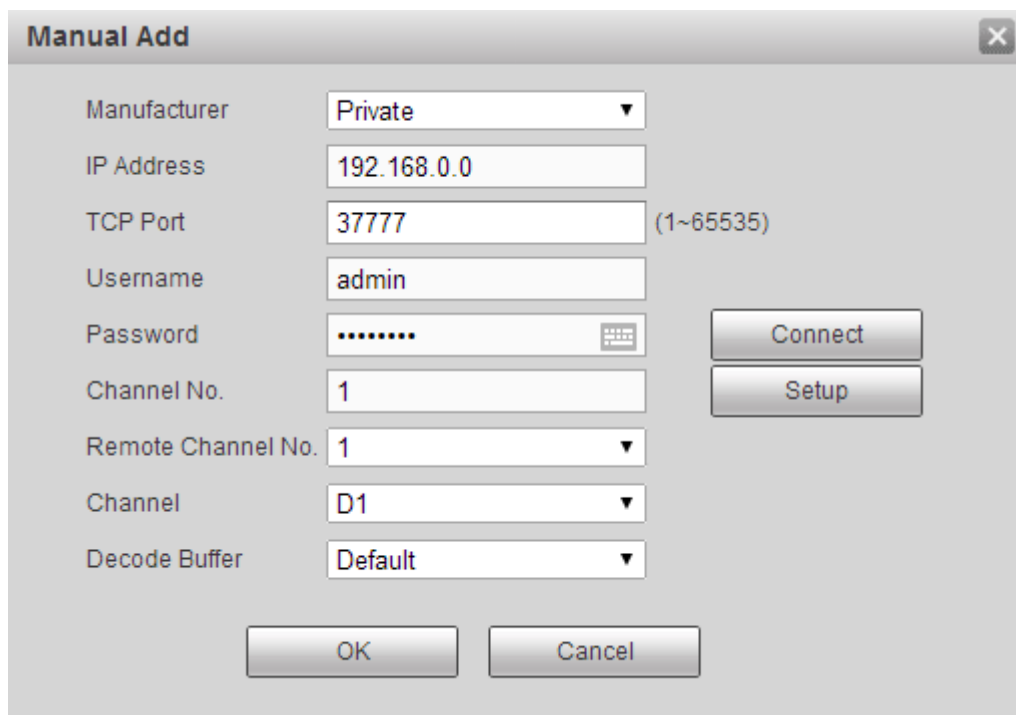







Figure 5-23

Please refer to the following sheet for parameter information.

Parameter	Function
Manufacturer	Please select from the dropdown list.  <b>Note</b> Different series products may support different manufacturers, please refer to the actual product.
IP address	Input remote device IP address.
RTSP port	Input RTSP port of the remote device. The default setup is 554.  <b>Note</b> Skip this item if the manufacture is private or customized.
HTTP port	Input HTTP port of the remote device. The default setup is 80.  <b>Note</b> Skip this item if the manufacture is private or customized.
TCP port	Input TCP port of the remote device. The default setup is 37777.
User name/password	The user name and password to login the remote device.
Channel No.	Input channel amount or click the Connect button to get the channel amount of the remote device.  <b>Note</b> We recommend click Connect button to get remote device channel amount, the manual add operation may result in failure if the input channel amount is not right.
Remote channel No.	After getting the remote device channel amount, click Setup to select a channel.  <b>Note</b> Click to select one or more remote channel numbers here.
Channel	The local channel number you want to add. One channel name has corresponding one channel number.
Decode buffer	There are three item: realtime, local, fluent.
Service type	There are four items: auto/TCP/UDP/MULTICAST(ONVIF device only)  <b>Note</b> <ul style="list-style-type: none"> <li>The default connection mode is TCP if the connection protocol is private.</li> <li>There are three items:TCP/UDP/MULTICAST if the connection protocol is ONVIF.</li> <li>There are two items: TCP/UDP if the connection protocol is from the third-party.</li> </ul>

### Change IP

On the searched devices list, check one or more device(s) at the same time. Click Modify IP button, you can see the following interface. See Figure 5-24

Please refer to the following sheet for log parameter information.

Parameter	Function
DHCP	Check the box here, system can auto allocate the IP address. The IP address, subnet mask, default gateway are reference only.
Static	Check the box here, you can set IP address, subnet mask, default gateway manually.
IP address/subnet mask/default gateway	You can input corresponding information here.
User name/password	The account you login the remote device. Please input here to password verification to change the remote device password.
Incremental value	When you want to change several IP addresses, once you input the IP address of the first device, the IP address of the next device will increase accordingly. For example, when the incremental value is 1, if the IP address of the first device is 172.10.3.128, the IP address of the second device will auto be set as 172.10.3.129.

**Note**

For the static IP address, system will alert you if there is any IP conflict. If you are changing several IP addresses at the same time, system auto skip the conflicted IP and auto allocate again according to the incremental value you set.

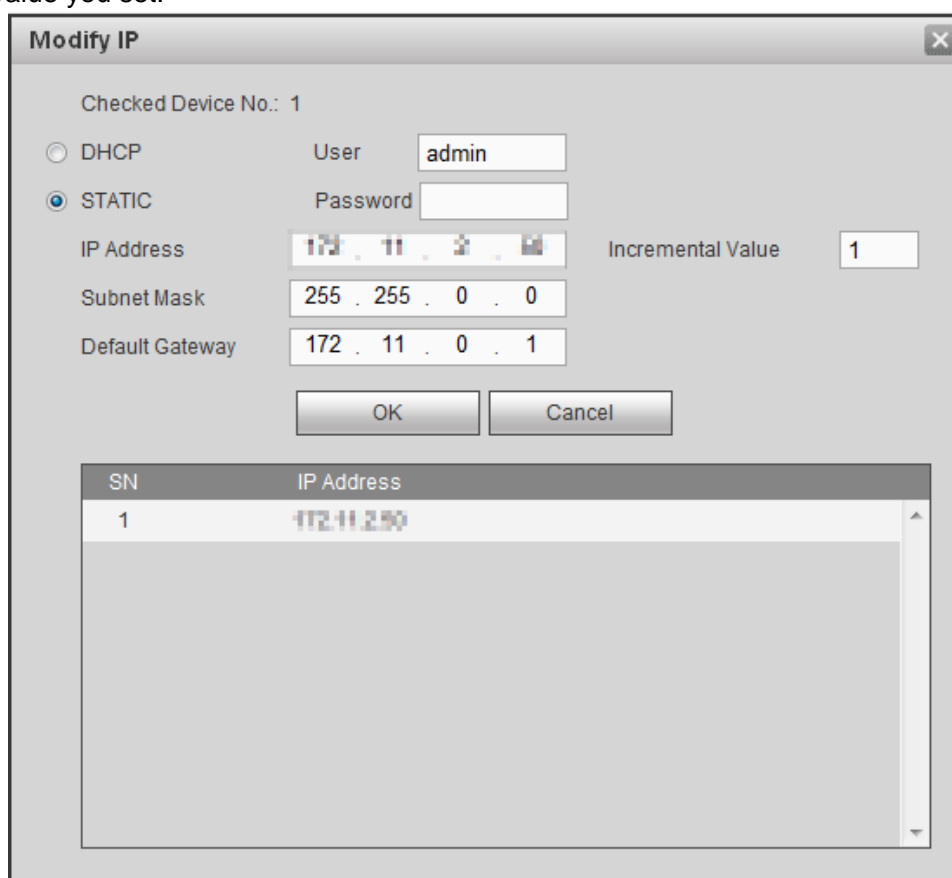

Figure 5-24

## Export IP

You can export the list of the added devices to your local PC. Click Export button and then select the saved path. Click OK. You can see “Backup completed” prompt.

### Note

The export file extension name is .CVS. The file contains IP address, port, remote channel No. manufacturer, user name, password and etc.

## Import IP

You can import the added device list to add the device conveniently. Click Import button, and then select the import file.

### Note

If the imported IP is already in the added device list, system pops up dialogue box for you to confirm overwrite or not.

- Click OK button, the new IP setup can overwrite the old one.
- Click Cancel button, system adds the new IP setup.



### Important

- You can edit the exported file. Please make sure the file format is the same. Otherwise you cannot import the file again!
- System does not support customized protocol import/export.
- The import/export function is for the devices of the same language.

## 5.11.1.1.2 IPC Upgrade

This interface is to upgrade network camera.

From Main menu>Setting>Camera>Registration>IPC upgrade, enter the following interface. See Figure 5-25.

Click Browse button to select upgrade file. Or you can use filter to select several network cameras at the same time.

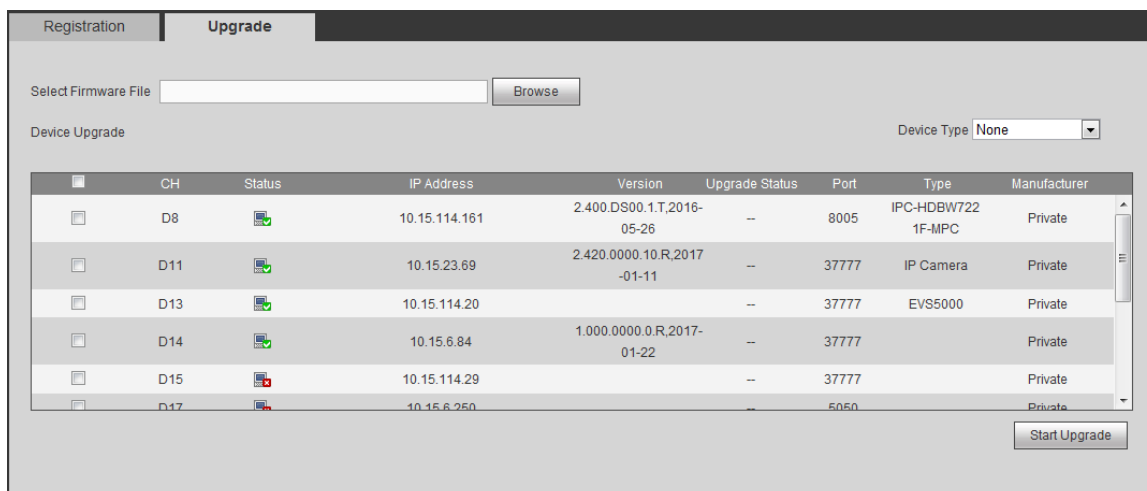

CH	Status	IP Address	Version	Upgrade Status	Port	Type	Manufacturer
D8		10.15.114.161	2.400.DS00.1.T,2016-05-26	--	8005	IPC-HDBW7221F-MPC	Private
D11		10.15.23.69	2.420.0000.10.R,2017-01-11	--	37777	IP Camera	Private
D13		10.15.114.20		--	37777	EVS5000	Private
D14		10.15.6.84	1.000.0000.0.R,2017-01-22	--	37777		Private
D15		10.15.114.29		--	37777		Private
D17		10.15.6.250		--	5050		Private

Figure 5-25

### 5.11.1.2 Image

 **Note**

Slight difference may be found since the connected network camera may not be same model.

Here you can view device property information. The setups become valid immediately after you set. See Figure 5-26.

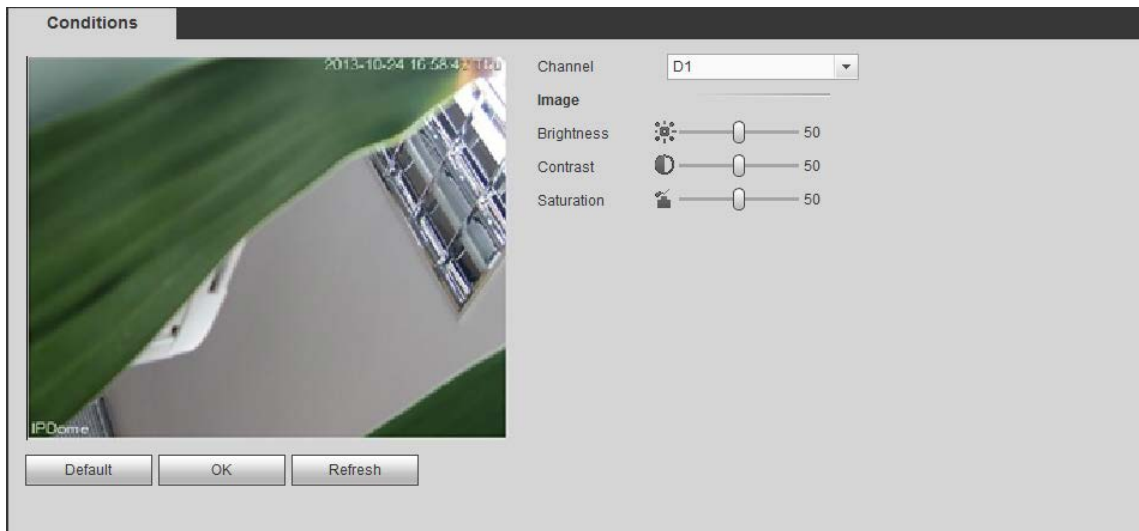

Figure 5-26

Please refer to the following sheet for detailed information.

Parameter	Function
Channel	Please select a channel from the dropdown list.
Brightness	It is to adjust monitor window brightness. The default value is 50. The larger the number is, the bright the video is. When you input the value here, the bright section and the dark section of the video will be adjusted accordingly. You can use this function when the whole video is too dark or too bright. Please note the video may become hazy if the value is too high. The value ranges from 0 to 100. The recommended value ranges from 40 to 60.
Contrast	It is to adjust monitor window contrast. The value ranges from 0 to 100. The default value is 50. The larger the number is, the higher the contrast is. You can use this function when the whole video bright is OK but the contrast is not proper. Please note the video may become hazy if the value is too low. If this value is too high, the dark section may lack brightness while the bright section may over exposure. The recommended value ranges from 40 to 60.
Saturation	It is to adjust monitor window saturation. The value ranges from 0 to 100. The default value is 50. The larger the number is, the strong the color is. This value has no effect on the general brightness of the whole video. The

	video color may become too strong if the value is too high. For the grey part of the video, the distortion may occur if the white balance is not accurate. Please note the video may not be attractive if the value is too low. The recommended value ranges from 40 to 60.
--	---

### 5.11.1.3 Encode

#### 5.11.1.3.1 Encode

The encode interface is shown as below. See Figure 5-27.

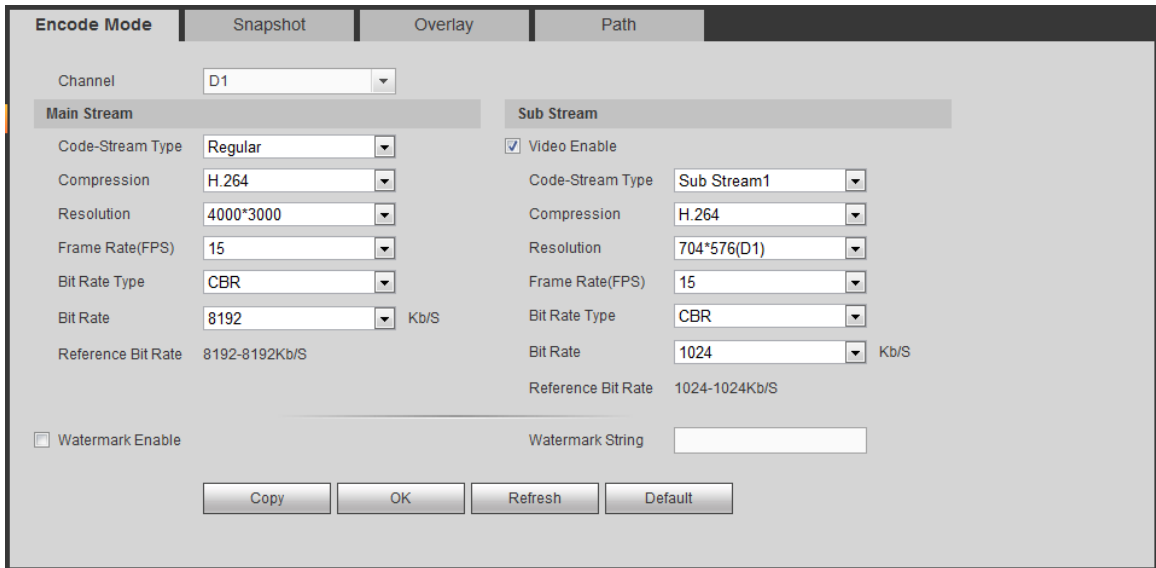



Figure 5-27

Please refer to the following sheet for detailed information.

Parameter	Function
Channel	Please select a channel from the dropdown list.
Video enable	Check the box here to enable extra stream video. This item is enabled by default.
Code stream type	It includes main stream, motion stream and alarm stream. You can select different encode frame rates form different recorded events. System supports active control frame function (ACF). It allows you to record in different frame rates. For example, you can use high frame rate to record important events, record scheduled event in lower frame rate and it allows you to set different frame rates for motion detection record and alarm record.



Compression	<p>Video encode mode.</p> <ul style="list-style-type: none"> <li>● H.264: Main Profile encode mode.</li> <li>● H.264H: High Profile encode mode.</li> <li>● H.264B: Baseline Profile encode mode.</li> <li>● H.265: Main Profile encode mode.</li> <li>● MJPEG: System needs high bit streams to guarantee video definition. Use the recommended max bit stream value to get the better video effect.</li> </ul>
Smart Codec	<p>This function is to reduce bit streams.</p> <p> <b>Note</b></p> <ul style="list-style-type: none"> <li>● Some series products support smart codec function.</li> <li>● After changing smart code, please reboot network camera and some network camera functions (such as IVS, ROI, SVC, lobby mode and etc.) becomes null. Please think twice before the operation.</li> </ul>
Resolution	The resolution here refers to the capability of the network camera.
Frame Rate	The video frame amount displayed in each second. The higher the frame rate is, the clearer and more fluent the video is. The frame rate may vary depending on the resolution.
Bit Rate	<ul style="list-style-type: none"> <li>● Main stream: You can set bit rate here to change video quality. The large the bit rate is, the better the quality is. Please refer to recommend bit rate for the detailed information.</li> <li>● Extra stream: In CBR, the bit rate here is the max value. In dynamic video, system needs to low frame rate or video quality to guarantee the value. The value is null in VBR mode.</li> </ul>
Bit rate type	<p>System supports two types: CBR and VBR.</p> <ul style="list-style-type: none"> <li>● Main stream: It is to set frame rate to change video quality. The higher the frame rate is, the better the video quality is. The referenced bit rate is the recommended value.</li> <li>● Sub stream: In CBR mode, the bit stream is near the specified value. In VBR mode, the video quality changes according to the bit stream value. But its max value is near the specified value. Reference bit rate: The reference bit rate depends on the resolution and frame rate you set.</li> </ul>
Reference bit rate	Recommended bit rate value according to the resolution and frame rate you have set.
I Frame	<p>Here you can set the P frame amount between two I frames. The value ranges from 1 to 150. Default value is 50.</p> <p>Recommended value is frame rate *2.</p>

Video/audio	You can enable or disable the video/audio. The main stream is enabled by default. After enable the audio function, the record file is composite file consisting of the video and audio. For the stream 1, please enable video first and then enable audio function.
Audio format	Set audio encode format.   <b>Note</b> Different series products support different audio encode modes. Please refer to the actual interface for detailed information.
Sampling rate	Audio sampling rate refers to the sampling amount within one second. The higher the value is, the better the audio is. The default setup is 8K.
Watermark enable	This function allows you to verify the video is tampered or not. Here you can select watermark bit stream, watermark mode and watermark character. Default character is DigitalCCTV. The max length is 85-digit. The character can only include number, character and underline.

### 5.11.1.3.2 Snapshot

The snapshot interface is shown as in Figure 5-28.



Figure 5-28

Please refer to the following sheet for detailed information.

Parameter	Function
Snapshot type	There are two modes: Regular (schedule) and Trigger. <ul style="list-style-type: none"> <li>● Regular snapshot is valid during the specified period you set.</li> <li>● Trigger snapshot only is valid when motion detect alarm, tampering alarm or local activation alarm occurs.</li> </ul>
Image size	It is the same with the resolution of the main stream.
Quality	It is to set the image quality. There are six levels.
Interval	It is to set snapshot frequency. The value ranges from 1s to 7s. Or you can set customized value. The max setup is 3600s/picture.
Copy	Click it; you can copy current channel setup to other channel(s).

### 5.11.1.3.3 Video Overlay

The video overlay interface is shown as in Figure 5-29.

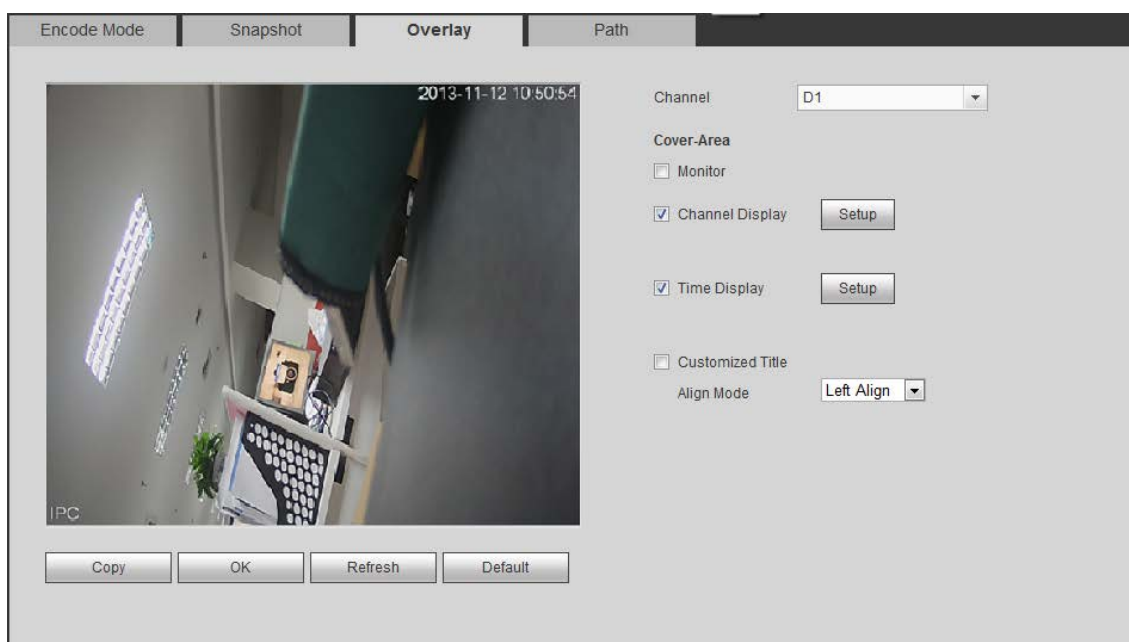

Figure 5-29

Please refer to the following sheet for detailed information.

Parameter	Function
Cover-area	Check Preview or Monitor first. Click Set button, you can privacy mask the specified video in the preview or monitor video. System max supports 4 privacy mask zones.
Time Display	You can enable this function so that system overlays time information in video window. You can use the mouse to drag the time title position. You can view time title on the live video of the WEB or the playback video.
Channel Display	You can enable this function so that system overlays channel information in video window. You can use the mouse to drag the channel title position. You can view channel title on the live video of the WEB or the playback video.

### 5.11.1.3.4 Path

The storage path interface is shown as in Figure 5-30.



Here you can set snap image saved path ( in the preview interface) and the record storage path ( in the preview interface). The default setup is C:\PictureDownload and C:\RecordDownload. Please click the Save button to save current setup.



Figure 5-30

### 5.11.1.4 Channel Name

Here you can set channel name. See Figure 5-31.

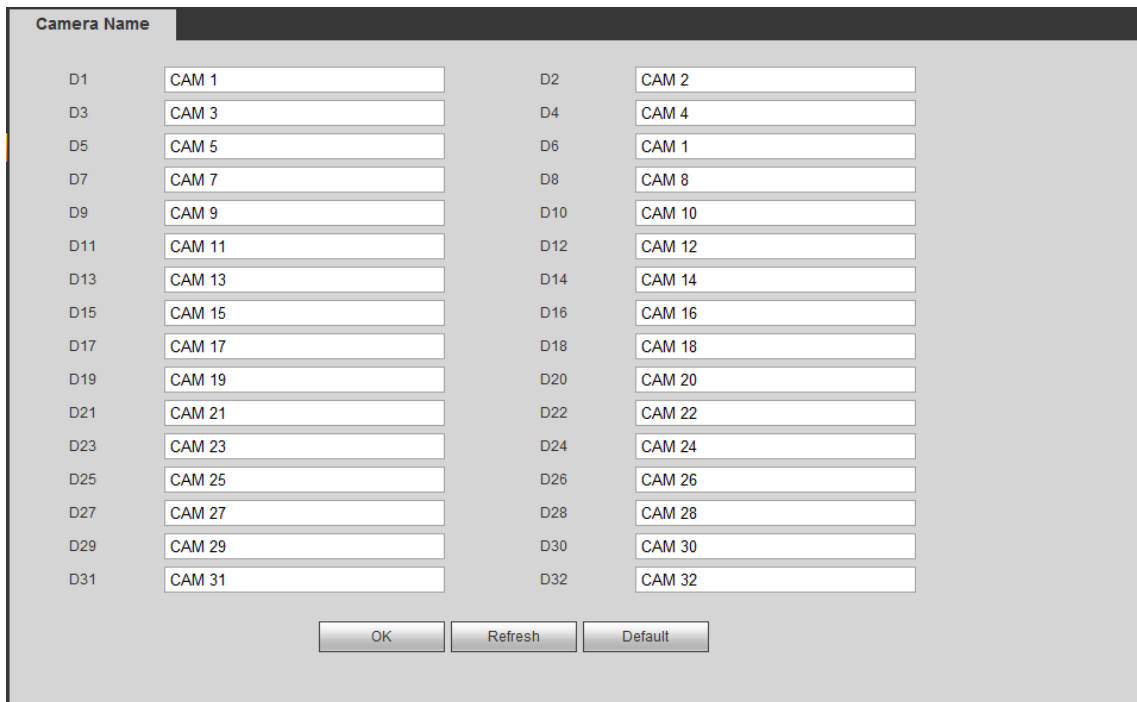

Figure 5-31

## 5.11.2 Network

### 5.11.2.1 TCP/IP

According to the network plan to set information such as IP address and DNS server.



Before configuring the network parameters, make sure that the NVR is accessing the network properly.

Step 1 Select Setup > Network > TCP/IP.

The TCP/IP interface is shown as in Figure 5-32.

Figure 5-32

Please refer to the following table for detailed information.

Parameter	Description
IP Version	<p>You can select IPv4 or IPv6. Both types are supported currently.</p> <p> <b>Note</b></p> <p>The IP address, default gateway, preferred DNS and alternate DNS for IPv6 are 128 digits. It cannot be blank.</p>
Preferred DNS	DNS server IP address.
Alternate DNS	DNS server alternate IP address.
Default Card	Set according to the actual situation. It shall be in the same network segment with the IP address.
DHCP	<ul style="list-style-type: none"> <li>When the IP of default card is DHCP, DNS supports manual setting and DHCP. The Enable check box of DHCP is available to select.</li> <li>When the IP of default card is manual, DNS only supports manual setting. The Enable check box of DHCP is unavailable (grey).</li> <li>When DHCP is enabled, DNS server address is unavailable (grey).</li> </ul>
LAN Download	<p>When network bandwidth allows, the speed of LAN download is 1.5 to 2 times of the average download speed.</p> <p> <b>Note</b></p> <ul style="list-style-type: none"> <li>The IP address, default gateway, preferred DNS and alternate DNS for IPv6 are 128 digits. It cannot be blank.</li> <li>Only some series support this function. See the actual situation.</li> </ul>

Step 2 Click .

The Edit interface is displayed. See Figure 5-33.

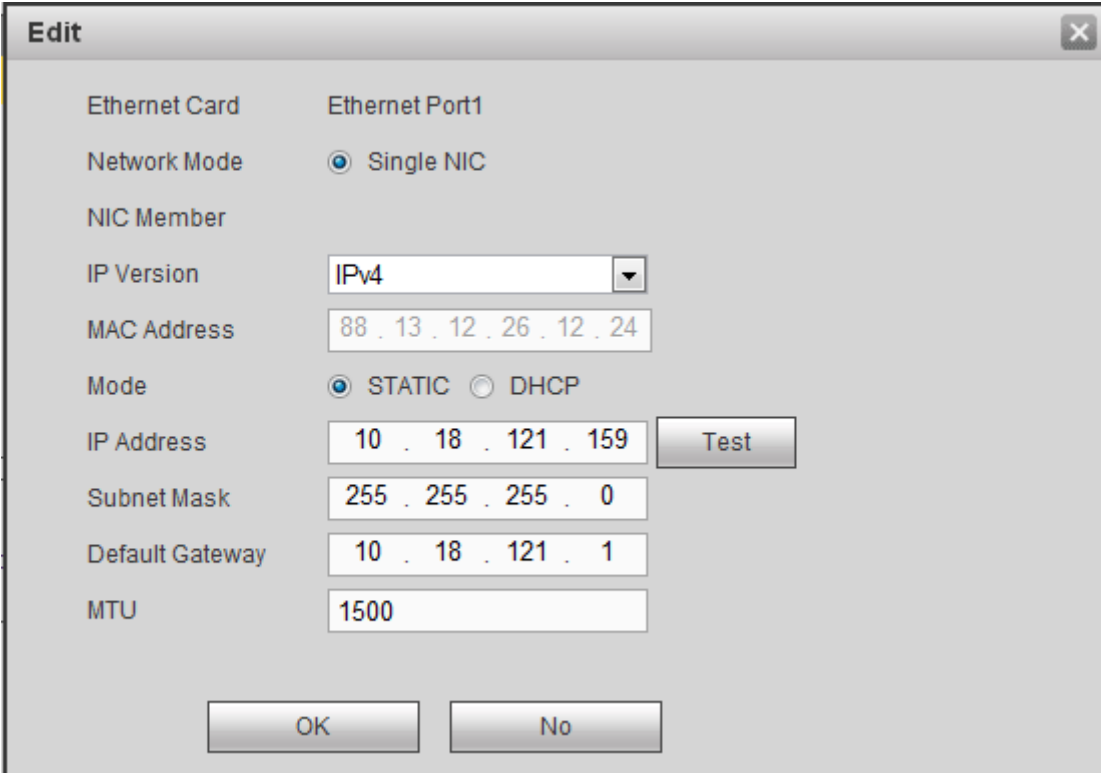

**Edit**

Ethernet Card Ethernet Port1

Network Mode  Single NIC

NIC Member

IP Version IPv4

MAC Address 88 . 13 . 12 . 26 . 12 . 24

Mode  STATIC  DHCP

IP Address 10 . 18 . 121 . 159 Test

Subnet Mask 255 . 255 . 255 . 0

Default Gateway 10 . 18 . 121 . 1



MTU 1500

OK No

Figure 5-33

Step 3 Configure the parameters. For details, see the following table.

Parameter	Description
-----------	-------------

Parameter	Description
Network Mode	<ul style="list-style-type: none"> <li>● Single NIC: Ethernet card operates separately. You can use the services such as HTTP, RTP service via etho0 or the eth1. Usually you need to set one default card (default setup is etho) to request the auto network service form the device-end such as DHCP, email, FTP and etc. In multiple-address mode, system network status is shown as offline once one card is offline.</li> <li>● Network fault-tolerance: In this mode, device uses bond0 to communicate with the external devices. You can focus on one host IP address. At the same time, you need to set one master card. Usually there is only one running card (master card).System can enable alternate card when the master card is malfunction. The system is shown as offline once these two cards are both offline. Please note these two cards shall be in the same LAN.</li> <li>● Load balance: In this mode, device uses bond0 to communicate with the external device. The eth0 and eth1 are both working now and bearing the network load. Their network load are general the same. The system is shown as offline once these two cards are both offline. Please note these two cards shall be in the same LAN.</li> </ul> <p> <b>Note</b></p> <p>Different models have different NIC numbers. See the actual situation.</p>
NIC Member	<p>Select the check box to select the NIC to bind. The binding comes into effect only after device reboot.</p> <p> <b>Note</b></p> <p>In fault-tolerance and load-balancing mode, binding network cards is supported, and the card number shall be no less than 2. Ports of different materials (such as optical port and electrical port) cannot be bound to each other</p>
IP Version	You can select IPv4 or IPv6. Both types are supported currently.
MAC Address	Display the MAC address.
Mode	<p>The way for front-end device to obtain the IP address.</p> <ul style="list-style-type: none"> <li>● Static: Manually set the IP address, subnet mask and gateway.</li> <li>● DHCP: Obtain IP automatically. When DHCP is enabled, IP address, sebnnet mask and default gateway cannot be entered. <ul style="list-style-type: none"> <li>◇ If the DHCP is effective, the system displays the obtained IP address / subnet mask / gateway. Otherwise, it displays 0.</li> <li>◇ If you want to view the current IP, when DHCP is not in effect, you can close DHCP and system displays the original IP info. If DHCP is in effect, system cannot display the original IP info even after you close DHCP. You need to reset the IP parameters.</li> <li>◇ When PPPoE dialing is enabled, IP address, subnet mask, default gateway and DHCP cannot be changed.</li> </ul> </li> </ul>

Parameter	Description
IP Address	Enter the IP address, subnet mask and default gateway you want to set. Default gateway and IP address shall be in the same network segment.
Subnet Mask	
Default Gateway	
MTU	<p>It is to set MTU value of the network adapter. The value ranges from 1280-72 bytes. The default setup is 1500 bytes. Please note MTU modification may result in network adapter reboot and network becomes off. That is to say, MTU modification can affect current network service. System may pop up dialog box for you to confirm setup when you want to change MTU setup. Click OK button to confirm current reboot, or you can click Cancel button to terminate current modification. Before the modification, you can check the MTU of the gateway. The MTU of the NVR shall be the same as or is lower than the MTU of the gateway. In this way, you can reduce packets and enhance network transmission efficiency.</p> <p>The following MTU value is for reference only.</p> <ul style="list-style-type: none"> <li>✧ 1500: Ethernet information packet max value and it is also the default value. It is the typical setup when there is no PPPoE or VPN. It is the default setup of some router, switch or the network adapter.</li> <li>✧ 1492: Recommend value for PPPoE.</li> <li>✧ 1468: Recommend value for DHCP.</li> </ul>

Step 4 Click OK to complete the Ethernet card edit.  
System returns to the TCP/IP interface.

 **Note**

Click  to unbind the the Ethernet card. The unbinding comes into effect only after device reboot.

Step 5 Click OK to save the configuration.

### 5.11.2.2 Port

The port interface is shown as in Figure 5-34.



PORT	HTTPS
Max Connection	<input type="text" value="128"/> (1~128)
TCP Port	<input type="text" value="37777"/> (1025~65535)
UDP Port	<input type="text" value="37778"/> (1025~65535)
HTTP Port	<input type="text" value="80"/> (1~65535)
HTTPS Port	<input type="text" value="443"/> (1~65535) <input type="checkbox"/> Enable
RTSP Port	<input type="text" value="554"/> (1~65535)
POS Port	<input type="text" value="38800"/> (1~65535)
RTSP Format	rtsp://<Username>:<Password>@<IP Address>:<Port>/cam/realmonitor?channel=1&subtype=0 channel: Channel, 1-32; subtype: Code-Stream Type, Main Stream 0, Sub Stream 1.
<input type="button" value="OK"/> <input type="button" value="Refresh"/> <input type="button" value="Default"/>	

Figure 5-34

Please refer to the following sheet for detailed information.

Parameter	Function
Max connection	The max client login amount (such as WEB, platform, cellphone and etc). The value ranges from 1 to 128(default).
TCP port	The default value is 37777. You can input the actual port number if necessary.
UDP port	The default value is 37778. You can input the actual port number if necessary.
HTTP port	The default value is 80. You can input the actual port number if necessary.
HTTPS	The default value is 443. You can input the actual port number if necessary.
RTSP port	The default value is 554.
POS port	The default value is 38800.

### 5.11.2.3 PPPoE

The PPPoE interface is shown as in Figure 5-35.

Input the PPPoE user name and password you get from the IPS (internet service provider) and enable PPPoE function. Please save current setup and then reboot the device to get the setup activated.

Device connects to the internet via PPPoE after reboot. You can get the IP address in the WAN from the IP address column.

**Please note, you need to use previous IP address in the LAN to login the device. Please go to the IP address item to via the device current device information. You can access the client-end via this new address.**

**PPPoE**

Enable

Username

Password

IP Address

Figure 5-35

### 5.11.2.4 DDNS

The DDNS interface is shown as in Figure 5-36.

The DDNS is to set to connect the various servers so that you can access the system via the server. Please go to the corresponding service website to apply a domain name and then access the system via the domain. It works even your IP address has changed.

Please select DDNS from the dropdown list (Multiple choices). Before you use this function, please make sure your purchased device support current function.

**DDNS**

Enable

DDNS Type

Host IP

Domain Name

Username

Password

Interval  Min. (1440~2880)

Figure 5-36

Please refer to the following sheet for detailed information.

Parameter	Function
DDNS Type	You can select DDNS protocol from the dropdown list and then enable DDNS function.
Host IP	DDNS server IP address

Parameter	Function
Domain Name	The domain name registered by the user on the DDNS server provider website.
Username	The user name you input to log in the server.
Password	The password you input to log in the server.
Interval	Specifies the interval at which the update request is periodically initiated after the DDNS update is started. The unit is minute.

After setting, click Save button.

Input full domain name on the browser and click Enter button. The setting is right if you can view device WEB interface. Otherwise, please check the parameters.

### 5.11.2.5 Email

The email interface is shown as in Figure 5-37.

The screenshot shows the 'Email' configuration page. At the top, there is a title bar 'Email'. Below it, there are several sections of controls:

- Enable:** A checkbox that is currently unchecked.
- SMTP Server:** A text input field containing 'MailServer'.
- Port:** A text input field containing '25', with a range '(1~65535)' to its right.
- Anonymous:** A checkbox that is currently unchecked.
- Username:** An empty text input field.
- Password:** An empty text input field.
- Sender:** An empty text input field.
- Encryption Type:** A dropdown menu set to 'NONE'.
- Subject:** A text input field containing 'NVR ALERT', followed by a checked checkbox labeled 'Attachment'.
- Receiver:** A large text input area with '+' and '-' buttons on the right side.
- Interval:** A text input field containing '120', with 'Sec. (0~3600)' to its right.
- Health Enable:** A text input field containing '60', with 'Min. (30~1440)' to its right.

At the bottom of the form, there are four buttons: 'Email Test', 'OK', 'Refresh', and 'Default'.

Figure 5-37

Please refer to the following sheet for detailed information.

Parameter	Function
Enable	Please check the box here to enable email function.
SMTP Server	Input server address and then enable this function.

Parameter	Function
Port	Default value is 25. You can modify it if necessary.
Anonymous	For the server supports the anonymity function. You can auto login anonymously. You do not need to input the user name, password and the sender information.
Username	The user name of the sender email account.
Password	The password of sender email account.
Sender	Sender email address.
Encryption Type	You can select SSL or none.
Subject	Input email subject here.
Attachment	System can send out the email of the snapshot picture once you check the box here.
Receiver	Input receiver email address here. Max three addresses. It supports SSL, TLS email box.
Interval	The send interval ranges from 0 to 3600 seconds. 0 means there is no interval. Please note system will not send out the email immediately when the alarm occurs. When the alarm, motion detection or the abnormality event activates the email, system sends out the email according to the interval you specified here. This function is very useful when there are too many emails activated by the abnormality events, which may result in heavy load for the email server.
Health Enable	Please check the box here to enable this function.
Email test	The system will automatically sent out a email once to test the connection is OK or not .Before the email test, please save the email setup information.

### 5.11.2.6 UPnP

It allows you to establish the mapping relationship between the LAN and the public network.

Here you can also add, modify or remove UPnP item. See Figure 5-38.

- In the Windows OS, From Start>Control Panel>Add or remove programs. Click the “Add/Remove Windows Components” and then select the “Network Services” from the Windows Components Wizard.
- Click the Details button and then check the “Internet Gateway Device Discovery and Control client” and “UPnP User Interface”. Please click OK to begin installation.
- Enable UPnP from the Web. If your UPnP is enabled in the Windows OS, the NVR can auto detect it via the “My Network Places”

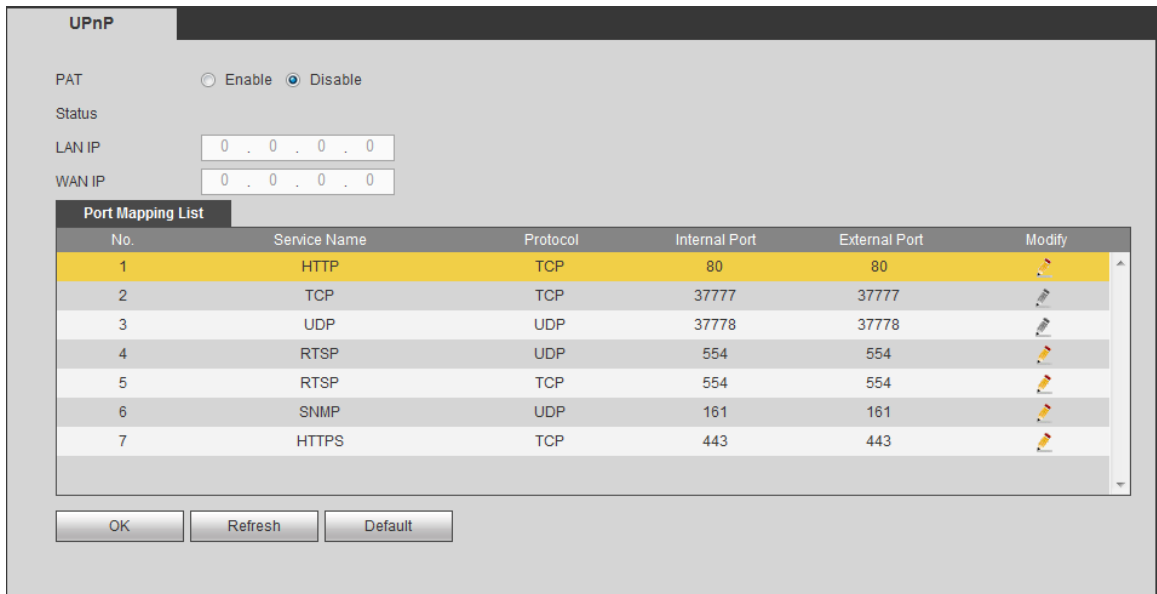

Figure 5-38

Please refer to the following sheet for detailed information.

Parameter	Function
PAT	Check the corresponding box to enable PAT function.
LAN IP	The LAN port address of the router. <b>Note</b> After the mapping is successful, the IP address will be obtained automatically, and no setting is required.
WAN IP	The WAN port address of the router. <b>Note</b> After the mapping is successful, the IP address will be obtained automatically, and no setting is required.
Status	Display UPnP function status.
Port mapping list	It is corresponding to the UPnP mapping information on the router. Check the box before the service name to enable current PAT service. Otherwise, the service is null. <ul style="list-style-type: none"> <li>• Service name: Customized name.</li> <li>• Protocol: Protocol type.</li> <li>• Internal port: The port mapped to the port.</li> <li>• External port: The port current device needs to map.</li> <li>• Device has three mapping items: HTTP/TCP/UDP.</li> </ul> <b>Note</b> When you set the external port (outport) of the router, the value ranges from 1024 to 5000. Do not use port 1–255 or system port 256–1023, in case there is conflict.
Modify	Click  to modify the corresponding external port number.

## 5.11.2.7 SNMP

The SNMP interface is shown as in Figure 5-39.

The SNMP allows the communication between the network management work station software and the proxy of the managed device. It is reserved for the 3<sup>rd</sup> party to develop.

The image shows a web-based configuration interface for SNMP. At the top, there is a tab labeled 'SNMP'. Below it, there is a checkbox for 'Enable' which is currently unchecked. Underneath, there are two checked checkboxes for 'Version', labeled 'V1' and 'V2'. The main configuration area consists of several input fields: 'SNMP Port' with the value '161' and a range indicator '(1~65535)'; 'Read Community' with the value 'public'; 'Write Community' with the value 'private'; 'Trap Address' which is an empty field; and 'Trap Port' with the value '162' and a range indicator '(1~65535)'. At the bottom of the form, there are three buttons: 'OK', 'Refresh', and 'Default'.

Figure 5-39

Please refer to the following sheet for detailed information.

Parameter	Function
SNMP Port	The listening port of the proxy program of the device. It is a UDP port not a TCP port. The value ranges from 1 to 65535. The default value is 161
Read Community	It is a string. It is a command between the manage process and the proxy process. It defined the authentication, access control and the management relationship between one proxy and one group of the managers. Please make sure the device and the proxy are the same. The read community will read all the objects the SNMP supported in the specified name. The default setup is public.
Write Community	It is a string. It is a command between the manage process and the proxy process. It defined the authentication, access control and the management relationship between one proxy and one group of the managers. Please make sure the device and the proxy are the same. The read community will read/write/access all the objects the SNMP supported in the specified name. The default setup is write.
Trap address	The destination address of the Trap information from the proxy program of the device.
Trap port	The destination port of the Trap information from the proxy program of the device. It is for the gateway device and the client-end PC in the LAN to exchange the information. It is a non-protocol connection port. It has no effect on the network applications. It is a UDP port not TCP port. The value ranges from 1 to 165535. The default value is 162.

Parameter	Function
SNMP version	<ul style="list-style-type: none"> <li>● Check V1, system only processes the information of V1.</li> <li>● Check V2, system only processes the information of V2.</li> </ul>

### 5.11.2.8 Multicast

The multicast interface is shown as in Figure 5-40.

Multicast is a transmission mode of data packet. When there is multiple-host to receive the same data packet, multiple-cast is the best option to reduce the broad width and the CPU load. The source host can just send out one data to transit. This function also depends on the relationship of the group member and group of the outer.

Figure 5-40

### 5.11.2.9 Auto Register

The auto register interface is shown as below. See Figure 5-41.

This function allows the device to auto register to the proxy you specified. In this way, you can use the client-end to access the NVR and etc via the proxy. Here the proxy has a switch function. In the network service, device supports the server address of IPv4 or domain.

Please follow the steps listed below to use this function.

Please set proxy server address, port, and sub-device name at the device-end. Please enable the auto register function, the device can auto register to the proxy server.

Figure 5-41

### 5.11.2.10 Alarm Centre

The alarm center interface is shown as below. See Figure 5-42.

This interface is reserved for you to develop. System can upload alarm signal to the alarm center when local alarm occurs.

Before you use alarm center, please set server IP, port and etc. When an alarm occurs, system can send out data as the protocol defined, so the client-end can get the data.

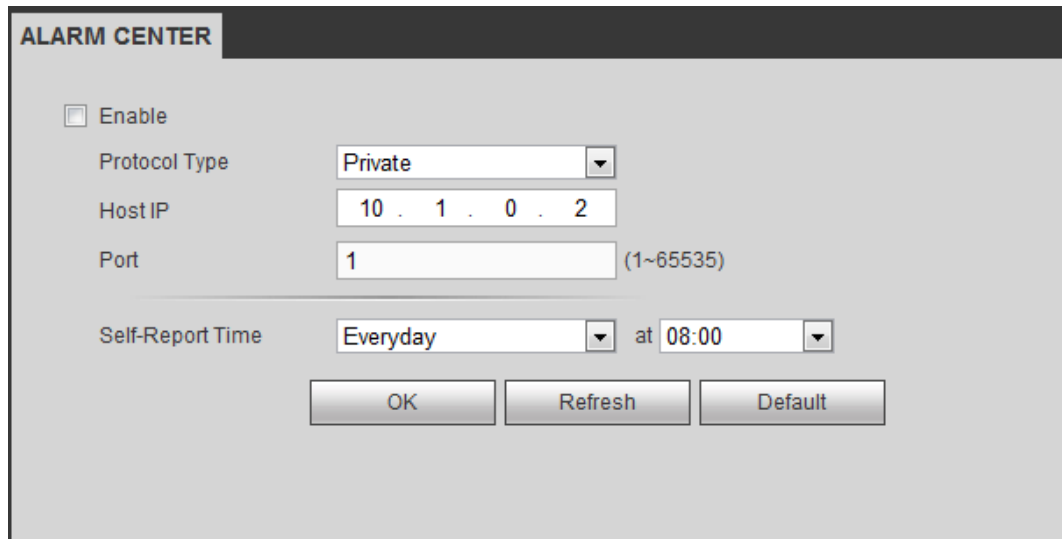

The screenshot shows the 'ALARM CENTER' configuration window. It features a header bar with the title 'ALARM CENTER'. Below the header, there is a checkbox labeled 'Enable'. Underneath, there are several configuration fields: 'Protocol Type' is a dropdown menu set to 'Private'; 'Host IP' is a text input field containing '10 . 1 . 0 . 2'; 'Port' is a text input field containing '1' with a range '(1~65535)' to its right; and 'Self-Report Time' is a dropdown menu set to 'Everyday' followed by 'at 08:00' with a time selection dropdown. At the bottom of the form, there are three buttons: 'OK', 'Refresh', and 'Default'.

Figure 5-42

### 5.11.2.11 HTTPS

In this interface, you can set to make sure the PC can successfully login via the HTTPS. It is to guarantee communication data security. The reliable and stable technology can secure the user information security and device safety. See Figure 5-43.

#### Note

- You need to implement server certificate again if you have changed device IP.
- You need to download root certificate if it is your first time to use HTTPS on current PC.

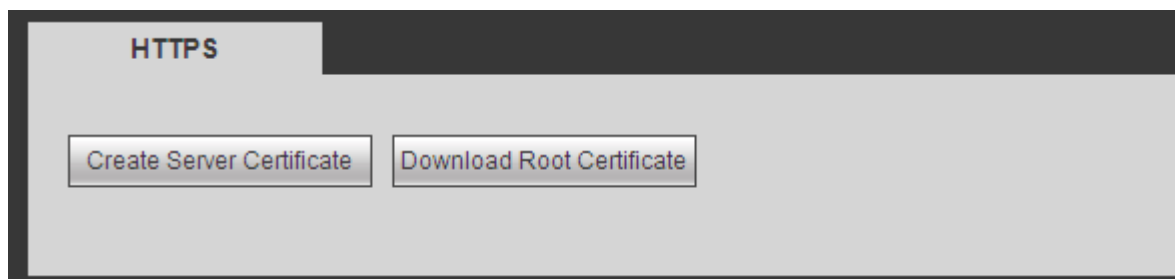

The screenshot shows the 'HTTPS' configuration window. It has a header bar with the title 'HTTPS'. Below the header, there are two buttons: 'Create Server Certificate' and 'Download Root Certificate'.

Figure 5-43

#### 5.11.2.11.1 Create Server Certificate

If it is your first time to use this function, please follow the steps listed below.

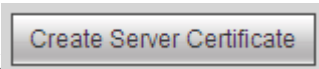

In Figure 5-43, click  button, input country name, state name and etc. Click Create button. See Figure 5-44.

**Note**

Please make sure the IP or domain information is the same as your device IP or domain name.

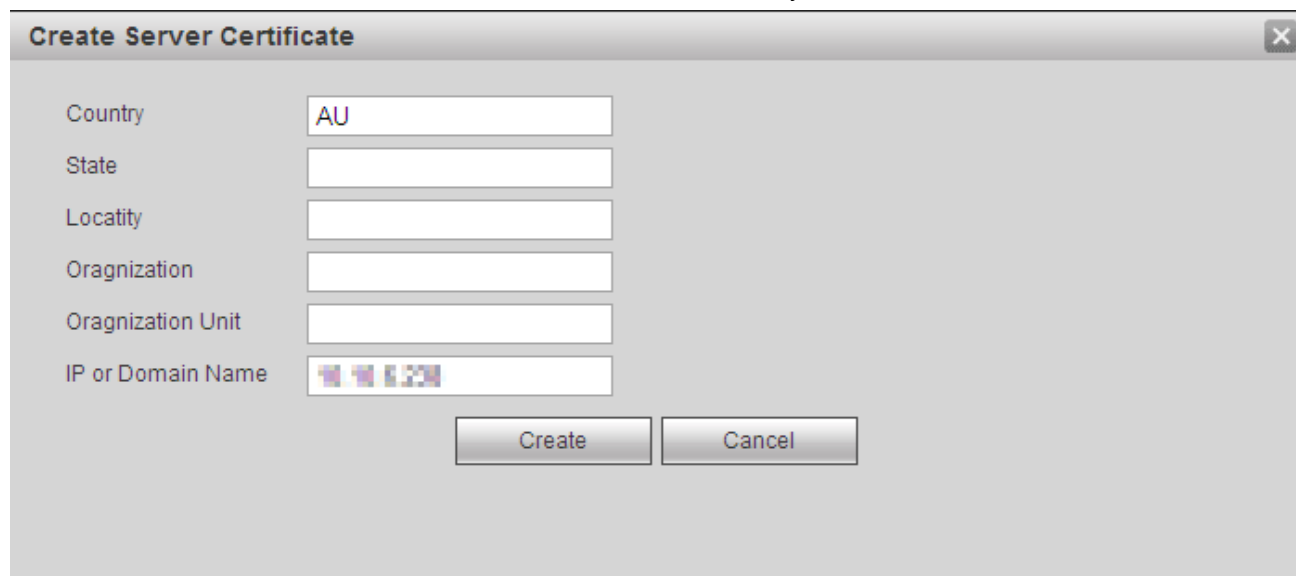

Figure 5-44

You can see the corresponding prompt. See Figure 5-45. Now the server certificate is successfully created.



Figure 5-45

**5.11.2.11.2 Download root certificate**

In Figure 5-43, click  button, system pops up a dialogue box. See Figure 5-46.



Figure 5-46

Click Open button, you can go to the following interface. See Figure 5-47.

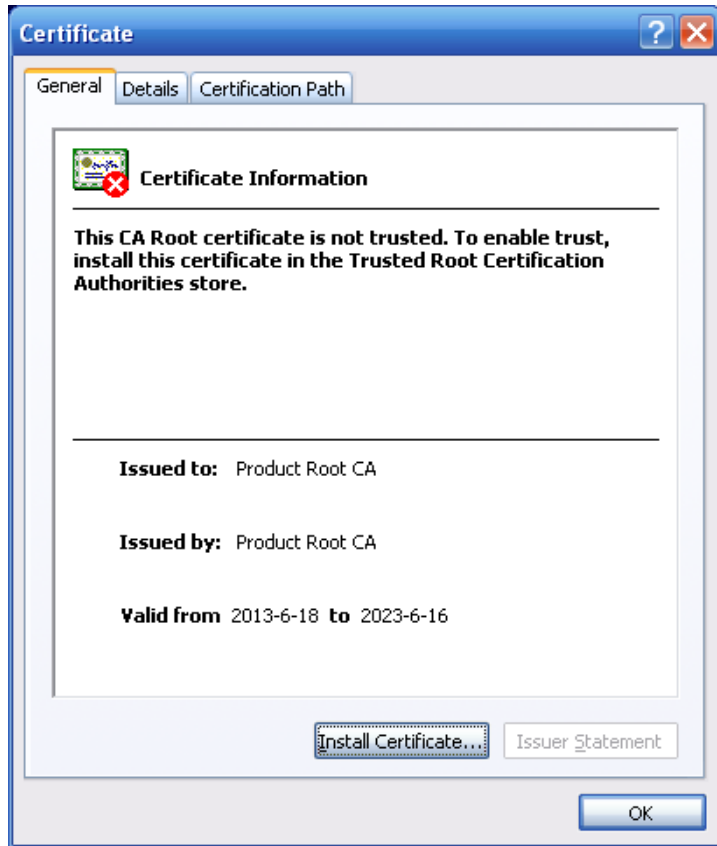

Figure 5-47

Click Install certificate button, you can go to certificate wizard. See Figure 5-48.



Figure 5-48

Click Next button to continue. Now you can select a location for the certificate. See Figure 5-49.

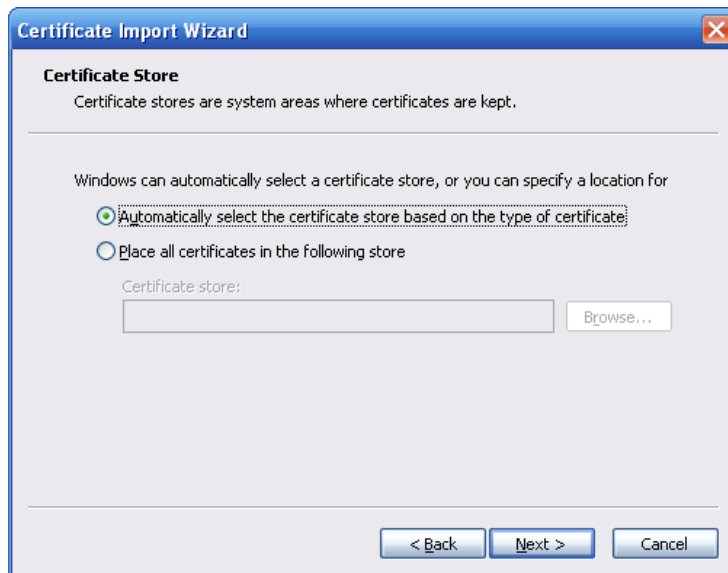

Figure 5-49

Click Next button, you can see the certificate import process is complete. See Figure 5-50.

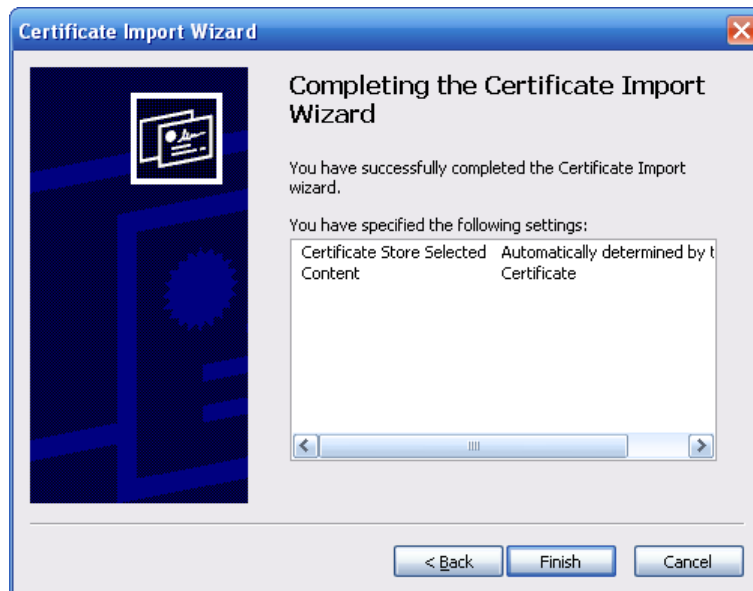

Figure 5-50

Click Finish button, you can see system pops up a security warning dialogue box. See Figure 5-51.



Figure 5-51

Click Yes button, system pops up the following dialogue box, you can see the certificate download is complete. See Figure 5-52.



Figure 5-52

### 5.11.2.11.3 View and set HTTPS port

From Setup>Network>Connection, you can see the following interface. See Figure 5-53. You can see HTTPS default value is 443.

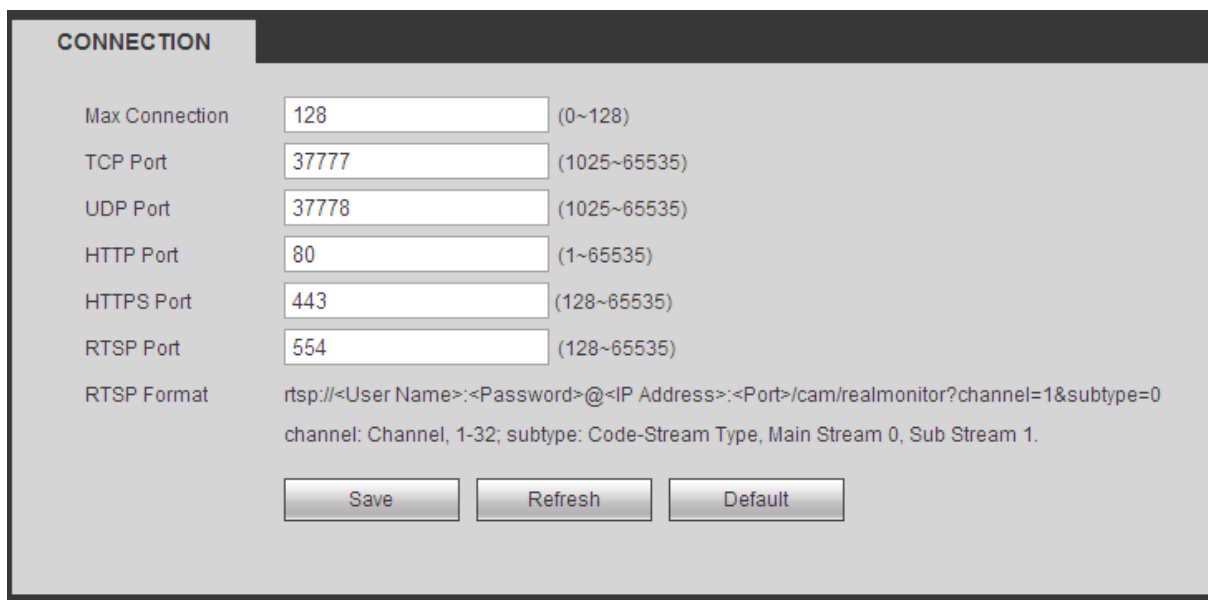

Figure 5-53

### 5.11.2.11.4 Login

Open the browser and then input <https://xx.xx.xx.xx:port>.

xx.xx.xx.xx: is your device IP or domain name.

Port is your HTTPS port. If you are using default HTTPS value 443, you do not need to add port information here. You can input <https://xx.xx.xx.xx> to access.

Now you can see the login interface if your setup is right.

### 5.11.2.12 P2P

You can use your cell phone to scan the QR code and add it to the cell phone client.

Via the SN from scanning the QR code, you can access the device in the WAN. Please refer to the P2P operation manual included in the resources CD.

The P2P interface is shown as in Figure 5-54.

Check the Enable box to enable P2P function and then click the Save button. Now you can view the device status and SN.

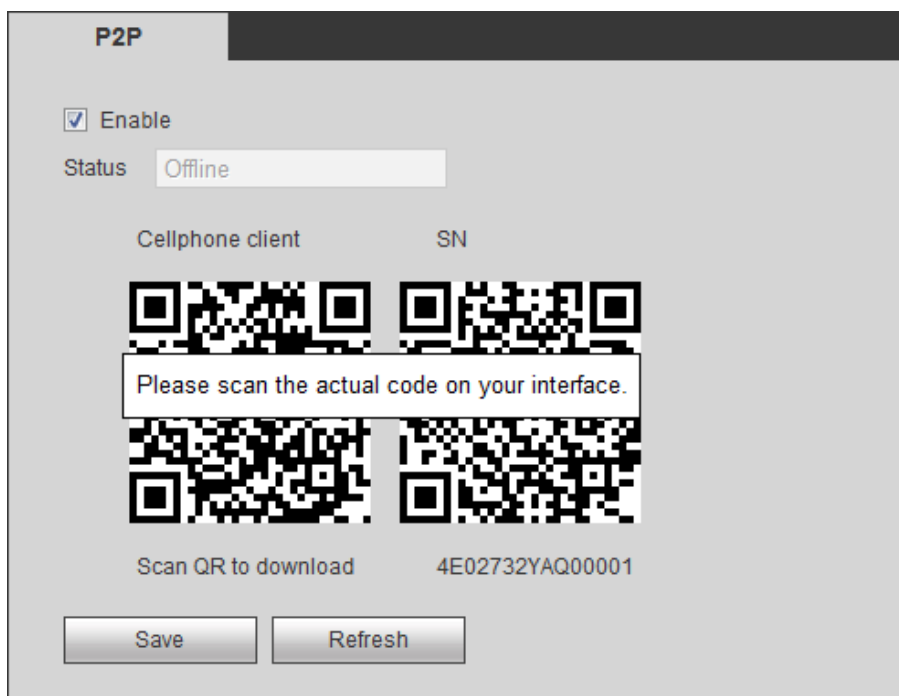

Figure 5-54

## 5.11.3 Event

### 5.11.3.1 Video detect

#### 5.11.3.1.1 Motion Detect

After analysis video, system can generate a video loss alarm when the detected moving signal reached the sensitivity you set here.

The motion detect interface is shown as in Figure 5-55.

**Motion Detect** | Video Loss | Tampering | Scene Change

Enable      D1

Period      Setup

Anti-Dither      5      Sec.(0-600)

Region      Setup

---

Record Channel      Setup

Post-Record      10      Sec.(10~300)

Alarm Out      1 2 3 4 5 6

Latch      10      Sec.(0~300)

PTZ Activation      Setup

Tour      Setup

Snapshot      Setup

Voice Prompts      File N... None

Show Message       Send...     Alarm...     Buzzer     Log

Copy      OK      Refresh      Default

Figure 5-55

**Setup** [X]

Thursday [v]      Copy

<input checked="" type="checkbox"/>	00 : 00	-	24 : 00
<input type="checkbox"/>	00 : 00	-	24 : 00
<input type="checkbox"/>	00 : 00	-	24 : 00
<input type="checkbox"/>	00 : 00	-	24 : 00
<input type="checkbox"/>	00 : 00	-	24 : 00
<input type="checkbox"/>	00 : 00	-	24 : 00

Save      Cancel

Figure 5-56

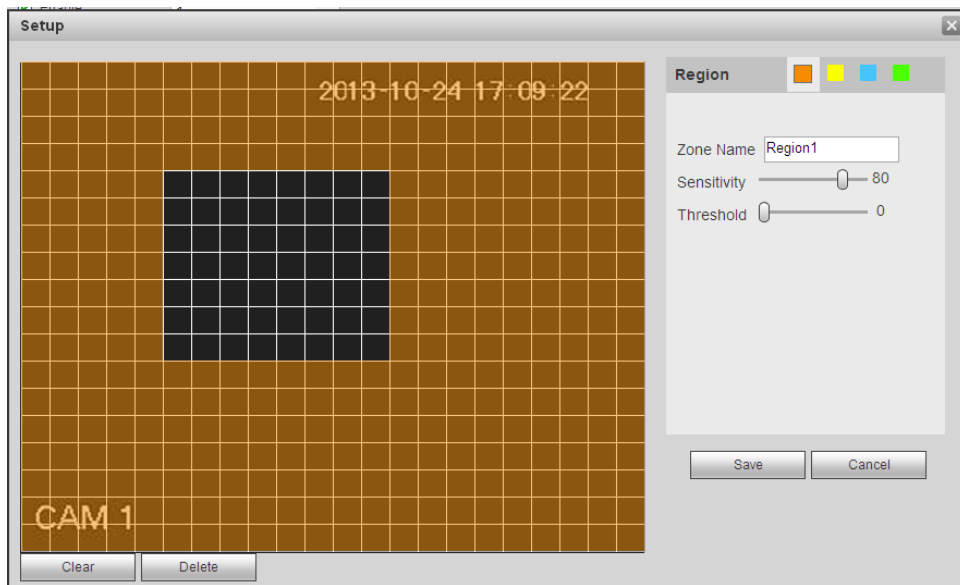

Figure 5-57

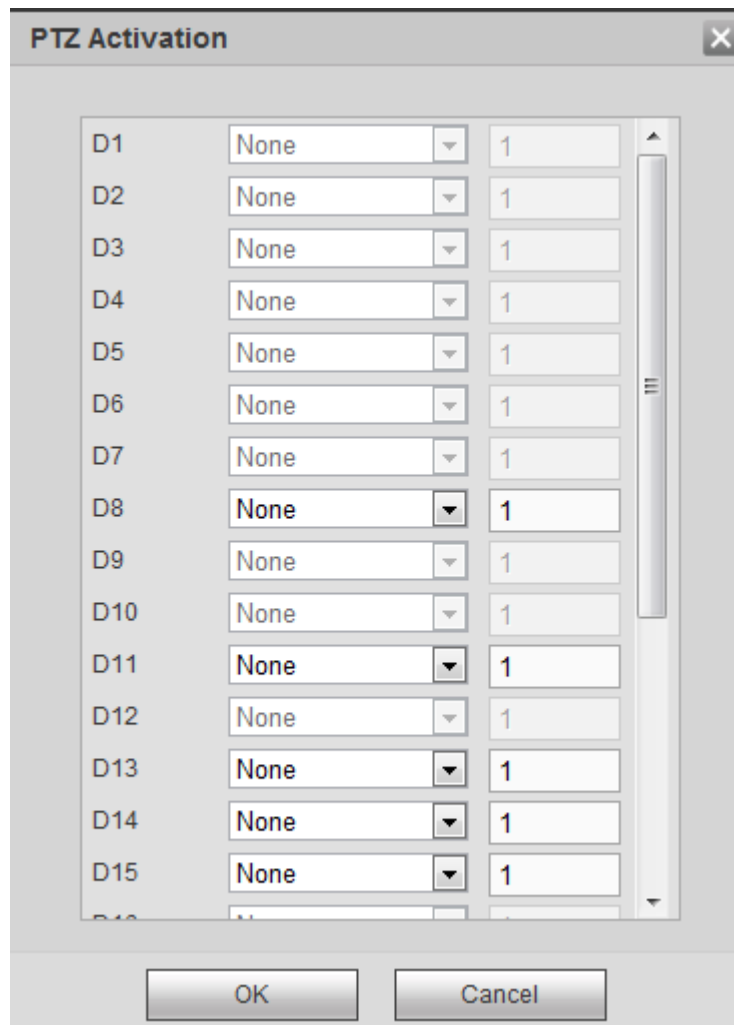

Figure 5-58

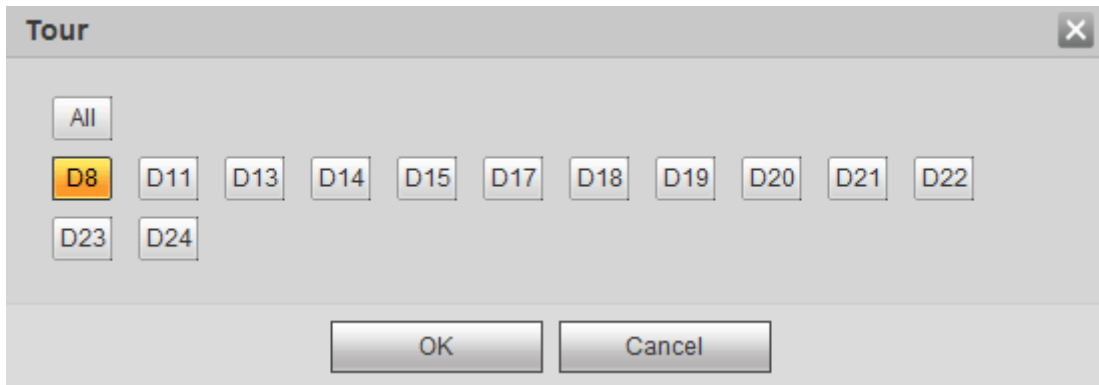

Figure 5-59

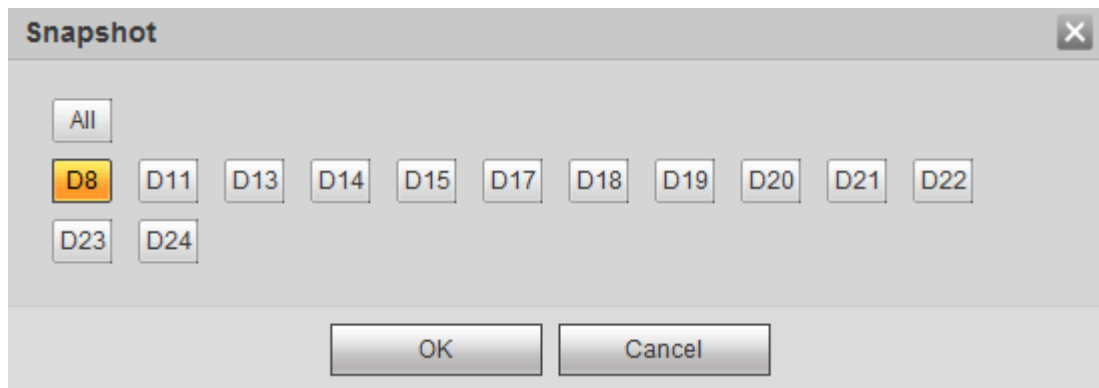

Figure 5-60

Please refer to the following sheet for detailed information.

Parameter	Function
Enable	You need to check the box to enable motion detection function. Please select a channel from the dropdown list.
Period	Motion detection function becomes activated in the specified periods. See Figure 5-56. There are six periods in one day. Please draw a circle to enable corresponding period. Click OK button, system goes back to motion detection interface, please click save button to exit.
Anti-dither	System only memorizes one event during the anti-dither period. The value ranges from 5s to 600s.
Sensitivity	There are six levels. The sixth level has the highest sensitivity.
Region	If you select motion detection type, you can click this button to set motion detection zone. The interface is shown as in Figure 5-57. Here you can set motion detection zone. There are four zones for you to set. Please select a zone first and then left drag the mouse to select a zone. The corresponding color zone displays different detection zone. You can click Fn button to switch between the arm mode and disarm mode. In arm mode, you can click the direction buttons to move the green rectangle to set the motion detection zone. After you completed the setup, please click ENTER button to exit current setup. Do remember click save button to save current



Parameter	Function
	setup. If you click ESC button to exit the region setup interface system will not save your zone setup.
Record channel	System auto activates motion detection channel(s) to record once an alarm occurs. Please note you need to set motion detect record period and go to Storage> Schedule to set current channel as schedule record.
Record Delay	System can delay the record for specified time after alarm ended. The value ranges from 10s to 300s.
Alarm out	Enable alarm activation function. You need to select alarm output port so that system can activate corresponding alarm device when an alarm occurs.
Latch	System can delay the alarm output for specified time after an alarm ended. The value ranges from 1s to 300s.
Show message	System can pop up a message to alarm you in the local host screen if you enabled this function.
Buzzer	Check the box here to enable this function. The buzzer beeps when an alarm occurs.
Alarm upload	System can upload the alarm signal to the center (Including alarm center).
Send Email	If you enabled this function, System can send out an email to alert you when an alarm occurs.
Tour	You need to click setup button to select tour channel. System begins 1-window or multiple-window tour display among the channel(s) you set to record when an alarm occurs. See Figure 5-59.
PTZ Activation	Here you can set PTZ movement when alarm occurs. Such as go to preset X. See Figure 5-58.
Snapshot	Click setup button to select snapshot channel. See Figure 5-60.
Video Matrix	This function is for motion detect only. Check the box here to enable video matrix function. Right now system supports one-channel tour function. System takes "first come and first serve" principle to deal with the activated tour. System will process the new tour when a new alarm occurs after previous alarm ended. Otherwise it restores the previous output status before the alarm activation.

### 5.11.3.1.2 Video Loss

The video loss interface is shown as in Figure 5-61.

Please note video loss does not support anti-dither, sensitivity, region setup. For rest setups, please refer to chapter 5.11.3.1.1 motion detect for detailed information.

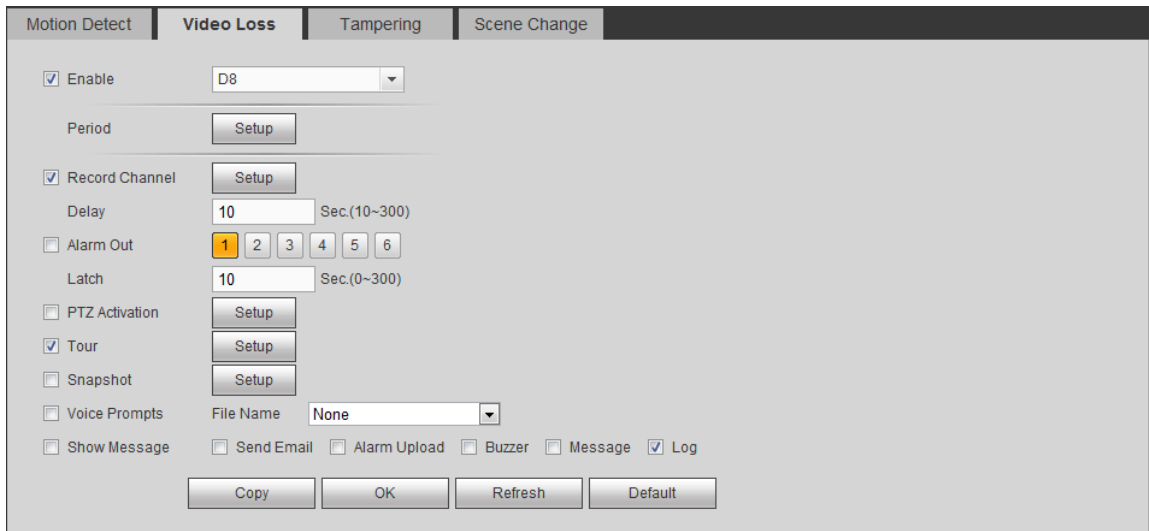

Figure 5-61

### 5.11.3.1.3 Tampering

The tampering interface is shown as in Figure 5-62.

After analysis video, system can generate a tampering alarm when the detected moving signal reached the sensitivity you set here.

For detailed setups, please refer to chapter 5.11.3.1.1 motion detect for detailed information.

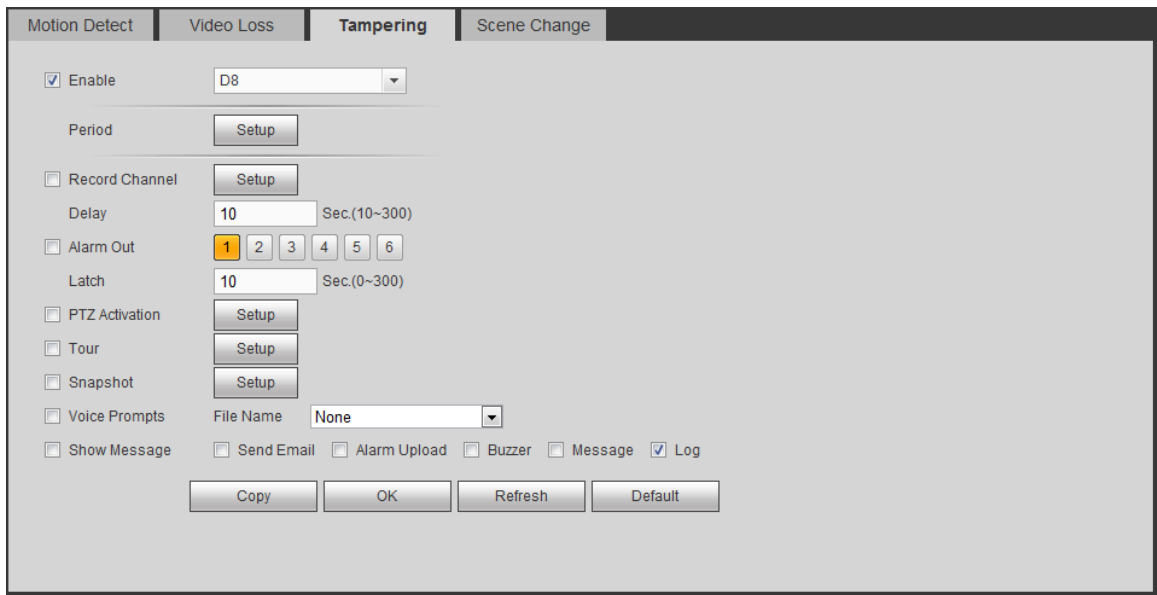

Figure 5-62

### 5.11.3.1.4 Scene Change

From main window>Setup>Event>Video detect>Scene change, the video diagnosis interface is shown as in Figure 5-63.

Figure 5-63

For detailed setups, please refer to chapter 5.11.3.1.1 motion detect for detailed information.

### 5.11.3.2 IVS Plan

The smart plan is for the smart network camera. If you do not set a rule here, you cannot use the intelligent functions in IVS (Chapter 5.11.3.3), Face detection (Chapter 5.11.3.4) and People counting (Chapter 5.11.3.8) when you are connecting to a smart network camera.

There are two types to realize intelligent analytics function.



**Note**

- Smart network camera supports intelligent functions: Some smart camera supports the intelligent functions. For NVR, it just displays the intelligent alarm information from the smart network camera and set or playback the record file.
- NVR supports intelligent functions: The connected network camera does not support intelligent video analytics function. The NVR supports the analytics function.

From main menu>Setup>Event>IVS plan, you can go to the IVS plan interface. See Figure 5-64.

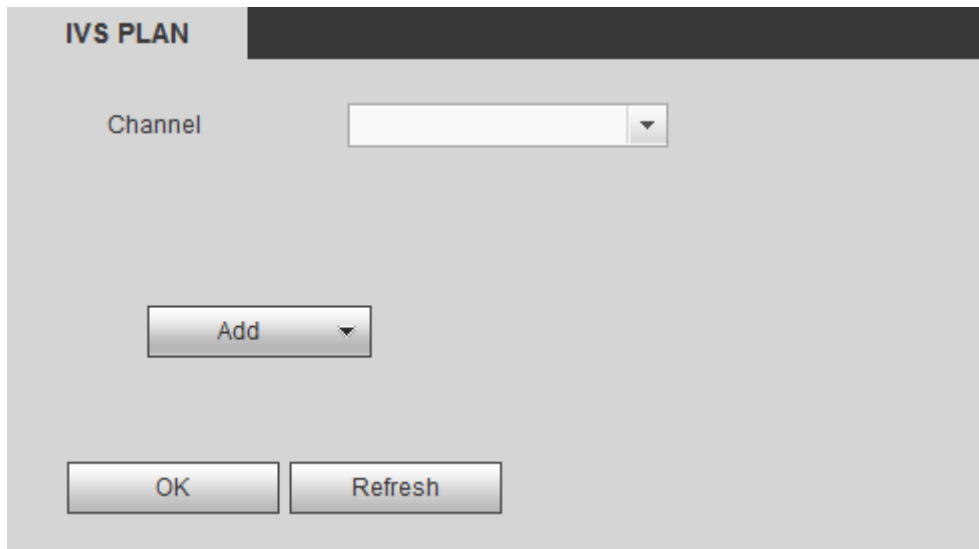

Figure 5-64

Select a channel from the dropdown list. Click Add button, you can see an interface shown as below. See Figure 5-65.

Select a channel from the dropdown list and then set preset. Click Add button and then set the corresponding rule.

 **Note**

Some smart camera does not need to add the preset. Please refer to the actual product for detailed information.

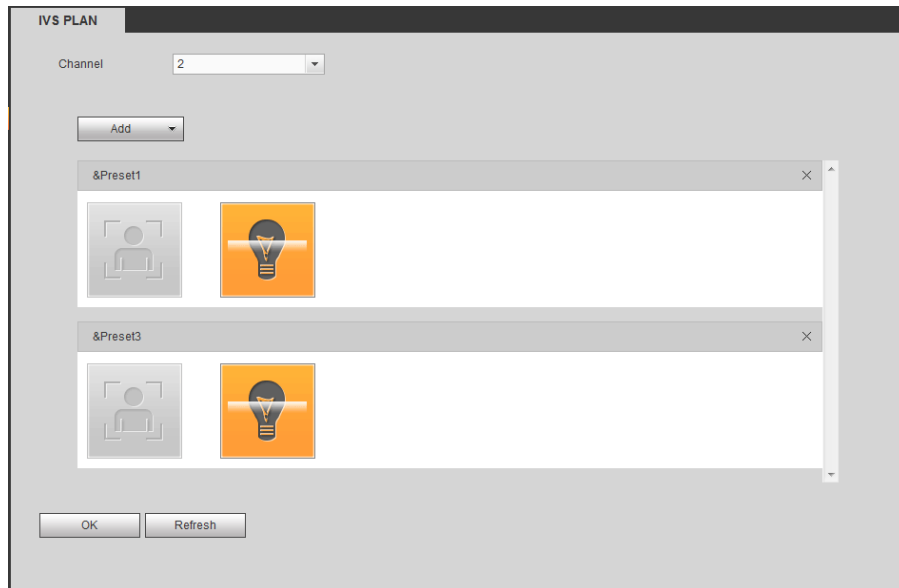

Figure 5-65

Click OK button to complete the setup.

 **Note**

- The NVR supports IVS, human face detection, heat map, and people counting. Different network camera supports different smart plans. Please refer to the actual product for detailed information.

- The IVS and human face detection function cannot be valid at the same time. For example, when add the IVS plan to the preset 1, the human face detection icon becomes grey.

### 5.11.3.3 IVS

IVS refers to extracting the key information in the video through image processing and analysis, and matching with the preset detection rules. When the detected behavior matches the detection rule, the system will generate an alarm and perform linkage action.



#### NOTE

- Only some devices support this function. See the actual situation.
- IVS function and face detection function are mutually exclusive.

System supports AI by camera and AI by device. When both functions are enabled at the same time, AI by device is preferred.

- IVS of AI by camera includes tripwire, intrusion, abandoned object, fast moving, missing object and global setup.
- IVS of AI by device includes tripwire and intrusion.

The scenario requirements of IVS are listed as follows:

- The total target ratio does not exceed 10% of the screen.
- The size of the target in the picture is not less than 10 pixels × 10 pixels, the target size of the abandoned object is not less than 15 pixels × 15 pixels (CIF image); the target height and width is not more than 1/3 of the picture height and the recommended target height is 10% of the picture height.
- The difference between the brightness value of the target and the background is not less than 10 gray levels.
- At least ensure that the target appears continuously for more than 2 seconds in the field of view, the moving distance exceeds the target's own width, and is not less than 15 pixels (CIF image).
- Minimize the complexity of the monitoring and analysis scenario when conditions permit. It is not recommended to use the smart analysis function in scenarios with dense targets and frequent light changes.
- Try to avoid areas such as glass, ground reflection and water surface; try to avoid branches, shadows and mosquito interference areas; try to avoid backlit scenes and avoid direct light.

Step 1 Select Setup > Event > IVS > IVS.

The IVS interface is displayed. See Figure 5-66.

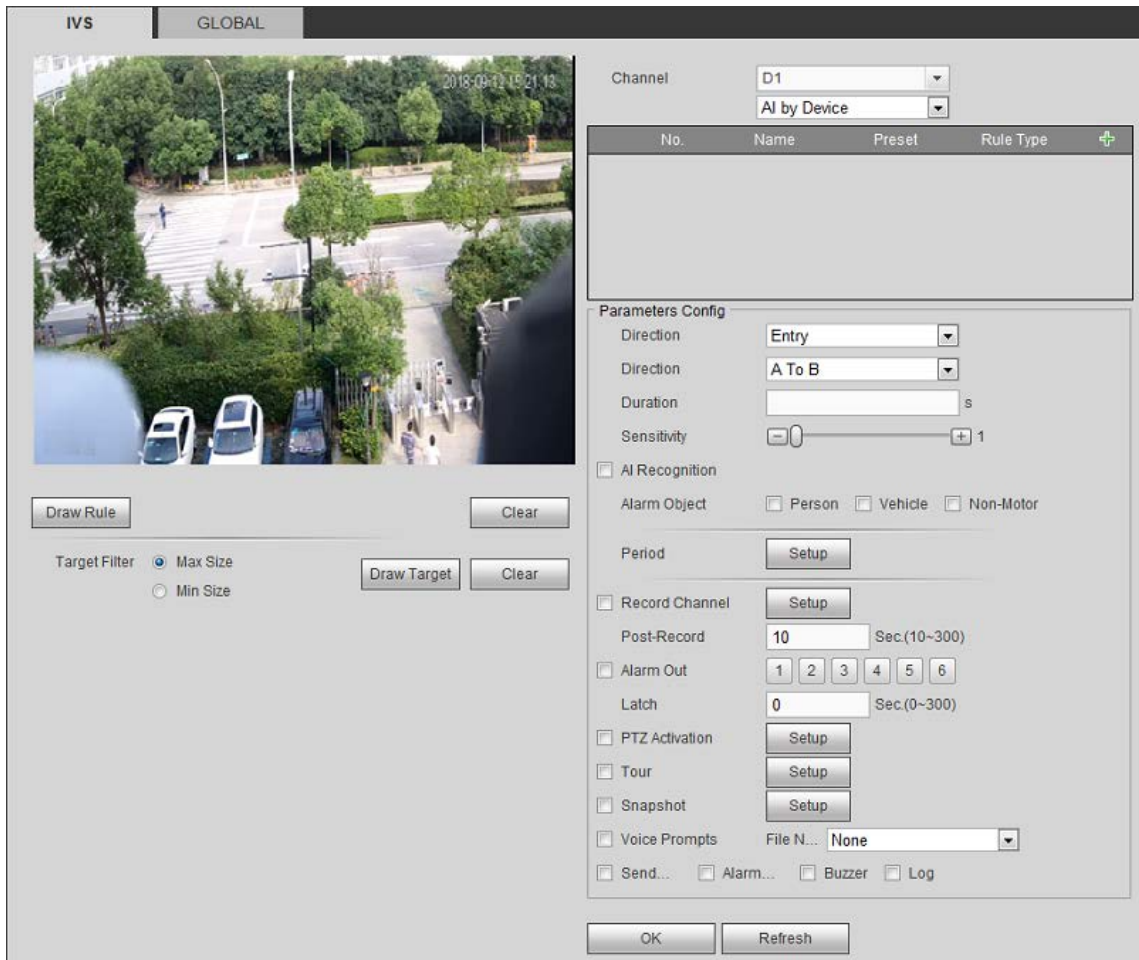

Figure 5-66

Step 2 Select the channel number.

Step 3 Select the AI type.

NOTE

Before AI by camera is enabled, the front end needs to access the intelligent IPC. Different smart IPCs support different functions.

Step 4 Click and select the corresponding rule type according to the actual needs. See Figure 5-67.

NOTE

Click to delete the corresponding rule.

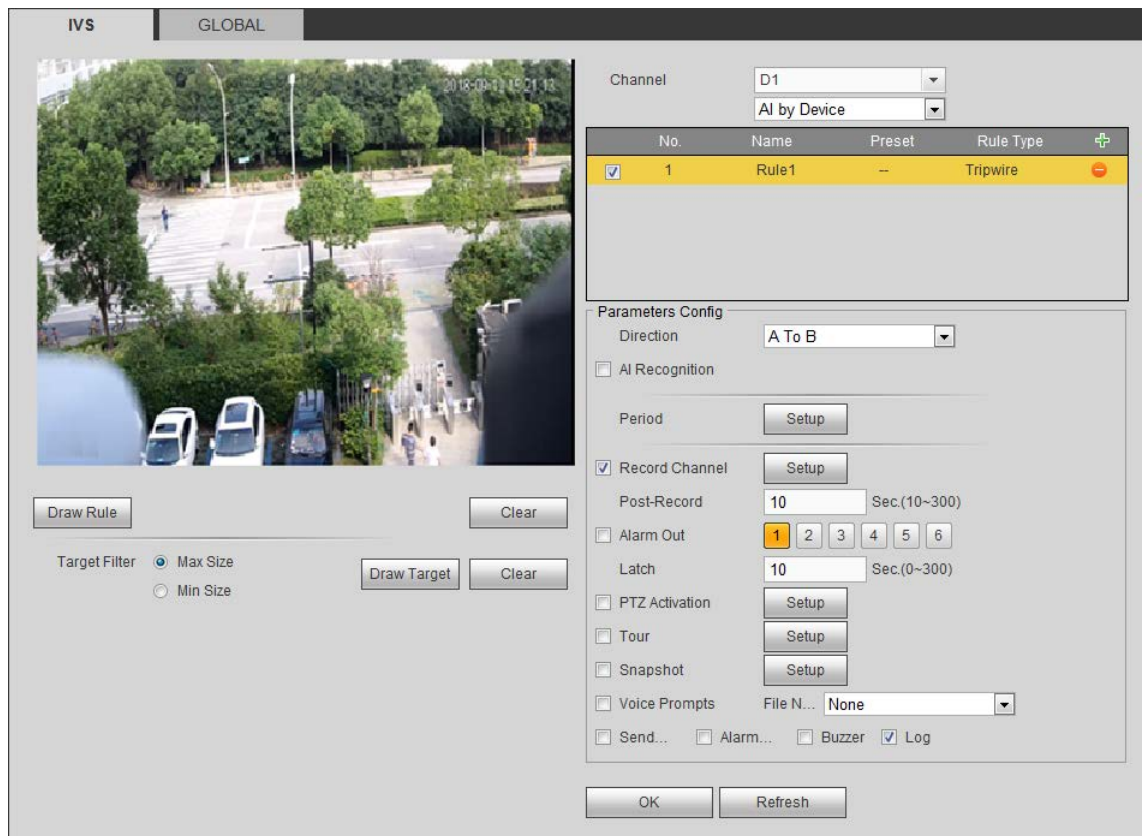

Figure 5-67

Step 5 Configure the parameters according to the rule type.

Step 6 Click OK to complete the setting.

### 5.11.3.3.1 Tripwire

When the detection target crosses the warning line along the set direction, the system performs an alarm linkage action

Step 1 In the Rule Type drop-down list, select Tripwire.

- When you select AI by camera, the system displays as Figure 5-68.
- When you select AI by device, the system displays as Figure 5-69.

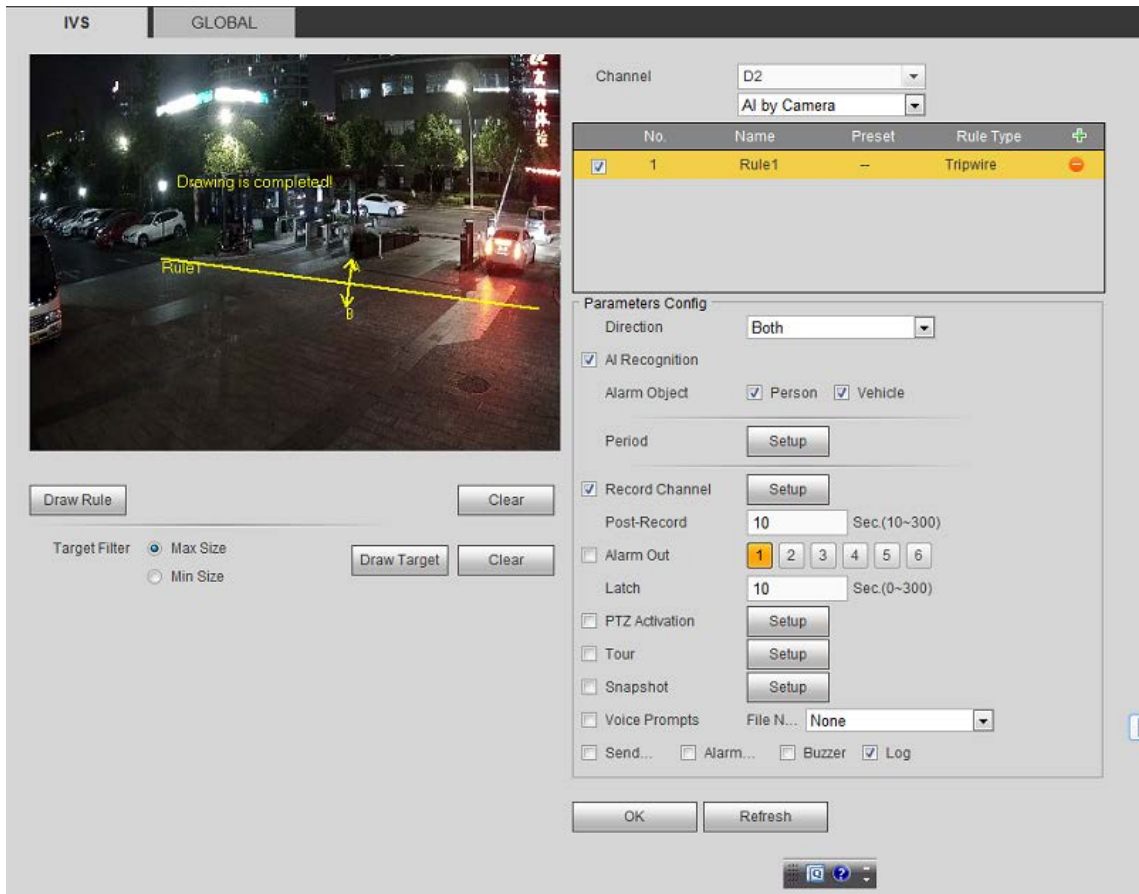

Figure 5-68

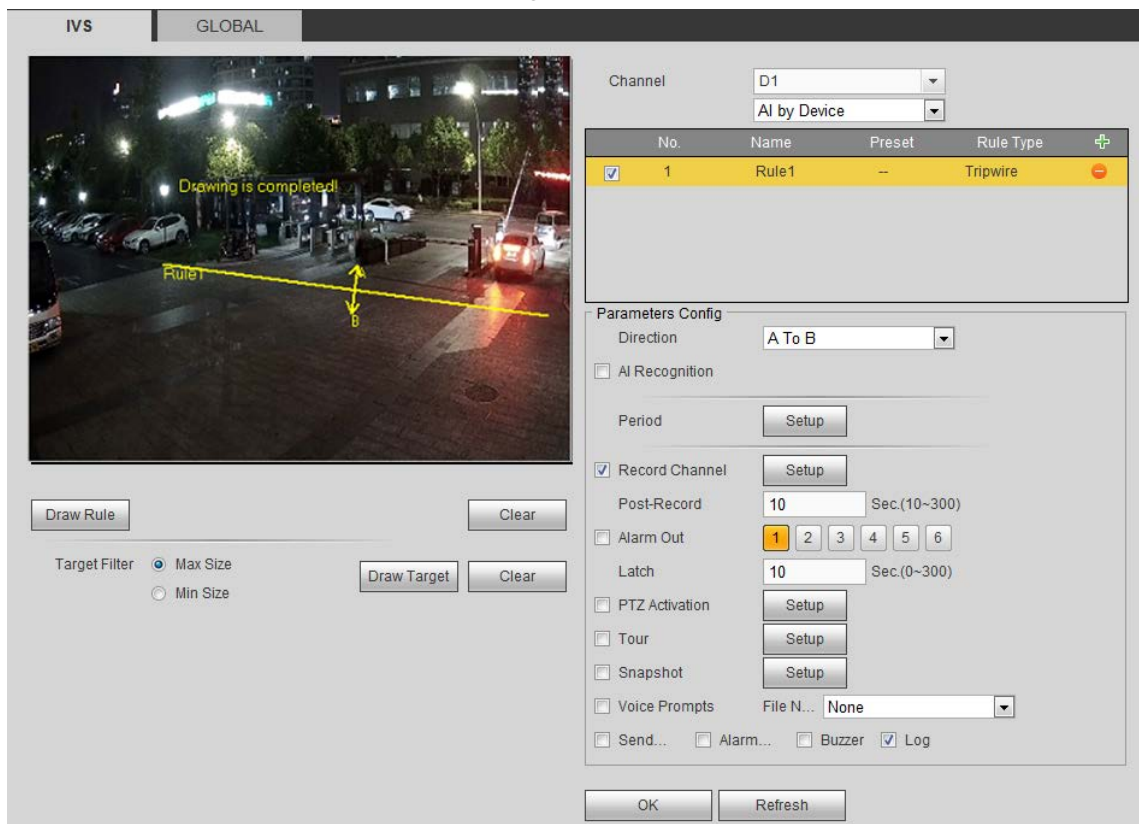











Figure 5-1 Figure 5-69

Step 2 Configure the parameters. For details, see the following table.

Parameter	Description
-----------	-------------



Parameter	Description
Draw Rule	Click Draw Rule to draw the appropriate rules in the monitor screen. Click Clear on the right side of Drawing Rule to delete the drawn rule.
Draw Target	<p>Click Draw Target to draw a size model of the filter target for this rule in the scene. Click Clear on the right of Draw Target to delete the target filtering model.</p> <p> NOTE</p> <p>Each rule can set 2 target filters (maximum size and minimum size), that is, when the passing target is smaller than the minimum target or larger than the maximum target, no alarm will be generated. The maximum size shall not be smaller than the minimum size.</p>
Direction	Set the tripwire direction, including A→B, B→A and A↔B.
AI Recognition	<p>Select the AI Recognition check box. The system supports identification of people and motor vehicles. When an alarm target appears in the monitoring screen, the system activates the corresponding linked alarm.</p> <p> NOTE</p> <p>When you select AI by camera, the front-end device shall support Perimeter Protection function. For details, see chapter 5.11.3.3.3 Perimeter Protection.</p>
Period	Configure the period and in the set time range, the corresponding configuration item will be linked to start the alarm.
Record Channel	<p>Select the check box and select the needed recording channel (support multiple choices). When an alarm occurs, the NVR device activates the channel for recording.</p> <p> NOTE</p> <p>You shall enable intelligent recording and auto recording first.</p>
Post-record	At the end of the alarm, the recording extends for a period of time. The time range is from 10 seconds to 300 seconds.
Alarm Out	The alarm device (such as lights, sirens, etc.) is connected to the alarm output port. When an alarm occurs, the NVR device transmits the alarm information to the alarm device.
Latch	When the alarm ends, the alarm extends for a period of time. The time range is from 0 seconds to 300 seconds.
PTZ Activation	<p>Select the check box and click Setting to select the channel and PTZ action. When an alarm occurs, the NVR device associates the channel to perform the corresponding PTZ action. For example, activate the PTZ in channel one to turn to the preset point X.</p> <p> NOTE</p> <ul style="list-style-type: none"> <li>• Tripwire alarm supports to activate PTZ preset point only.</li> <li>• You shall set the corresponding PTZ actions first.</li> </ul>

Parameter	Description
Tour	<p>Select the check box and select the channel for tour. When an alarm occurs, the local interface of the NVR device displays the selected channel screen.</p> <p> NOTE</p> <ul style="list-style-type: none"> <li>You shall set the time interval and mode for tour first.</li> <li>After the tour is over, the preview interface is restored to the screen split mode before the tour.</li> </ul>
Snapshot	<p>Select the check box and select the channel for snapshot. When an alarm occurs, the NVR device triggers the snapshot of the selected channel.</p> <p> NOTE</p> <p>You shall enable the intelligent snapshot and auto snapshot first.</p>
Voice Prompts	<p>Select the check box and select the corresponding voice file in the File Name drop-down box. When an alarm occurs, the system plays the voice file.</p> <p> NOTE</p> <p>You shall add the corresponding voice file first.</p>
Send Email	<p>Select the check box. When an alarm occurs, the NVR device sends an email to the set mailbox to notify the user.</p> <p> NOTE</p> <p>You shall set the email first.</p>
Alarm Upload	<p>Select the check box. When an alarm occurs, the NVR device uploads an alarm signal to the network (including the alarm center).</p> <p> NOTE</p> <ul style="list-style-type: none"> <li>Only some devices support this function. See the actual situation.</li> <li>You shall set the alarm center first.</li> </ul>
Buzzer	Select the check box to activate the buzzer when an alarm occurs.
Log	Select the check box, the NVR device records the alarm information in the log when an alarm occurs.

Step 3 Click OK to complete the setting.

### 5.11.3.3.2 Intrusion

When the detection target passes the edge of the monitoring area, and enters, leaves or traverses the monitoring area, the system performs an alarm linkage action.

Step 1 In the Rule Type drop-down list, select Intrusion.

- When you select AI by camera, the system displays as Figure 5-70.
- When you select AI by device, the system displays as Figure 5-71.

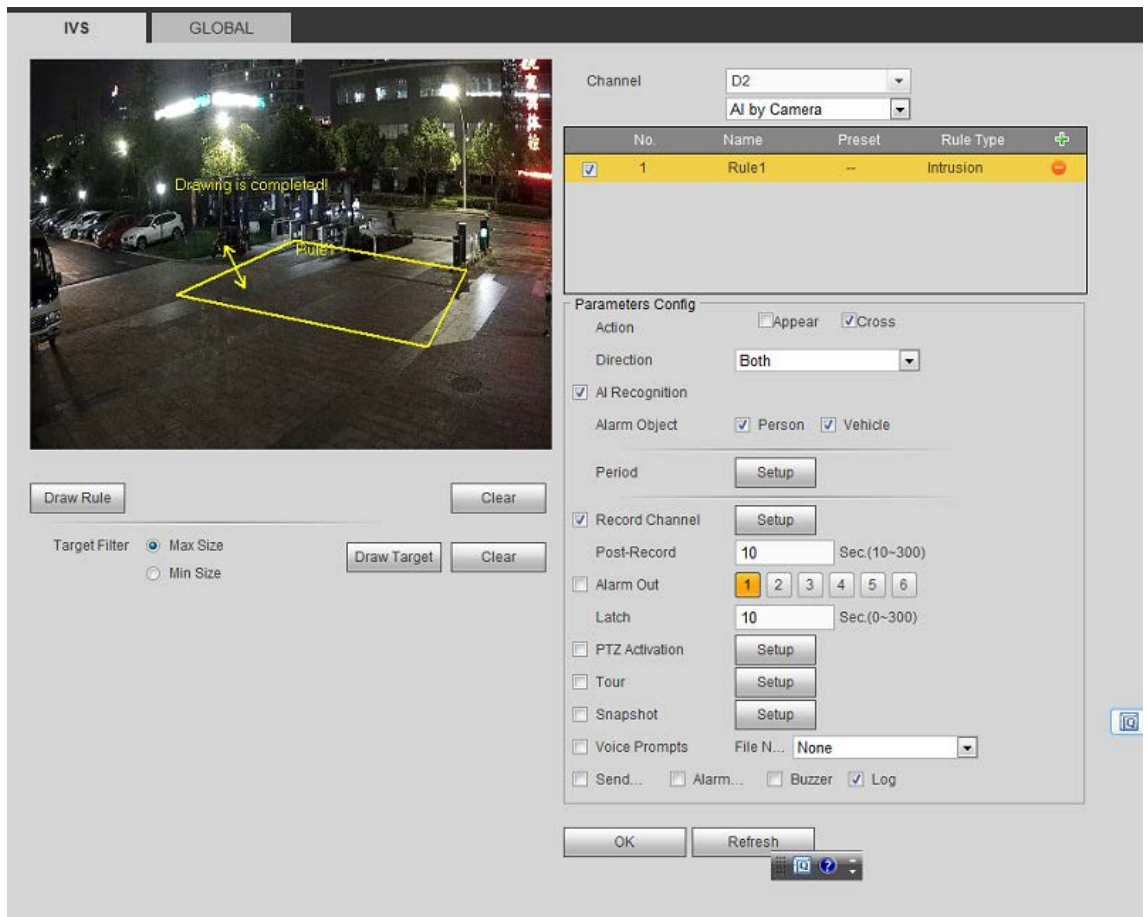

Figure 5-70

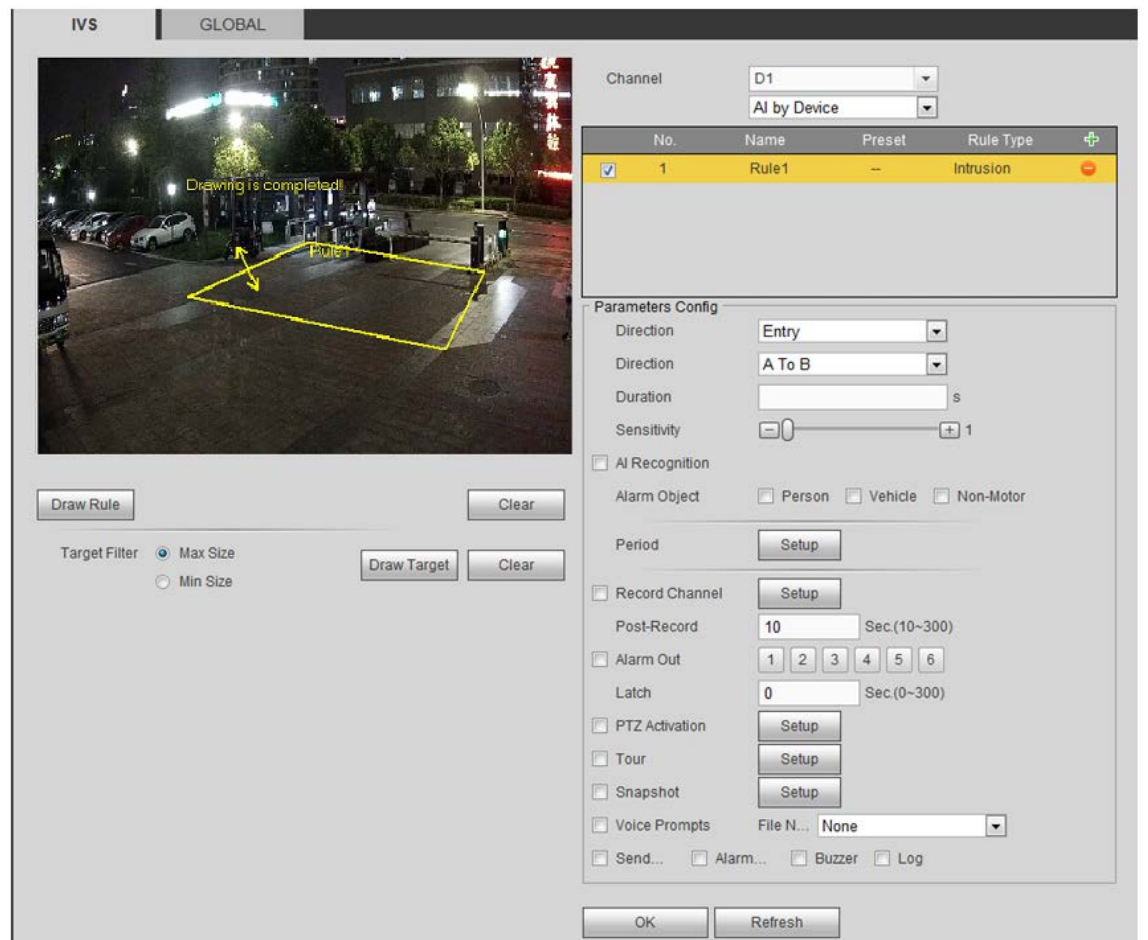

Figure 5-71

Step 2 Configure the parameters. For details, see table in chapter 5.11.3.3.1 Tripwire and the following table.

Parameter	Description
Action	Configure the intrusion action, including appear and crossing area.
Direction	Configure the direction of crossing area, including entry, exit and both.

Step 3 Click OK to complete the setting.

### 5.11.3.3.3 Perimeter Protection

The system supports perimeter protection detection for people and vehicles. When the detected behavior matches with the detection rule, system performs the linked alarm action.

Perimeter protection includes two functions: Tripwire and intrusion.

Step 1 Select Setup > Event > IVS > IVS.

The Perimeter Protection interface is displayed. See Figure 5-72.

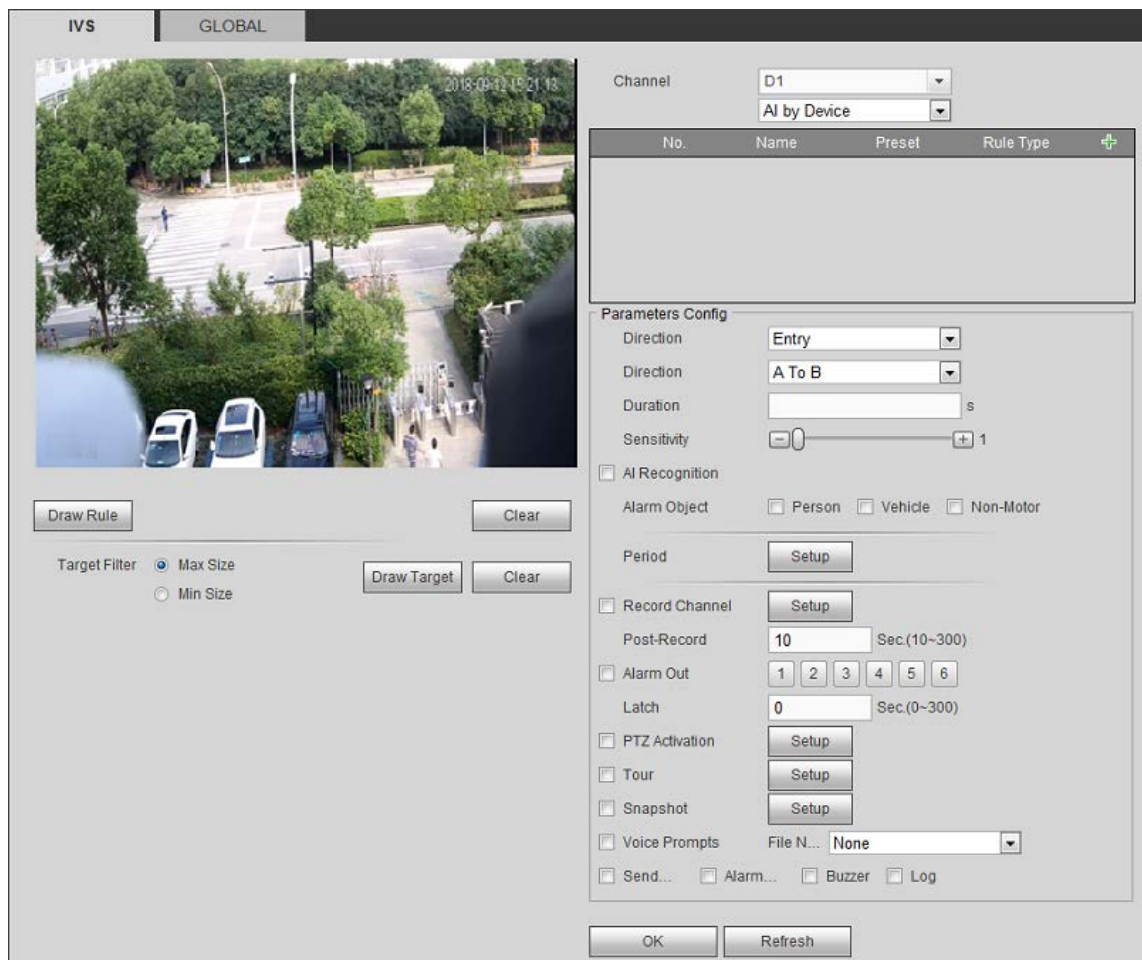



Figure 5-72

Step 2 Select the channel and AI type.

 NOTE

When you select AI by camera, the front-end device shall support perimeter protection function.

Step 3 Click  and select the rule type according to the actual needs. See Figure 5-73.

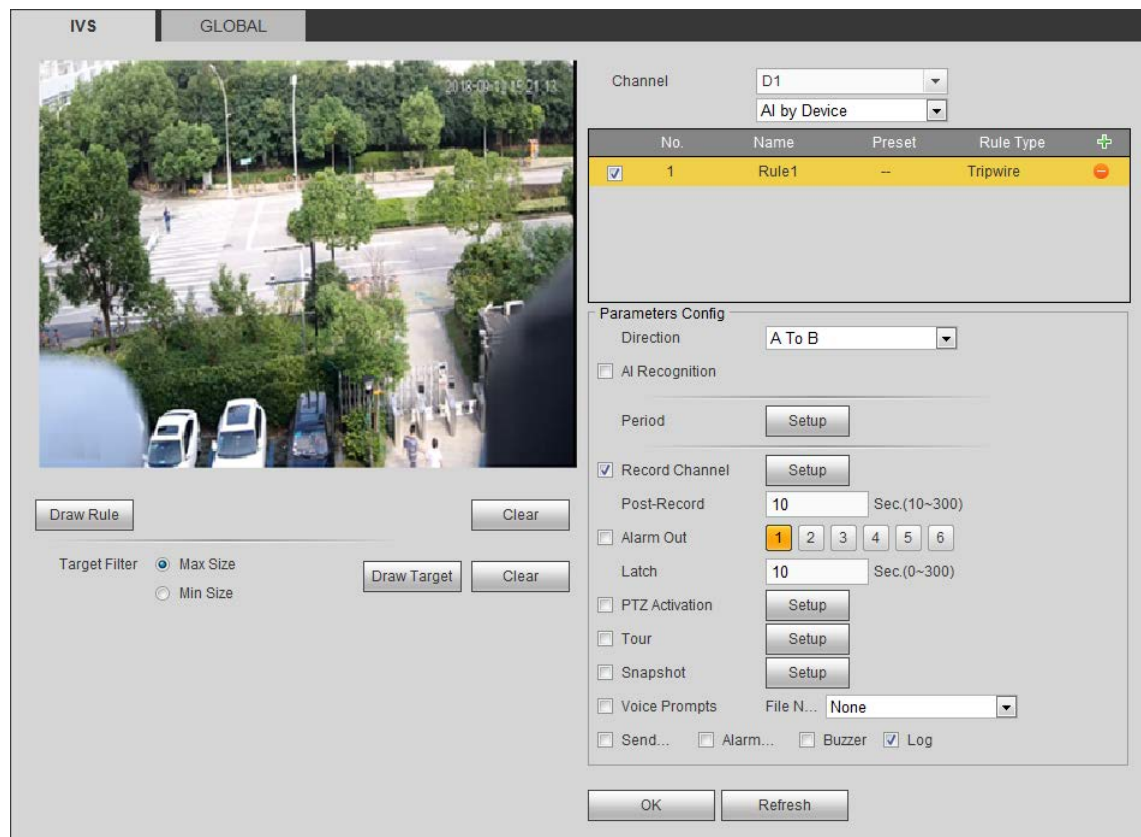

Figure 5-73

Step 4 Configure the relevant parameters according to the rule type. For parameter description, see chapter 5.11.3.3.1 Tripwire.

Step 5 Click OK to complete the setting.

#### 5.11.3.3.4 Abandoned Object

When the detection target stays in the monitoring area for more than the set duration, the system performs alarm linkage action.

Step 1 Select AI by Camera.

Step 2 In the drop-down list, select Abandoned. See Figure 5-74.

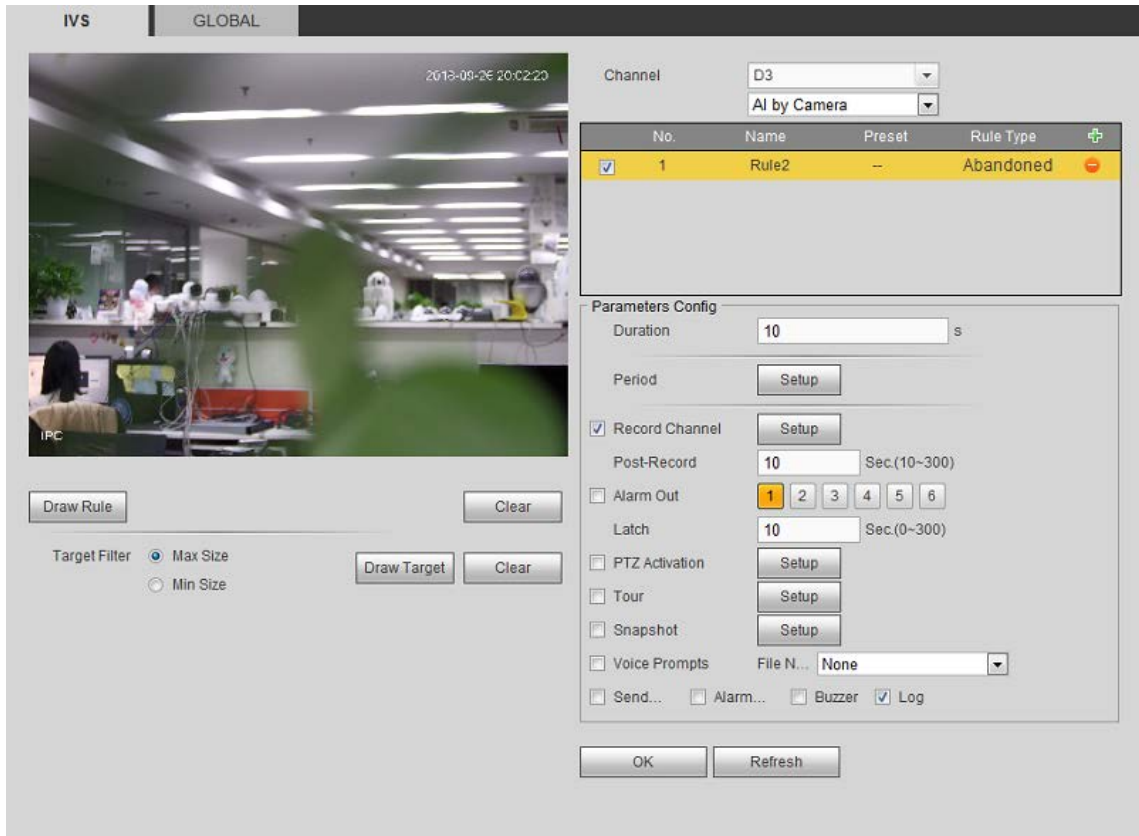

Figure 5-74

Step 3 Configure the parameters. For details, see chapter 5.11.3.3.1 Tripwire and the following table.

Parameter	Description
Duration	Set the minimum time that an object will remain until the alarm is triggered.

Step 4 Click OK to complete the setting.

### 5.11.3.3.5 Fast moving

When the moving speed of the detection target in the monitoring area reaches the set sensitivity, the system performs an alarm linkage action.

Step 1 Select AI by Camera.

Step 2 In the rule type drop-down list, select Fast Moving. See Figure 5-75.



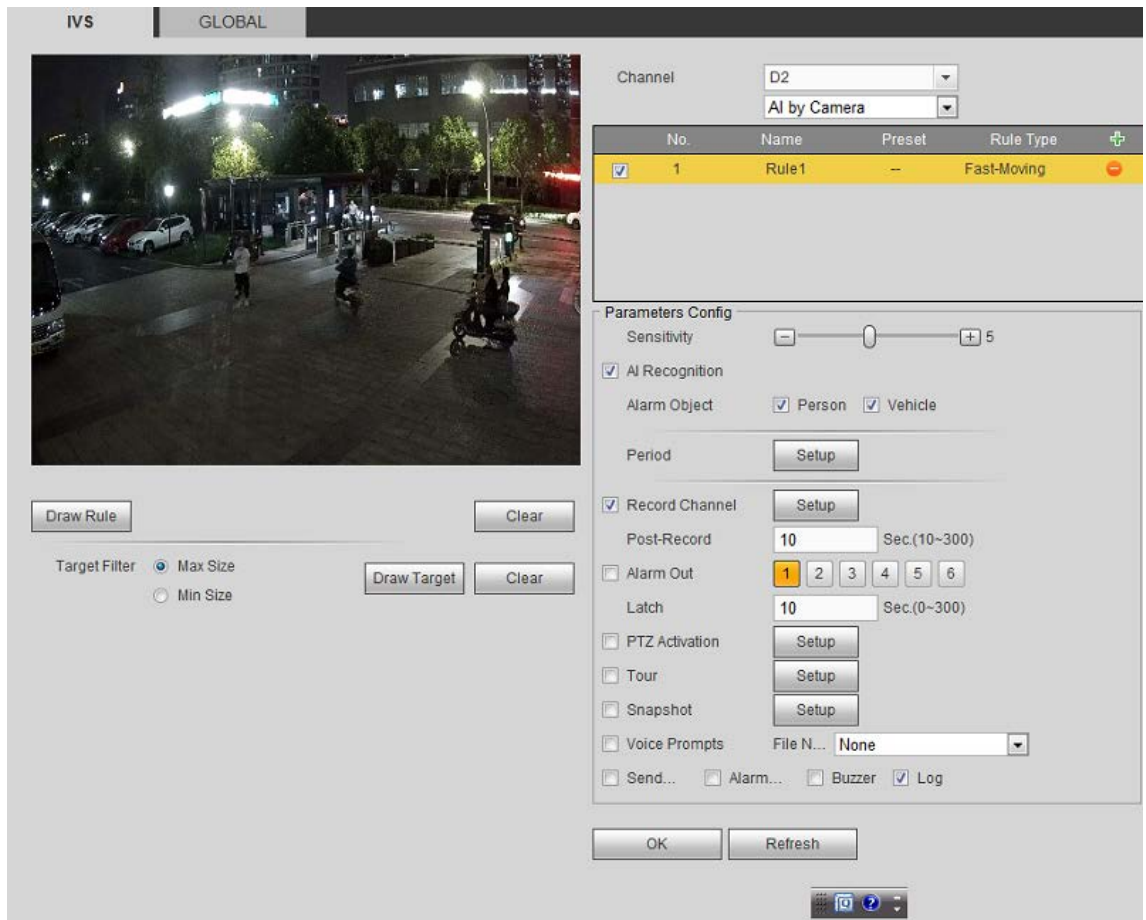

Figure 5-75

Step 3 Configure the parameters. For details, see chapter 5.11.3.3.1 Tripwire and the following table.

Parameter	Description
Sensitivity	Configure the sensitivity to trigger the alarm. System supports 1-10 and the default value is 5.

Step 4 Click OK to complete the setting.

### 5.11.3.3.6 Crowd Gathering

When the crowd gathering in the monitoring area is greater than the set minimum model, and the gathering time exceeds the set duration, the system performs an alarm linkage action.

Step 1 Select AI by Camera.

Step 2 In the Type drop-down list, select Crowd Gathering Estimation. See Figure 5-76.

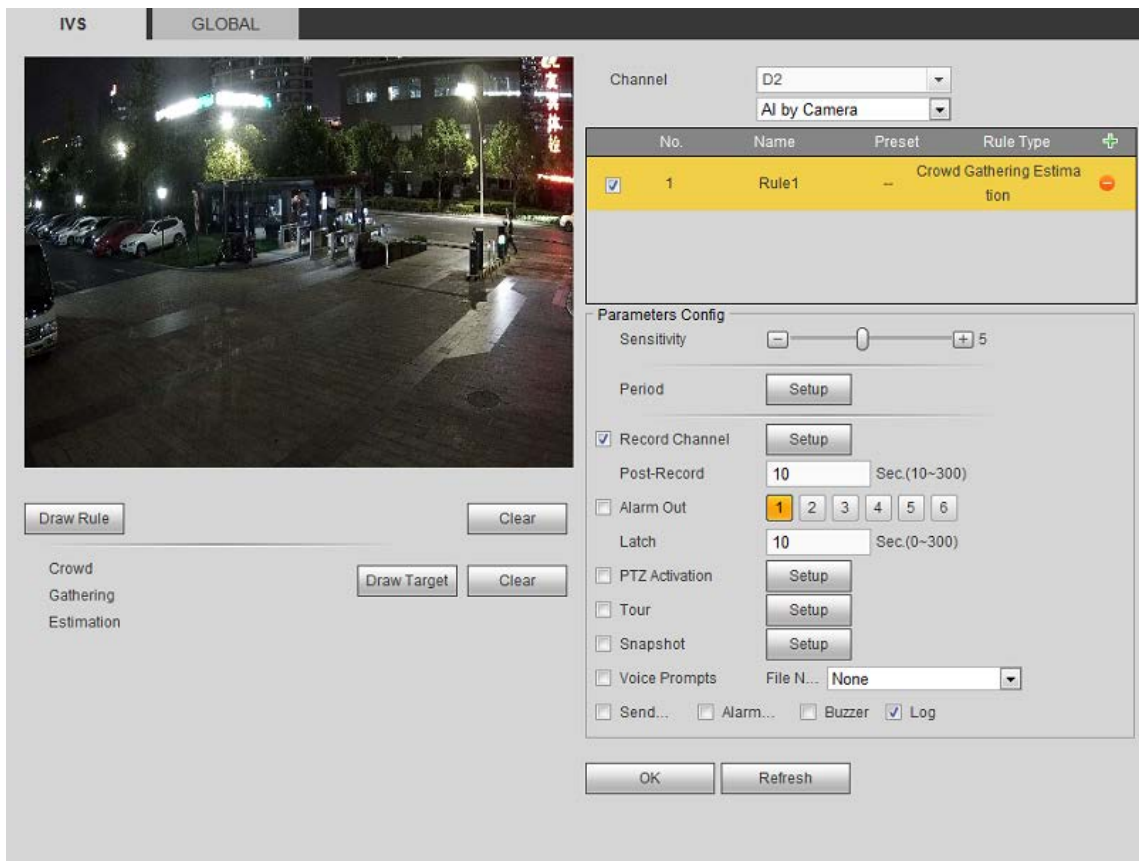

Figure 5-76

Step 3 Configure the parameters. For details, see chapter 5.11.3.3.1 Tripwire and the following table.

Parameter	Description
Duration	Set the minimum time when the target appears in the zone to trigger an alarm.
Sensitivity	Set the sensitivity to trigger the alarm. It can be 1~10, and the default is 5.
Minimum Gathering Area	Click Draw Target to draw the minimum gathering area model in the scene. An alarm is triggered when the number of people in the specified area is greater than the size of the model and exceeds the duration. Click Clear to delete the model you have drawn.

Step 4 Click OK to complete the setting.

### 5.11.3.3.7 Missing Object

When the detection target is moved out of the monitoring area for more than the set duration, the system performs an alarm linkage action.

Step 1 Select AI by Camera.

Step 2 In the Rule Type drop-down list, select Missing. See Figure 5-77.



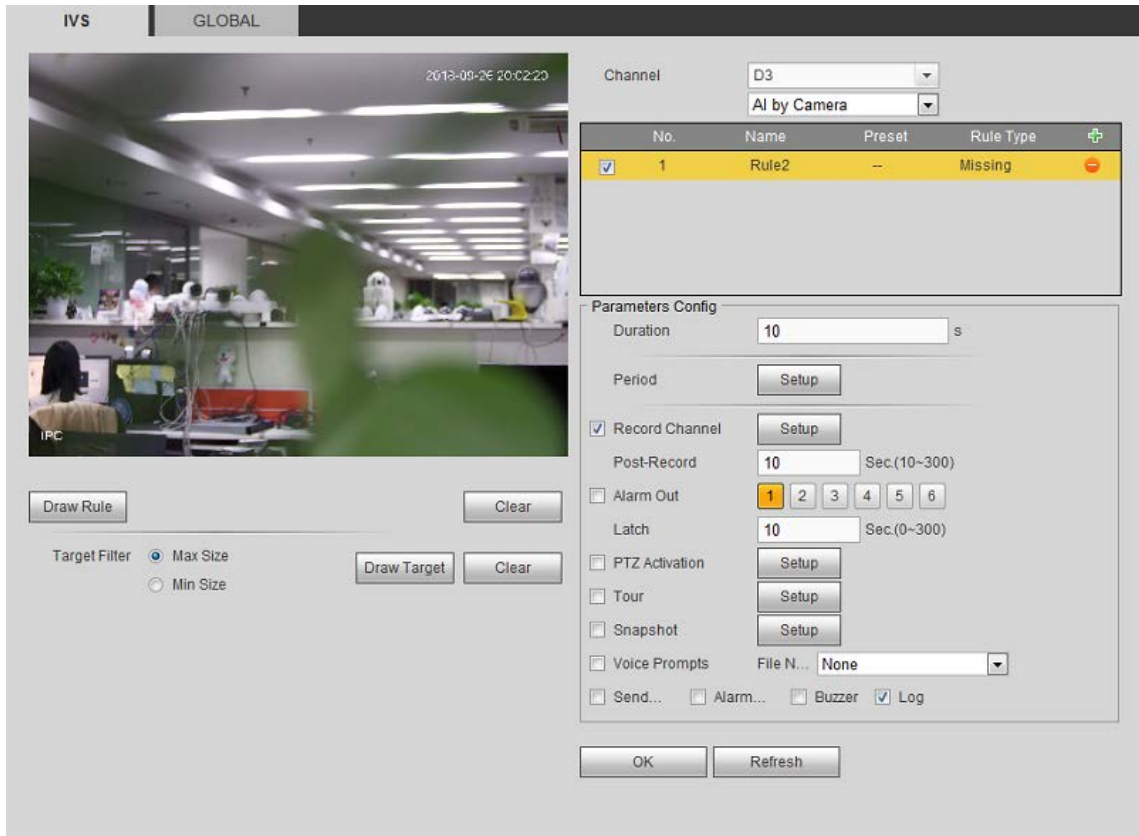

Figure 5-77

Step 3 Configure the parameters. For details, see chapter 5.11.3.3.1 Tripwire and the following table.

Parameter	Description
Duration	Configure the shortest time from the disappearance of the object and the triggering of the alarm.

Step 4 Click OK to complete the setting.

### 5.11.3.3.8 Loitering Detection

When the detection target is in the monitoring area for more than the set duration, the system performs an alarm linkage action.

Step 1 Select AI by Camera.

In the Rule Type drop-down list, select Loitering Detection. See Figure 5-78.

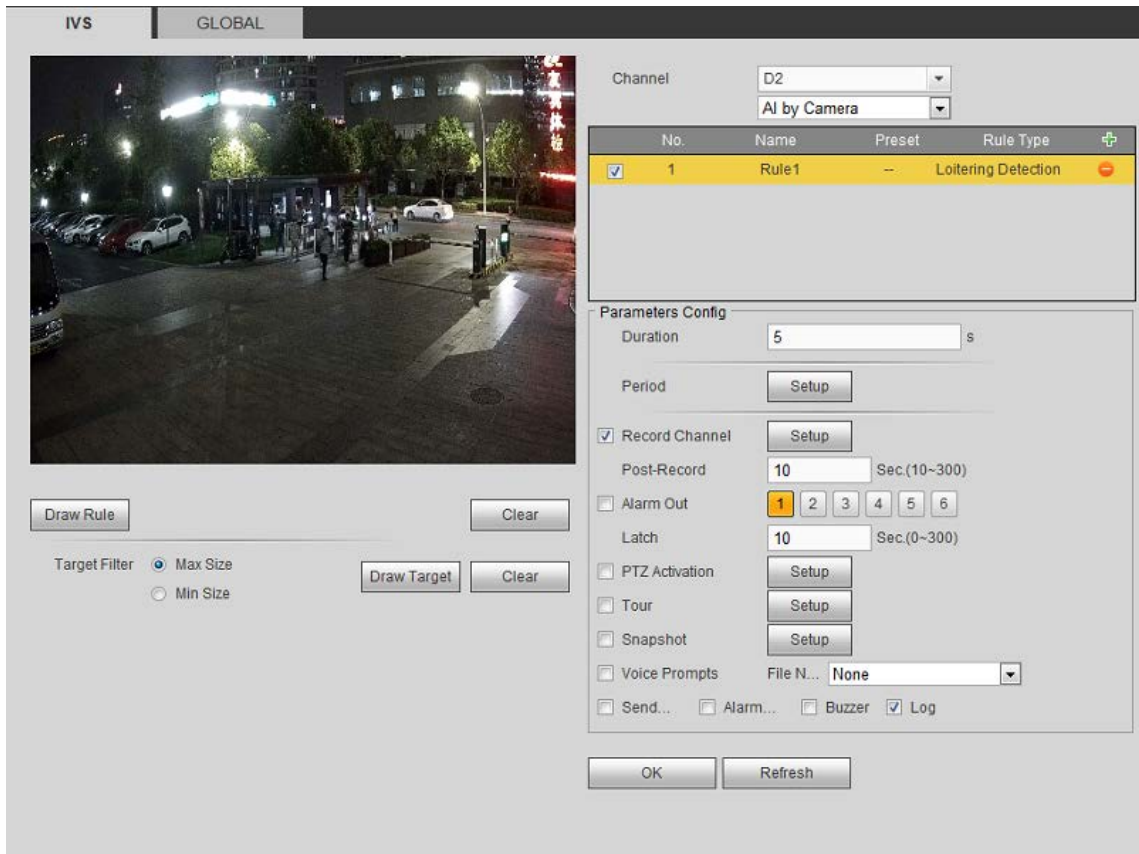

Figure 5-78

Step 2 Configure the parameters. For details, see chapter 5.11.3.3.1 Tripwire and the following table.

Parameter	Description
Duration	Set the minimum time when the target appears in the zone to trigger an alarm

Step 3 Click OK to complete the setting.

### 5.11.3.3.9 Global Config

According to the calibration of one horizontal scale, three vertical scales and the actual distance corresponding to each scale, the NVR device can estimate the internal parameters of the IPC (including internal geometric and optical characteristics) and external parameters of the IPC (position and direction relative to the actual environmental coordinate system) to determine the actual distance of the shooting scene.

Step 1 Select Setup > Event > IVS > Global.

The Global interface is displayed. See Figure 5-79.

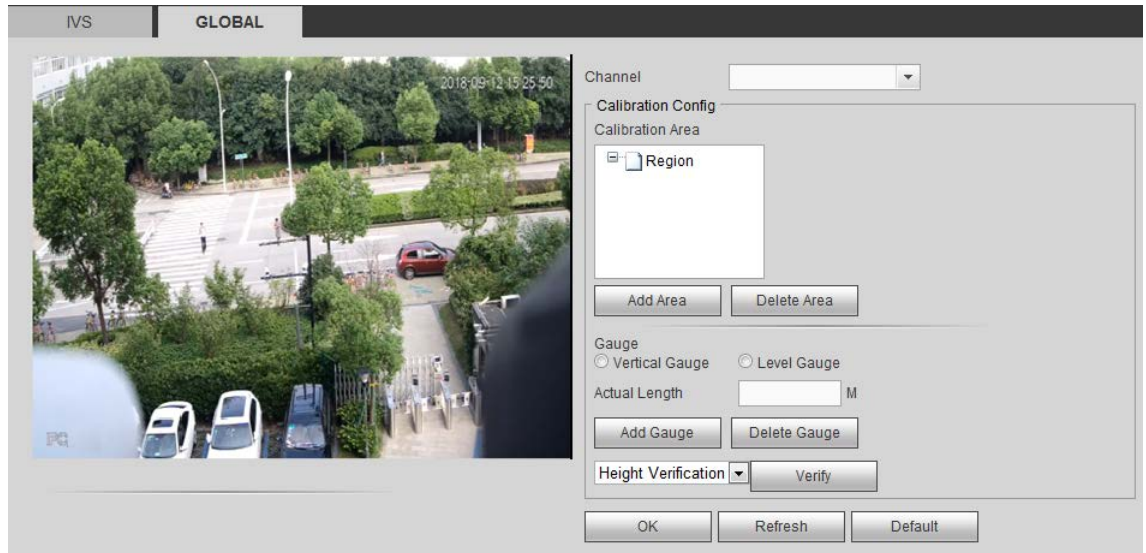

Figure 5-79

Step 2 Select the channel number.

Step 3 Set the calibration area.

- 1) Click Add Area and then you can draw the calibration area in the preview screen on the left. Select the calibration area and click Delete Area to delete the corresponding area.
- 2) Select the gauge type (horizontal or vertical) and set the corresponding actual length. You can draw at most three vertical gauges and one horizontal gauge in the preview screen on the left.
- 3) Select Height Verification or Width Verification and click Verify. Draw any line in the calibration area and it will display its corresponding actual length.

Step 4 Click OK to activate the settings.

### 5.11.3.4 Face Detection

By the processing and analysis of videos from the camera, the system activates an alarm action when face information is detected.



NOTE

Face detection and smart analysis are mutually exclusive.

Step1 Select Setup > Event > Face Detection.

The Face Detection interface is displayed. See Figure 5-80.

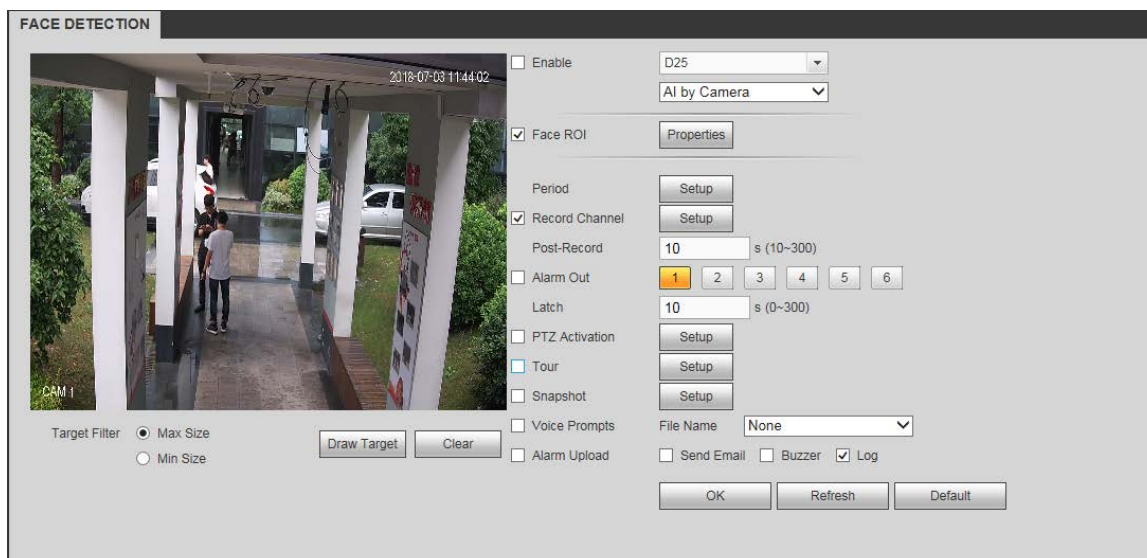







Figure 5-80

Step2 Configure the parameters. For details, see the following table.

Parameter	Description
Enable	Select the check box to enable face detection. Select the channel and AI mode (including AI by Camera and AI by Device). <ul style="list-style-type: none"> <li>AI by Camera: Enable the AI function of the front-end camera. The camera shall support face detection.</li> <li>AI by Device: Enable the AI function in NVR device and you can use any camera to do face detection.</li> </ul>
Period	Here you can set face detection period. System only enables face detection in the specified periods.
Face ROI	NOTE This function is supported when AI by Camera is enabled.
Attribute	Set the items to compare, such as age, gender and glasses.
Record Channel	Select the check box and select the channel (supporting multi-check). When an alarm occurs, the NVR device activates the corresponding channel to take records.  NOTE You shall enable smart record and auto record functions first.
Post-Record	System can delay the record for specified time after alarm ended. The value ranges from 10s to 300s.
Alarm Out	When an alarm occurs, system enables peripheral alarm devices.
Latch	The system auto delays the alarm action for a specified period after the ending of the alarm. The value ranges from 0-300(Unit: second)
PTZ Activation	Select the check box and click Setting to set the channel and actions. When an alarm occurs, the NVR device activates the corresponding channel to perform the PTZ action. For example, turning the PTZ to preset point X.  NOTE You shall set the corresponding PTZ action first. For details, see "5.7 PTZ."

Parameter	Description
Tour	Select the check box and select the tour channels. When an alarm occurs, the NVR local interface displays the tour image of the selected channel  NOTE You shall set the tour interval and tour mode first. After the tour ends, the preview screen returns to the split mode before the tour.
Snapshot	Select the check box and select the channel for snapshot. When an alarm occurs, the NVR device triggers snapshot for the select channel.  NOTE You shall enable smart record and auto record functions first.
Voice Prompts	Select the check box and select the voice file in the File Name drop-down list. When an alarm occurs, the system plays the corresponding voice file.  NOTE You shall add the voice file first.
Alarm Upload	Select the check box and the system uploads alarm signal to the network (including alarm center) when an alarm occurs.  NOTE <ul style="list-style-type: none"> <li>● Only some models support this function. See the actual situation.</li> <li>● You shall set the alarm center first.</li> </ul>
Send Email	System can send out email to alert you when an alarm occurs  NOTE You shall set the Email first.
Buzzer	Select the check box and the NVR device triggers the buzzer when an alarm occurs.
Log	Select the check box and the NVR device records the alarm information in the log.

Step3 Click OK to complete the configuration.

## 5.11.3.5 Face Recognition

The system supports to compare the detected faces with the configured faces in the face library.

### 5.11.3.5.1 Face Library Management

Only after the face library configuration, you can compare the detected face with the information in the face library. It includes creating face library, adding face images and face modeling.

 NOTE

To protect personal privacy, the faces in the picture have been blurred.

## Creating Face Library

Step1 Select Setup > Event > Face Recognition > Face Library.

The Face Library interface is displayed. See Figure 5-81.

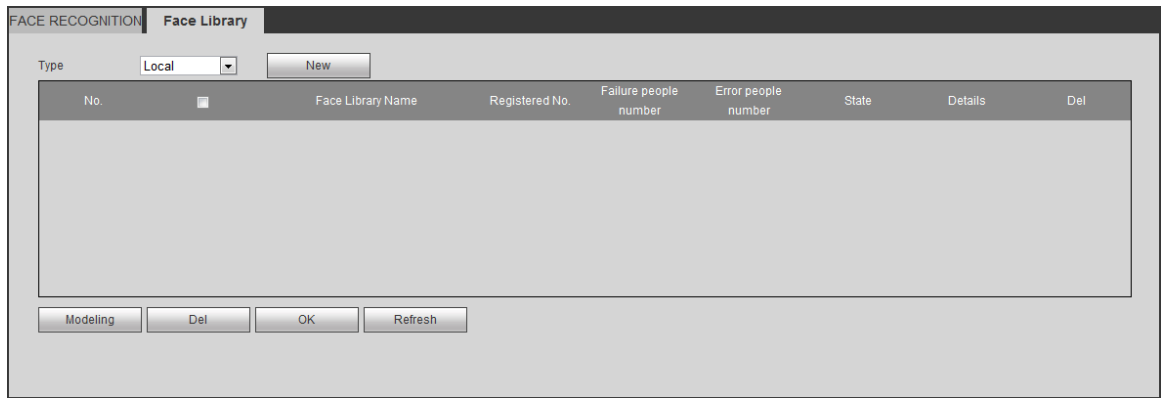

Figure 5-81

Step2 Select the type in the Type drop-down list, including local and remote.

 NOTE

Local means that the face information is save in the NVR device. Remote means that the face information is saved in the IPC.

Step3 Click New.

The Add interface is displayed. See Figure 5-82.

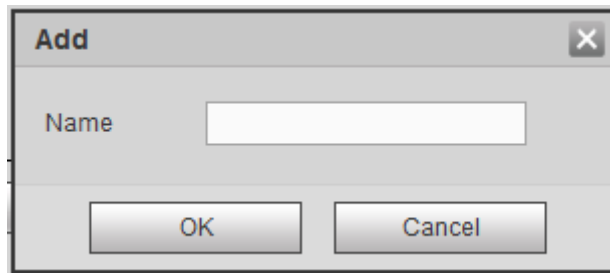

Figure 5-82

Step4 Enter face library name and click OK.

System saves the face library successfully. See Figure 5-83.

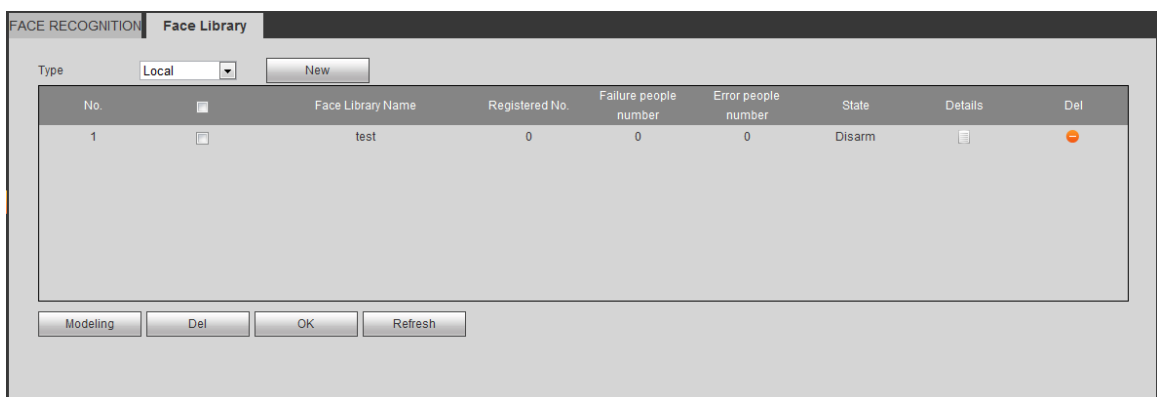



Figure 5-83

## Registering Face Image

It is to register face images to the face library. It supports two ways: single register and batch register.

 NOTE

When you import images from the U flash disk, the image shall be smaller than 256K and the resolution shall be 200×200-6000×5000.

Step 1 In Figure 5-83, click  corresponding to the face library.  
The Details interface is displayed. See Figure 5-84.

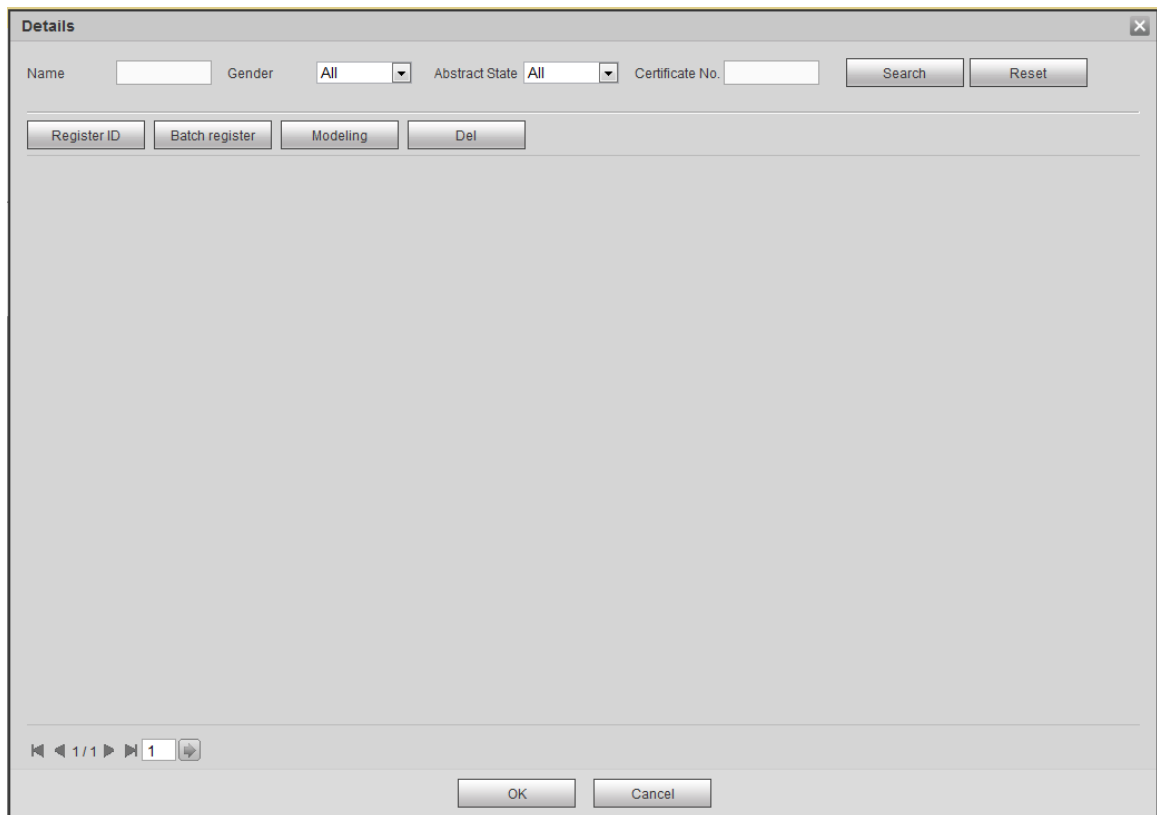

Figure 5-84

Step 2 Register face image. The system supports single register and batch register.

- Single Register
  1. Click Register ID.

The Register ID interface is displayed. See Figure 5-85.

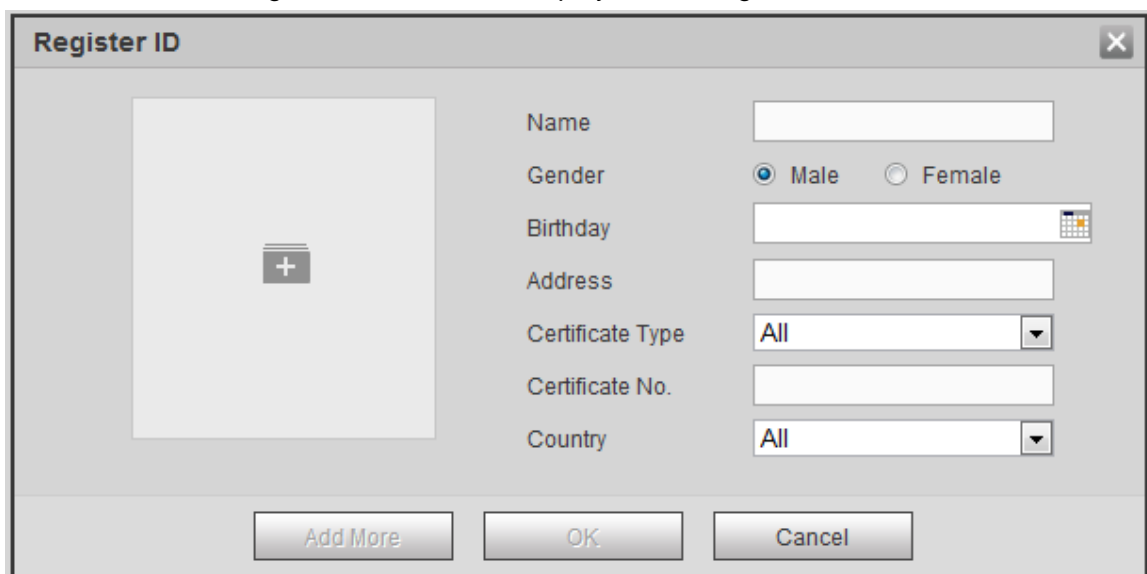

Figure 5-85

2. Click  to add picture.

The File List interface is displayed. See Figure 5-86.

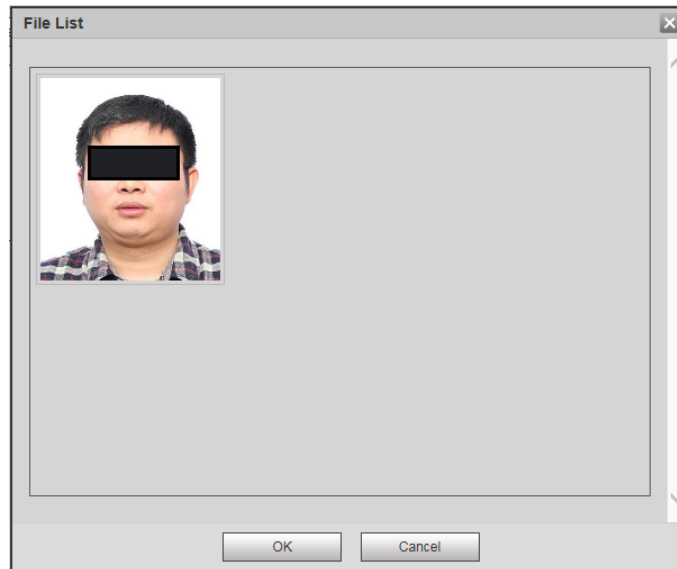

Figure 5-86

3. Select the image and click OK.
4. Enter the personnel information.
5. Click OK to complete the register. The system displays as Figure 5-87

 NOTE

Click Add More to register multiple images.

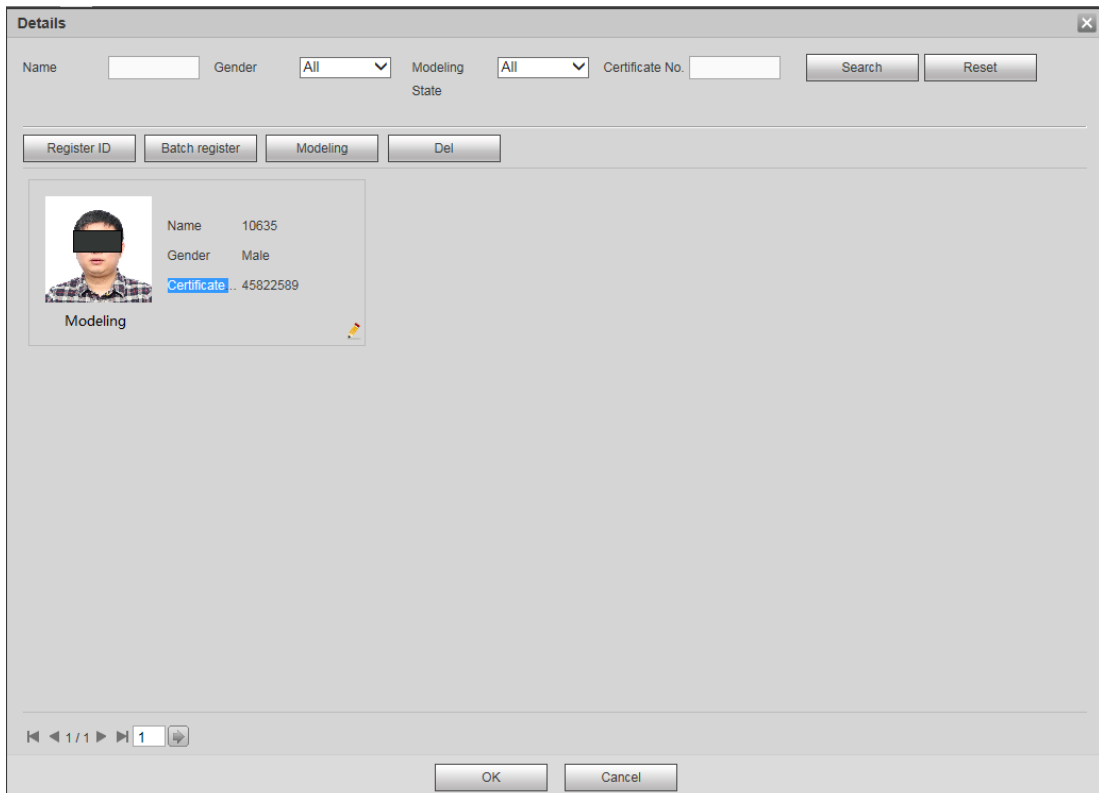

Figure 5-87

- Batch Register



1. Name the picture in accordance with the rule: Name#SGender#BBirthDay#NCountry#P Province#TID type#MID No.#AAddress.jpg. For example, Tom#S1#B1990-01-01#NUS# T2#M123456789 #ANorth Main Street.jpg.



NOTE

Name is required and others are optional.

2. In Figure 5-84, click Batch Register.  
The Browse interface is displayed. See Figure 5-88.

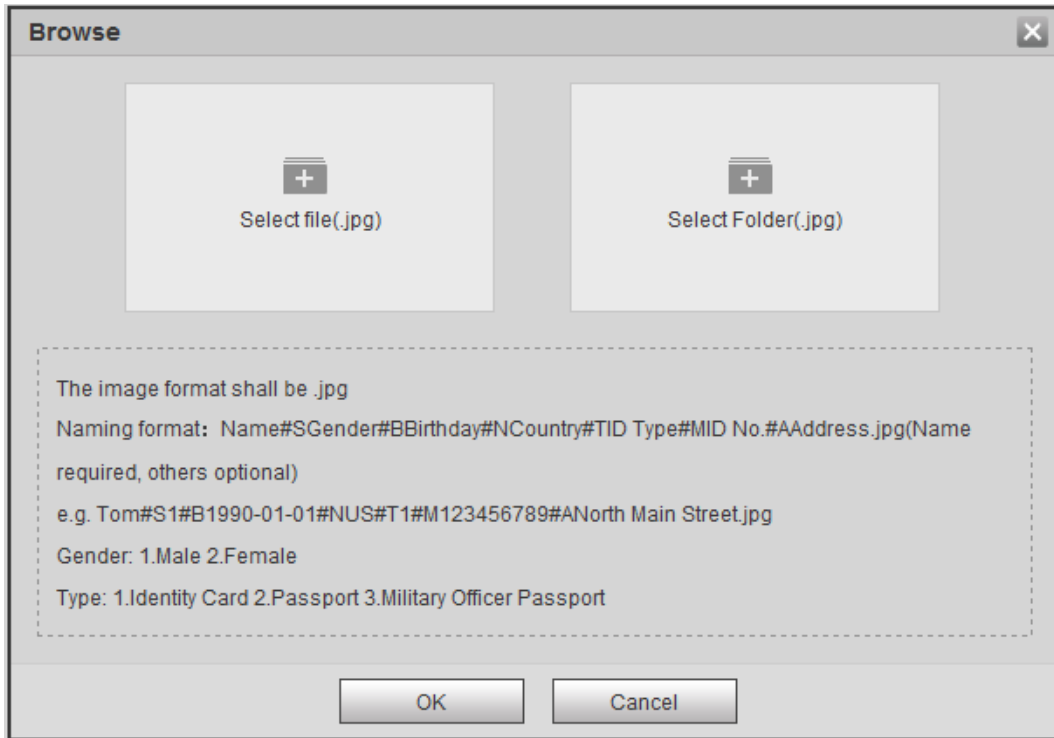



Figure 5-88

3. Click  to import image or click  to import folder.
4. Click OK and system displays the Progress interface. See Figure 5-89.

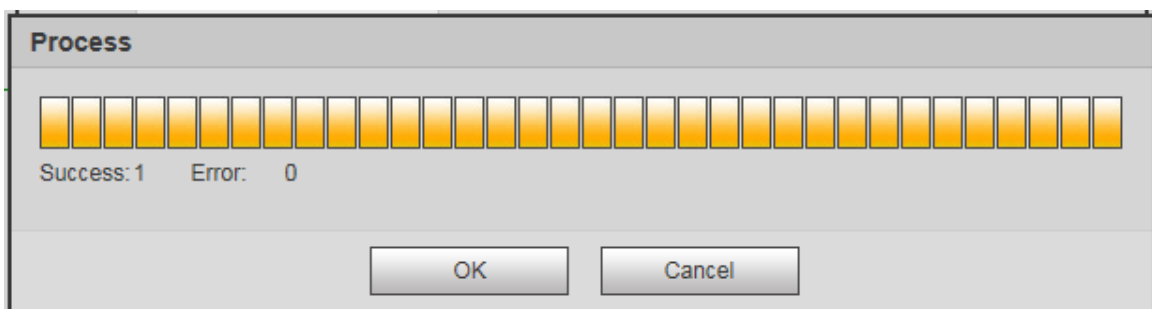

Figure 5-89

5. Click OK and the system displays Modeling. See Figure 5-90.

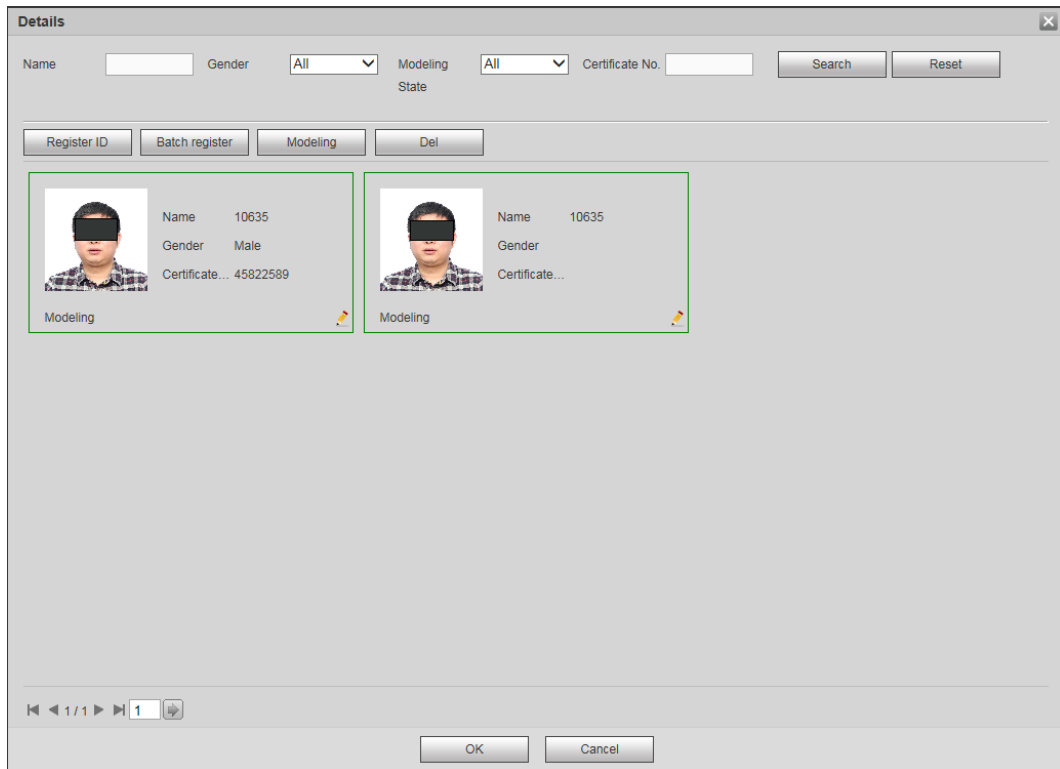

Figure 5-90

Step 3 Click Search to refresh the interface.

The system displays successful modeling. See Figure 5-91.

 **NOTE**

In modeling means that the system is extracting the properties of the image. If the modeling is failed, this image cannot work for face recognition.

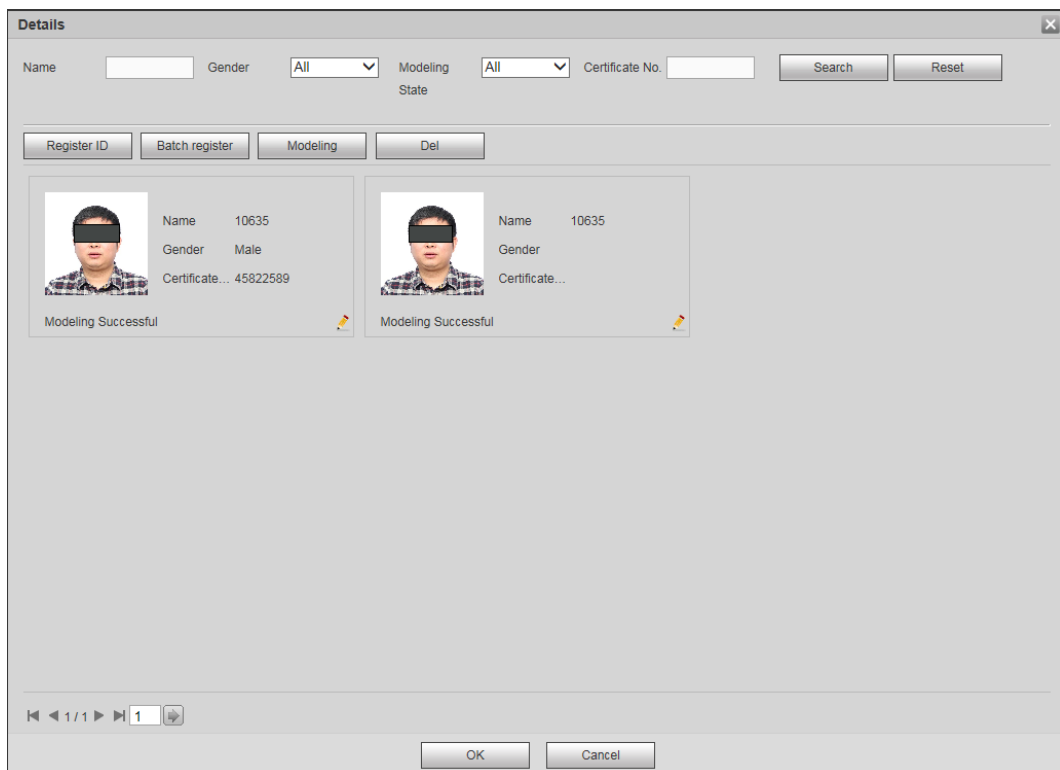

Figure 5-91

### 5.11.3.5.2 Face Recognition Configuration

Through the analysis of the video images captured by the camera, the system compares the detected face images with the images in the face library and performs alarm linkage actions.

Step 1 Select Setup > Event > Face Recognition > Face Recognition.

The Face Recognition interface is displayed. See Figure 5-92.

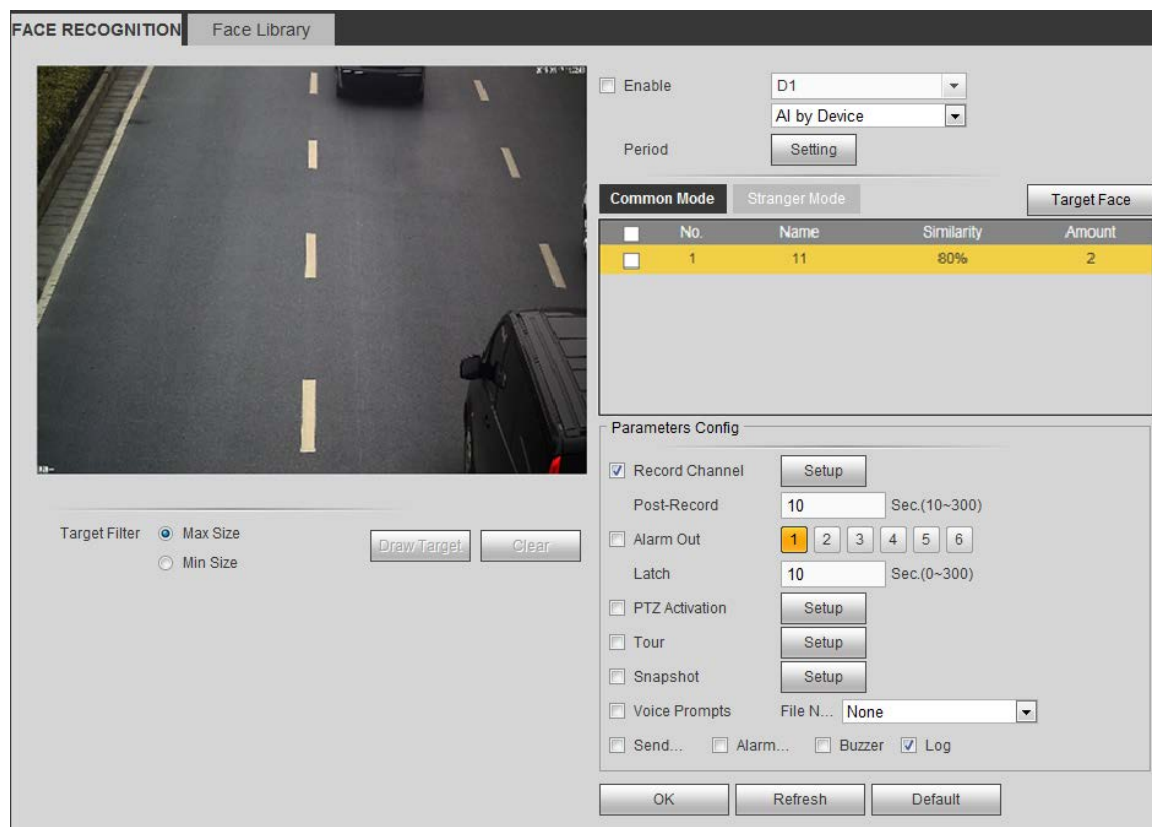









Figure 5-92

Step 2 Set the parameters. For details, see the below table.

Parameter	Note
Channel	Select the channel and AI mode, including AI by camera and AI by device. AI by camera: Enable the AI function of the camera. The front-end camera shall support face detection. AI by device: Enable the AI function of the NVR device. You can use any regular camera to do face detection.
Face ROI	Select the check box to enable it. NOTE Only AI by camera supports this function.
Properties	Set the items for face recognition, such as age, gender and glasses.
Period	Set the time for deployment and removal. The corresponding alarm will start only in the set time period.
Common Mode	Click this tab to display the common mode interface.
Stranger Mode	Click this tab and then click the Enable check box to enable the stranger mode.

Parameter	Note
Target Face	Click it to display the face library list and select the library you need for face recognition.
Draw Target	Click Draw Target to draw the size of the target filter model. Click the clear icon on the right side to delete the model. Two filters (min size and max size) can be set for each rule. Targets larger than the max size and targets smaller than the min size will not cause alarms. The max size shall be no smaller than the min size.  NOTE Only AI by camera supports this function.
Clear	Click Clear to delete the target filter model.
Face library list	Select the face library from the list. For face library configuration, see chapter 5.11.3.5.1 Face Library Management. "
Record channel	Select the check box and the video channel (multi-choice acceptable) . when an alarm occurs, NVR enables the channel to start video recording.  NOTE Smart Record and Auto Record shall be already enabled. For details, see chapter 4.1.4.5 Schedule.
Post-record	The video extends for 10~300 seconds after the ending of the alarm.
Alarm output	Connect alarm device (light, siren, etc.) at the alarm output port and the NVR device sends the alarm information to the alarm device when an alarm occurs.
Latch	The alarm extends for 0~300 seconds after the ending of alarm information.
PTZ Linkage	Select the check box. Click Setting and select the linkage PTZ channel and action. The NVR device links the channel to perform the corresponding PTZ action. E.g. PTZ of Channel one turns to preset point X.  NOTE The corresponding PTZ action shall be already set.
Tour	Select the check box and choose the channel for touring. The NVR local interface will work in tour and display the images of the selected channel.  NOTE The tour interval and mode shall be already set. When the alarm linked tour ends, the preview interface returns to the image segmentation model.
Snapshot	Select the check box and choose the channel for snapshot. NVR triggers snapshot for the selected channel when the alarm occurs.  NOTE Smart snapshot and auto snapshot shall be already enabled.
Voice prompt	Select the check box. Select the corresponding voice file in the File Name. The system plays this voice file when the alarm occurs.  NOTE The corresponding voice file shall be already added. For details, see chapter 4.10.3 Voice.

Parameter	Note
Alarm upload	Select the check box and NVR device uploads alarm signals to the network (including alarm center) when an alarm occurs.  NOTE Only some devices support this function. Please refer to the actual. The alarm center shall be set. For detailed operations, see chapter 5.11.2.10 Alarm Centre.
Sending email	Select the check box. NVR device sends an email to the appointed email box when an alarm occurs.  NOTE Email shall be set first. For details, see chapter 4.8.1.6 Email.
Buzzer	Select the check box. NVR device calls the buzzer when the alarm occurs.
Log	Select the check box. NVR records the alarm information in the log when the alarm occurs.

Step 3 Click OK to complete the configuration.

### 5.11.3.6 Video Structurization

Video structurization includes personnel detection, face detection, vehicle detection and non-motor vehicle detection. After enabling the intelligent plan, the corresponding function can come into effect.

 NOTE

Video structurization includes AI by camera and AI by device.

- AI by camera: It means that the specific IPC itself supports intelligent analysis, and the NVR only needs to support the detection and display of intelligent alarm information from the IPC, and supports intelligent analysis configuration and video playback of the IPC.
- AI by camera: It means that the front-end IPC does not perform intelligent analysis, and it is intelligently analyzed by the NVR.

Step 1 Select Setup > Event > Video Structurization.

The Video Structurization interface is displayed. See Figure 5-93.

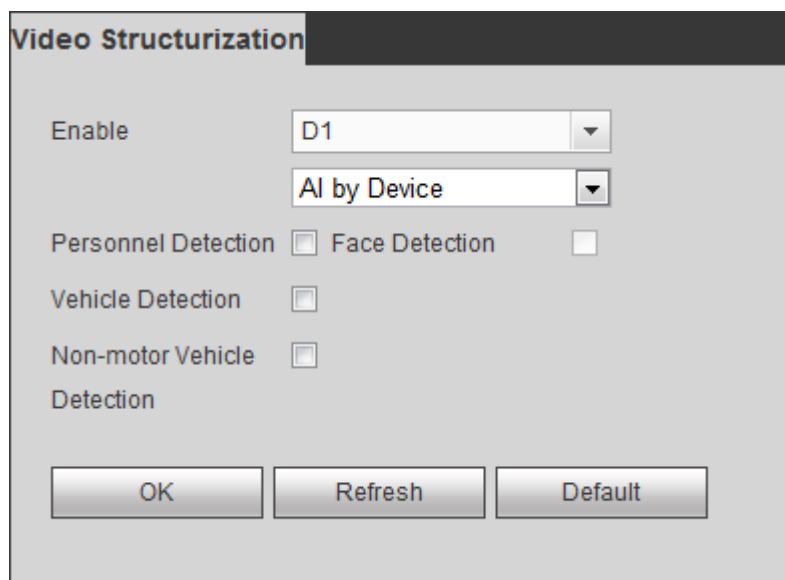

Figure 5-93

Step 2 Select the channel number and configure the parameters. For details, see the following table.

Parameter	Description
AI Type	Select the AI type. The system supports AI by camera and AI by device. NOTE When you select AI by camra, you shall connect intelligent IPC on the front end.
Personnel Detection	Select Personnel Detection. When the human body information is detected, the system performs an alarm linkage action.
Face Detection	Select Face Detection. When the face information is detected, the system performs an alarm linkage action. NOTE To enable face detection, you need to enable the personnel detection function first.
Vehicle Detection	Select Vehicle Detection. When the vehicle information is detected, the system performs an alarm linkage action.
Non-motor Vehicle Detection	Select Non-motor Vehicle Detection. When the non-motor vehicle information is detected, the system performs an alarm linkage action.

Step 3 Click Apply or OK to complete the configuration.

### 5.11.3.7 ANPR

ANPR adopts the video image recognition technology to extract the license plate number in the video image and match the preset license plate number. After the matching is successful, the system performs the alarm linkage action.

### 5.11.3.7.1 ANPR Configuration

You can set ANPR rules and alarm linkage actions in different situations (blocklist, allowlist, and normal).

Step 1 Select Setup > Event > ANPR.

The ANPR interface is displayed. See Figure 5-94

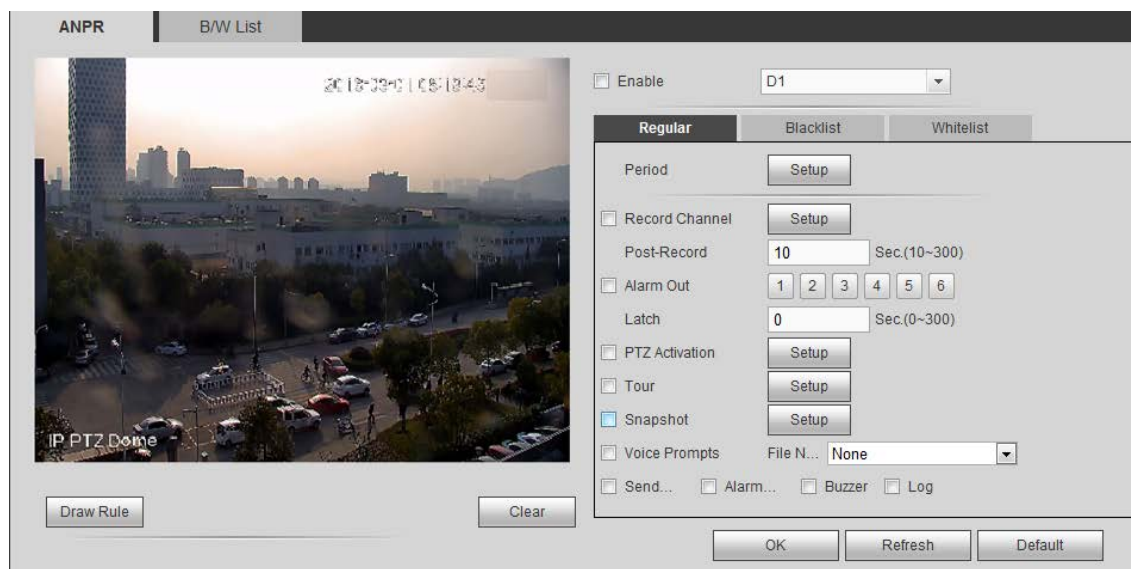

Figure 5-94

Step 2 Select the Enable check box and select the channel number.

Step 3 Set the ANPR rule name and click Draw Rule to draw the rule area in the monitoring screen. Click Clear to clear the drawn rule area.

Step 4 Click Regular tab, Blacklist tab or Allowlist tab according to the actual situation. The system displays the Regular interface by default.







 NOTE

Before triggering blacklist/allowlist alarm linkage action, you shall add the license numbers to the black/allowlist.

- Regular: Configure alarm parameters on this interface and the system links alarms when all license plates are detected.
- Blacklist: Configure alarm parameters on this interface and the system only links alarms when the license plate in the blacklist is detected.
- Allowlist: Configure alarm parameters on this interface and the system only links alarms when the license plate in the allowlist is detected.

Step 5 Configure the parameters. For details, see the following table.

Parameter	Description
Period	Configure the period and in the set time range, the corresponding configuration item will be linked to start the alarm.
Alarm Out	The alarm device (such as lights, sirens, etc.) is connected to the alarm output port. When an alarm occurs, the NVR device transmits the alarm information to the alarm device.
Latch	When the alarm ends, the alarm extendeds for a period of time. The time range is from 0 seconds to 300 seconds.

Parameter	Description
Alarm Upload	<p>Select the check box. When an alarm occurs, the NVR device uploads an alarm signal to the network (including the alarm center).</p> <p> NOTE</p> <ul style="list-style-type: none"> <li>• Only some devices support this function. See the actual situation.</li> <li>• You shall set the alarm center first.</li> </ul>
Send Email	<p>Select the check box. When an alarm occurs, the NVR device sends an email to the set mailbox to notify the user.</p> <p> NOTE</p> <p>You shall set the email first.</p>
Record Channel	<p>Select the check box and select the needed recording channel (support multiple choices). When an alarm occurs, the NVR device activates the channel for recording.</p> <p> NOTE</p> <p>You shall enable intelligent recording and auto recording first.</p>
PTZ Activation	<p>Select the check box and click Setting to select the channel and PTZ action. When an alarm occurs, the NVR device associates the channel to perform the corresponding PTZ action. For example, activate the PTZ in channel one to turn to the preset point X.</p> <p> NOTE</p> <ul style="list-style-type: none"> <li>• Tripwire alarm supports to activate PTZ preset point only.</li> <li>• You shall set the corresponding PTZ actions first.</li> </ul>
Delay	<p>At the end of the alarm, the recording extends for a period of time. The time range is from 10 seconds to 300 seconds.</p>
Tour	<p>Select the check box and select the channel for tour. When an alarm occurs, the local interface of the NVR device displays the selected channel screen.</p> <p> NOTE</p> <ul style="list-style-type: none"> <li>• You shall set the time interval and mode for tour first.</li> <li>• After the tour is over, the preview interface is restored to the screen split mode before the tour.</li> </ul>
Snapshot	<p>Select the check box and select the channel for snapshot. When an alarm occurs, the NVR device triggers the snapshot of the selected channel.</p> <p> NOTE</p> <p>You shall enable the intelligent snapshot and auto snapshot first.</p>
Log	<p>Select the check box, the NVR device records the alarm information in the log when an alarm occurs.</p>
Voice Prompts	<p>Select the check box and select the corresponding voice file in the File Name drop-down box. When an alarm occurs, the system plays the voice file.</p> <p> NOTE</p> <p>You shall add the corresponding voice file first.</p>
Buzzer	<p>Select the check box to activate the buzzer when an alarm occurs.</p>

Step 6 Click OK or Apply to save the configuration.



### 5.11.3.7.2 Blocklist/Allowlist

To enhance vehicle management, you can add the license plate number to the blocklist or allowlist separately. The system will match the detected license plate information with the license plate information in the block and allowlist, and perform the corresponding alarm linkage action.

After setting the block and allowlist, in the license plate snapshot list on the preview interface, the license plate number in the blocklist is red, the license plate number in the allowlist is green, and the license plate number not in the blocklist and allowlist is marked as white.

#### Adding B/W List

Step 1 Select Setup > Event > ANPR > B/W List.

The B/W List interface is displayed. See Figure 5-95

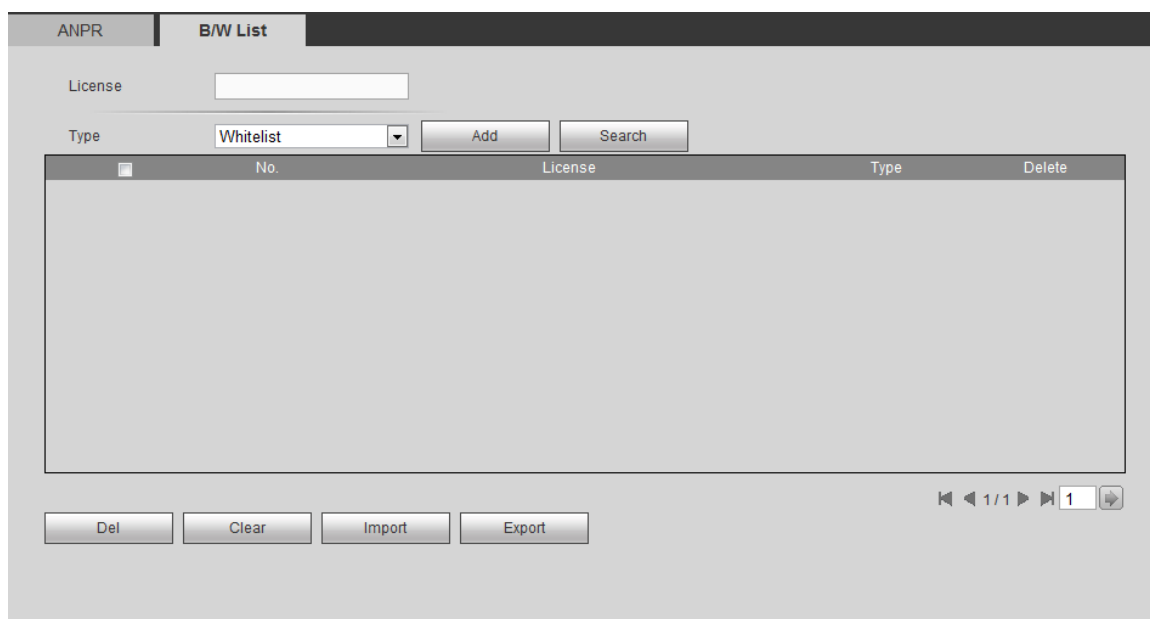



Figure 5-95

Step 2 Enter the license plate information and then select allowlist or blocklist.

Step 3 Click Add to complete the adding of B/W list.

#### Deleting B/W List

In the Type drop-down list, select Blocklist or Allowlist and then click Search. The results are displayed. See Figure 5-96

- In the result list, select the check box in front of the license number or click  corresponding to the license number, you can delete the license info in the B/W list.
- Click Clear to clear all the license info in the B/W list.

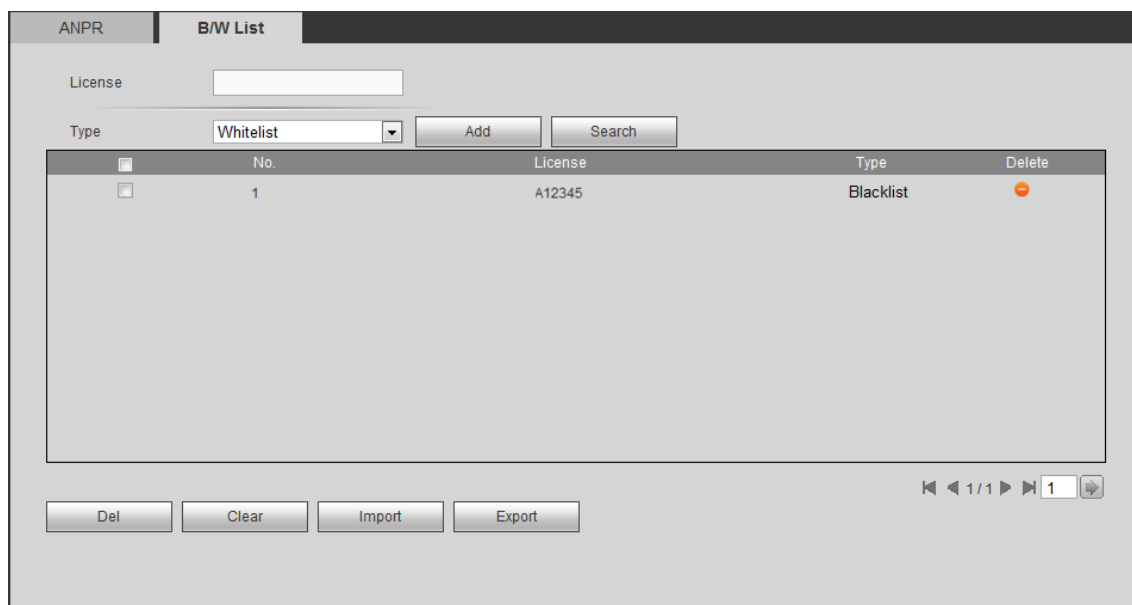

Figure 5-96

### Importing and Exporting B/W List

The system supports importing B/L lists in USB devices and exporting B/W lists to USB devices. The system supports importing .csv files and .xlsx files, and exporting files to .csv format.

- Import B/W list: Click Import, select the file to be imported, and then click Open to import the file.
- Export B/W list: Click Export, select the storage path of the file, and then click Save.

### 5.11.3.8 People Counting

People counting uses video image analysis technology to effectively count the number of people in the video and the flow direction of the crowd. When the number of people entering and leaving the monitoring area exceeds the set person value, the system performs alarm linkage action.

Step 1 Select Setup > Event > People Counting.

The People Counting interface is displayed. See Figure 5-97

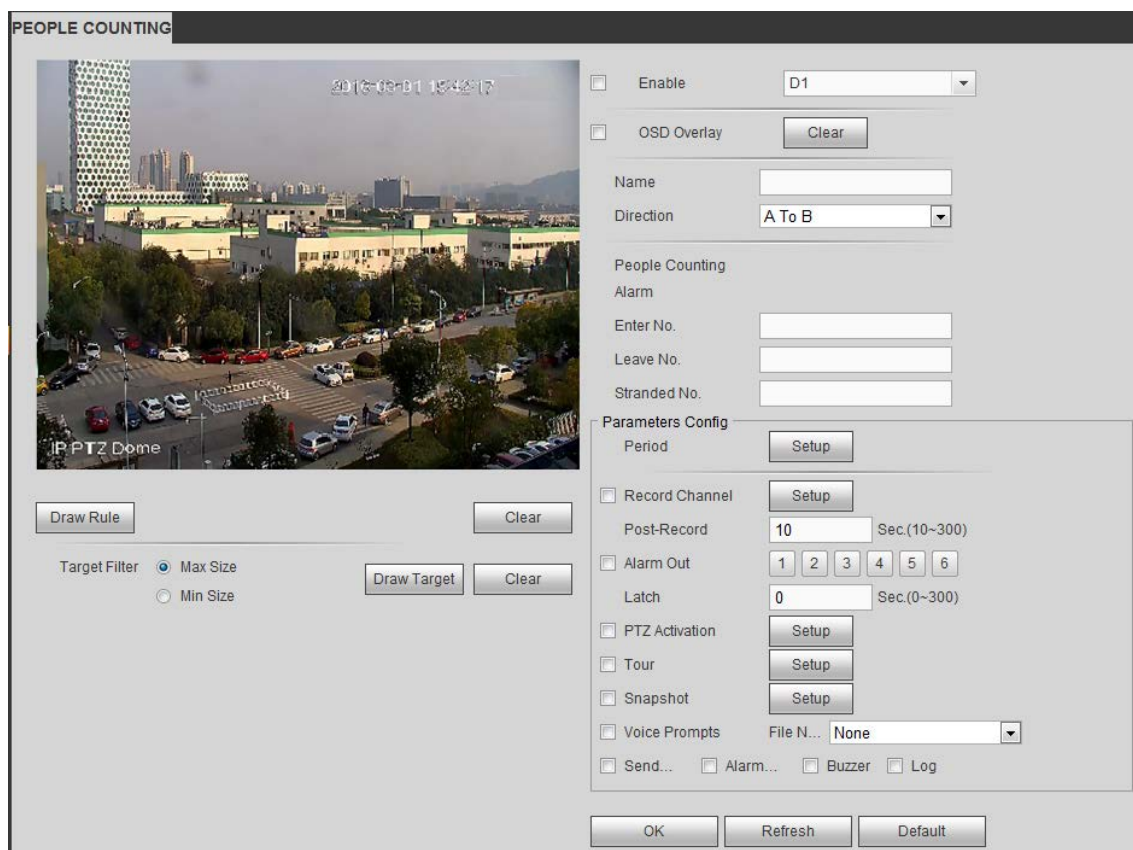









Figure 5-97

Step 2 Configure the parameters. For details, see the following table.

Parameter	Description
Channel	Select the Enable check box and select the channel to set people counting.
OSD Overlay	Select the check box and the system displays people number in real time on the screen.
Name	Enter the rule name of people counting.
Direction	Set the direction of people flow, including A To B and B To A.
Enter No.	Enter the number of people entering the area. When it exceeds the set value, the system generates an alarm.
Leave No.	Enter the number of people leaving the area. When it exceeds the set value, the system generates an alarm.
Standed No.	Enter the number of people stayed in the area. When it exceeds the set value, the system generates an alarm.
Period	Configure the period and in the set time range, the corresponding configuration item will be linked to start the alarm.
Alarm Out	The alarm device (such as lights, sirens, etc.) is connected to the alarm output port. When an alarm occurs, the NVR device transmits the alarm information to the alarm device.
Latch	When the alarm ends, the alarm extendeds for a period of time. The time range is from 0 seconds to 300 seconds.

Parameter	Description
Alarm Upload	<p>Select the check box. When an alarm occurs, the NVR device uploads an alarm signal to the network (including the alarm center).</p> <p> NOTE</p> <ul style="list-style-type: none"> <li>• Only some devices support this function. See the actual situation.</li> <li>• You shall set the alarm center first.</li> </ul>
Send Email	<p>Select the check box. When an alarm occurs, the NVR device sends an email to the set mailbox to notify the user.</p> <p> NOTE</p> <p>You shall set the email first.</p>
Record Channel	<p>Select the check box and select the needed recording channel (support multiple choices). When an alarm occurs, the NVR device activates the channel for recording.</p> <p> NOTE</p> <p>You shall enable intelligent recording and auto recording first.</p>
PTZ Activation	<p>Select the check box and click Setting to select the channel and PTZ action. When an alarm occurs, the NVR device associates the channel to perform the corresponding PTZ action. For example, activate the PTZ in channel one to turn to the preset point X.</p> <p> NOTE</p> <ul style="list-style-type: none"> <li>• Tripwire alarm supports to activate PTZ preset point only.</li> <li>• You shall set the corresponding PTZ actions first.</li> </ul>
Delay	<p>At the end of the alarm, the recording extends for a period of time. The time range is from 10 seconds to 300 seconds.</p>
Tour	<p>Select the check box and select the channel for tour. When an alarm occurs, the local interface of the NVR device displays the selected channel screen.</p> <p> NOTE</p> <ul style="list-style-type: none"> <li>• You shall set the time interval and mode for tour first.</li> <li>• After the tour is over, the preview interface is restored to the screen split mode before the tour.</li> </ul>
Snapshot	<p>Select the check box and select the channel for snapshot. When an alarm occurs, the NVR device triggers the snapshot of the selected channel.</p> <p> NOTE</p> <p>You shall enable the intelligent snapshot and auto snapshot first.</p>
Log	<p>Select the check box, the NVR device records the alarm information in the log when an alarm occurs.</p>
Voice Prompts	<p>Select the check box and select the corresponding voice file in the File Name drop-down box. When an alarm occurs, the system plays the voice file.</p> <p> NOTE</p> <p>You shall add the corresponding voice file first.</p>
Buzzer	<p>Select the check box to activate the buzzer when an alarm occurs.</p>

Step 3 Click OK to complete the configuration.

 NOTE

After the people counting is configured, you can select Info > Event > People Counting to view the statistical report.

### 5.11.3.9 Heat Map

It is to detect the object activity level in the scene during the specified period.

From main menu>Setup>Event>Heat Map, you can see an interface shown as in Figure 5-98.

For detailed setups, please refer to chapter 5.11.3.1.1 motion detect for detailed information.

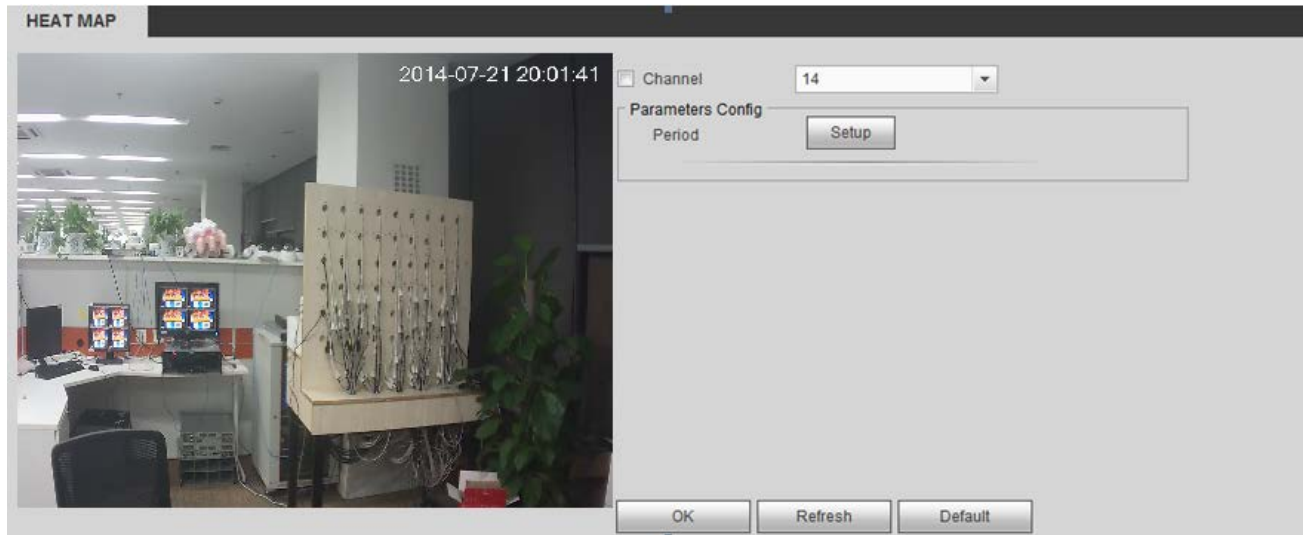

Figure 5-98

### 5.11.3.10 Plate Recognition

License plate recognition adopts video image recognition technology to extract the license plate number in video image and match it with the pre-set license plate number. After successful matching, the system performs alarm linkage action

#### 5.11.3.10.1 Configuring Plate Recognition

You can set the different plate recognition detection rules and alarm linkage actions under different conditions (B/W list and regular)

Step 1 Select Setup > Event > ANPR.

The ANPR interface is displayed. See Figure 5-184.

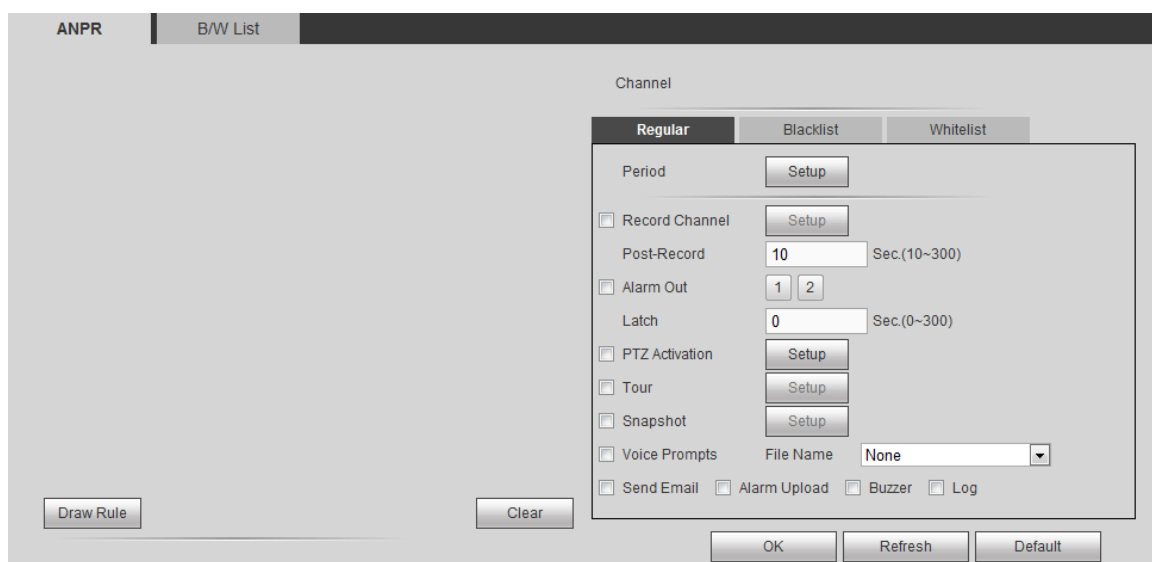

Figure 5-99

Step 2 Select the Enable check box and choose the channel.

Step 3 Enter the Name and click Draw Rule to draw the rule region on the monitor screen.

Click Clear to cancel the drawing.

Step 4 Click the Regular, Allowlist or Blocklist tab according to actual needs. System displays the Regular tab by default.



#### NOTE

You need to configure the B/W list before using the B/W alarm linkage. For details, see 4.7.9.2 B/W List.

- Regular: System activates alarm when any car plate is detected.
- Blocklist: System activates alarm only when plates in the blocklist is detected.
- Allowlist: System activates alarm only when plates in the allowlist is detected.

Step 5 Configure the parameters.

Step 6 Click OK to save the configuration.

#### 5.11.3.10.2 B/W List

It is to set the blocklist and the allowlist. It includes adding, deleting, importing and exporting blocklist and allowlist.

After setting the blocklist and allowlist, in the plate snapshot list on the preview interface, the blocklist plate number is red, the allowlist plate number is green and the regular plate number is white.

#### Adding B/W List

Step 1 Select Setup > Event > ANPR > B/W List.

The B/W list is displayed. See Figure 5-100.

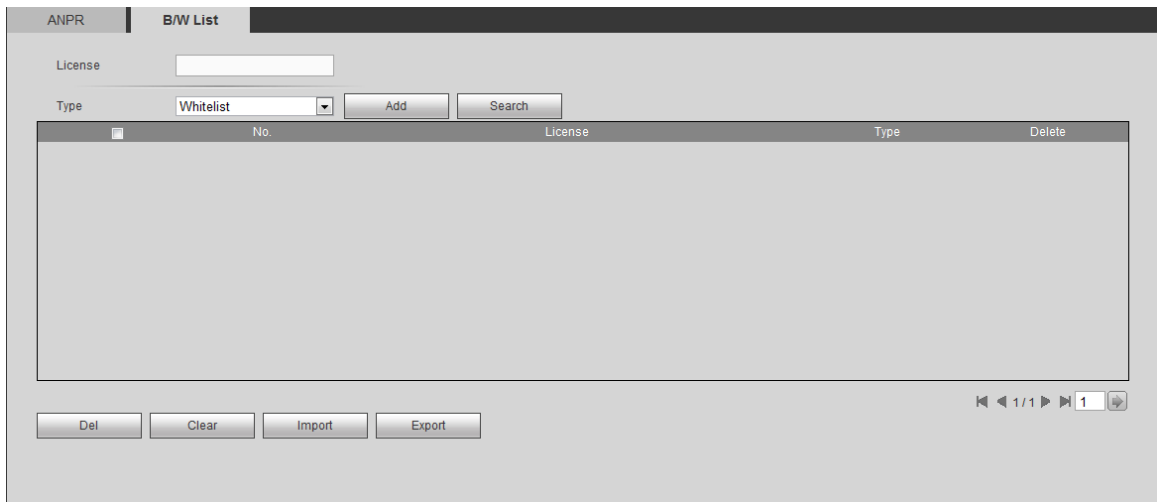



Figure 5-100

Step 2 Enter the plate number and select allowlist or blocklist in the drop-down list.

Step 3 Click Add to complete the registration.

### Deleting B/W List

In the Type list, select allowlist, blocklist or all and click Search, system displays the detailed information. See Figure 5-185.

- Select the check box in front of the plate number and click Delete to delete the plate info in the list.  
You can also click  corresponding to the plate number to delete it.
- Click Clear to delete all the information in the B/W list.

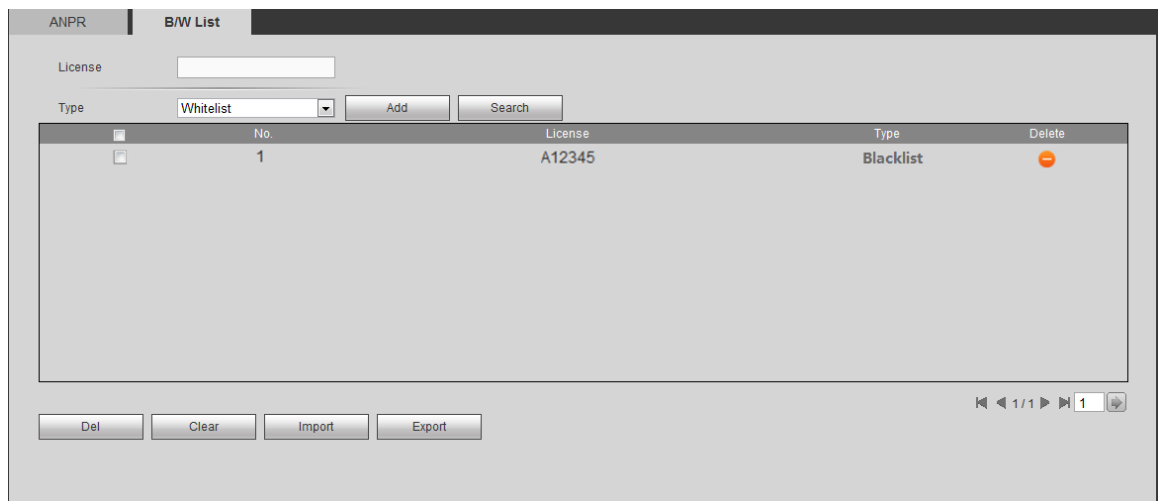

Figure 5-101

### Importing /Exporting B/W List

System supports to import B/W list from the peripheral USB device and export B/W list to the USB device. System supports to import .csv files and .xlsx files, and the exported files are in the format of .csv.

- Importing B/W list: Click Import, select the file, and then click Open to import the file.
- Export B/W list: Click Export, select the save path, and then click Save.

### 5.11.3.11 Audio Detect (Optional)

System can generate an alarm once it detect the audio input is abnormal or audio volume changes.

From main menu>Setup>Event>Audio detect, you can see an interface shown as in Figure 5-102.

- Input abnormal: Check the box here, system can generate an alarm once the audio input is abnormal.
- Intensity change: Check the box here, system can generate an alarm once the audio volume becomes strong.
- Sensitivity: It refers to the audio recognition sensitivity. The higher the value is, the higher the sensitivity is.
- Threshold: It is to set intensity change threshold. The smaller the value is, the higher the sensitivity is.

For detailed setups, please refer to chapter 5.11.3.1.1 motion detect for detailed information.

**AUDIO DETECT**

Channel

Input Abnormal

Intensity Change

Sensitivity  50

Threshold  50

Period

Record Channel

Post-Record  s (10~300)

Alarm Out

Latch  s (0-300)

PTZ Activation

Tour

Snapshot

Voice Prompts File Name

Alarm Upload  Send Email  Buzzer  Log

Figure 5-102

### 5.11.3.12 Alarm

Before operation, please make sure you have properly connected alarm devices such as buzzer. The input mode includes local alarm and network alarm.

#### 5.11.3.12.1 Local Alarm

The local alarm interface is shown as in Figure 5-103. It refers to alarm from the local device.



Local Alarm | Net Alarm | IPC External Alarm | IPC Offline Alarm

Enable    1    Alarm Name

Period   

Anti-Dither    5    Sec.(0-600)    Type    NO   

Record Channel   

Post-Record    10    Sec.(10~300)

Alarm Out    1    2    3    4    5    6

Latch    10    Sec.(0~300)

PTZ Activation   

Tour   

Snapshot   

Voice Prompts    File Name    None   

Show Message     Send Email     Alarm Upload     Buzzer     Log

Figure 5-103

Setup

Thursday    

<input checked="" type="checkbox"/>	00 : 00	-	24 : 00
<input type="checkbox"/>	00 : 00	-	24 : 00
<input type="checkbox"/>	00 : 00	-	24 : 00
<input type="checkbox"/>	00 : 00	-	24 : 00
<input type="checkbox"/>	00 : 00	-	24 : 00
<input type="checkbox"/>	00 : 00	-	24 : 00

Figure 5-104

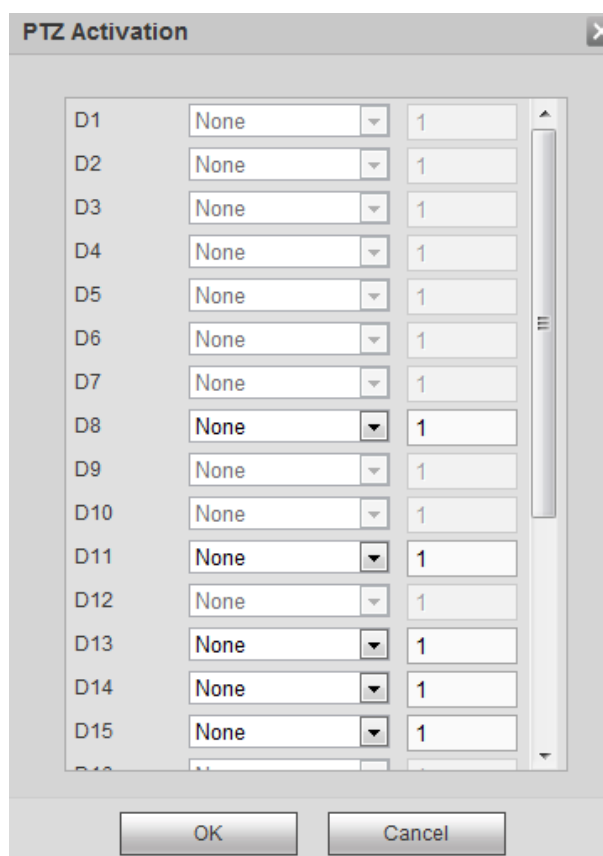

Figure 5-105

Please refer to the following sheet for detailed information.

Parameter	Function
Enable	You need to check the box to enable this function. Please select a channel from the dropdown list.
Period	This function becomes activated in the specified periods. There are six periods in one day. Please draw a circle to enable corresponding period. Select date. If you do not select, current setup applies to today only. You can select all week column to apply to the whole week. Click OK button, system goes back to local alarm interface, please click save button to exit.
Anti-dither	System only memorizes one event during the anti-dither period. The value ranges from 5s to 600s.
Sensor type	There are two options: NO/NC.
Record channel	System auto activates motion detection channel(s) to record once an alarm occurs. Please note you need to set alarm record period and go to Storage> Schedule to set current channel as schedule record.
Record Delay	System can delay the record for specified time after alarm ended. The value ranges from 10s to 300s.
Alarm out	Enable alarm activation function. You need to select alarm output port so that system can activate corresponding

Parameter	Function
	alarm device when an alarm occurs.
Latch	System can delay the alarm output for specified time after an alarm ended. The value ranges from 1s to 300s.
Show message	System can pop up a message to alarm you in the local host screen if you enabled this function.
Buzzer	Check the box here to enable this function. The buzzer beeps when an alarm occurs.
Alarm upload	System can upload the alarm signal to the center (Including alarm center).
Send Email	If you enabled this function, System can send out an email to alert you when an alarm occurs.
Tour	You need to click setup button to select tour channel. System begins 1-window or multiple-window tour display among the channel(s) you set to record when an alarm occurs. See Figure 5-59.
PTZ Activation	Here you can set PTZ movement when alarm occurs. Such as go to preset X. See Figure 5-105.
Snapshot	Click setup button to select snapshot channel. See Figure 5-60.

### 5.11.3.12.2 Net Alarm

The network alarm interface is shown as in Figure 5-106.

Network alarm refers to the alarm signal from the network. System does not anti-dither and sensor type setup. For setup information, please refer to chapter 5.11.3.12.1.

Figure 5-106

### 5.11.3.12.3 IPC external alarm

The IPC external alarm interface is shown as in Figure 5-107.

Network alarm refers to the alarm signal from the network. System does not anti-dither and sensor type setup. For setup information, please refer to chapter 5.11.3.12.1.

Local Alarm | Net Alarm | **IPC External Alarm** | IPC Offline Alarm

Enable  Alarm Name

Period

Anti-Dither  Sec.(0-600) Type

Record Channel

Post-Record  Sec.(10~300)

Alarm Out

Latch  Sec.(0~300)

PTZ Activation

Tour

Snapshot

Voice Prompts File Name

Show Message  Send Email  Alarm Upload  Buzzer  Log

Figure 5-107

### 5.11.3.12.4 IPC Offline Alarm

The IPC offline alarm interface is shown as in Figure 5-108.

System can generate an alarm once the network camera is offline. For setup information, please refer to chapter 5.11.3.12.1.

Local Alarm	Net Alarm	IPC External Alarm	IPC Offline Alarm
<input type="checkbox"/> Enable	<input type="text"/>		
<input type="checkbox"/> Record Channel	<input type="button" value="Setup"/>		
Post-Record	<input type="text" value="10"/>	Sec.(10~300)	
<input type="checkbox"/> Alarm Out	<input type="button" value="1"/> <input type="button" value="2"/> <input type="button" value="3"/> <input type="button" value="4"/> <input type="button" value="5"/> <input type="button" value="6"/>		
Latch	<input type="text" value="0"/>	Sec.(0~300)	
<input type="checkbox"/> PTZ Activation	<input type="button" value="Setup"/>		
<input type="checkbox"/> Tour	<input type="button" value="Setup"/>		
<input type="checkbox"/> Snapshot	<input type="button" value="Setup"/>		
<input type="checkbox"/> Voice Prompts	File Name	<input type="text" value="None"/>	
<input type="checkbox"/> Show Message	<input type="checkbox"/> Send Email	<input type="checkbox"/> Alarm Upload	<input type="checkbox"/> Buzzer <input type="checkbox"/> Log
<input type="button" value="Copy"/> <input type="button" value="OK"/> <input type="button" value="Refresh"/> <input type="button" value="Default"/>			

Figure 5-108

### 5.11.3.13 Abnormality

From main menu>Setup>Event>Abnormality, it includes four types: HDD/Network/User/Device. See Figure 5-109 through Figure 5-112.

HDD	Network	User	Fan
Event Type	<input type="text" value="No HDD"/>		
<input checked="" type="checkbox"/> Enable			
<input type="checkbox"/> Alarm Out	<input type="button" value="1"/> <input type="button" value="2"/> <input type="button" value="3"/> <input type="button" value="4"/> <input type="button" value="5"/> <input type="button" value="6"/>		
Latch	<input type="text" value="10"/>	Sec.(0~300)	
<input type="checkbox"/> Voice Prompts	File Name	<input type="text" value="None"/>	
<input type="checkbox"/> Show Message	<input type="checkbox"/> Send Email	<input type="checkbox"/> Alarm Upload	<input type="checkbox"/> Buzzer <input checked="" type="checkbox"/> Log
<input type="button" value="OK"/> <input type="button" value="Refresh"/>			

Figure 5-109

HDD	Network	User	Fan
Event Type <input type="text" value="Disconnect"/>			
<input checked="" type="checkbox"/> Enable			
<input type="checkbox"/> Alarm Out	<input type="button" value="1"/> <input type="button" value="2"/> <input type="button" value="3"/> <input type="button" value="4"/> <input type="button" value="5"/> <input type="button" value="6"/>		
Latch	<input type="text" value="10"/>	Sec.(0~300)	
<input type="checkbox"/> Voice Prompts	File Name	<input type="text" value="None"/>	
<input type="checkbox"/> Show Message	<input type="checkbox"/> Send Email	<input type="checkbox"/> Buzzer	<input checked="" type="checkbox"/> Log
<input type="button" value="OK"/>		<input type="button" value="Refresh"/>	

Figure 5-110

HDD	Network	User	Fan
Event Type <input type="text" value="Illegal Login"/>			
<input checked="" type="checkbox"/> Enable			
Attempt(s)	<input type="text" value="5"/>	Times (1~10)	
Lock Time	<input type="text" value="5"/>	Min. (1~30)	
<input type="checkbox"/> Alarm Out	<input type="button" value="1"/> <input type="button" value="2"/> <input type="button" value="3"/> <input type="button" value="4"/> <input type="button" value="5"/> <input type="button" value="6"/>		
Latch	<input type="text" value="10"/>	Sec.(0~300)	
<input type="checkbox"/> Voice Prompts	File Name	<input type="text" value="None"/>	
<input type="checkbox"/> Send Email	<input type="checkbox"/> Buzzer	<input checked="" type="checkbox"/> Log	
<input type="button" value="OK"/>		<input type="button" value="Refresh"/>	

Figure 5-111

Figure 5-112

Please refer to the following sheet for detailed information.

Parameter	Function
Event Type	The abnormal events include: HDD: No disk, disk error, disk no space; <ul style="list-style-type: none"> <li>● Network: Net disconnection, IP conflict, MAC conflict.</li> <li>● User: Illegal login.</li> <li>● Device: Temperature is too high, fan speed is abnormal. Please note this function is for some series product only.</li> <li>● You can set one or more items here.</li> <li>● Less than: You can set the minimum percentage value here. The device can generate an alarm when capacity is not sufficient. This item is for disk no space type only.</li> </ul>
Enable	Check the box here to enable selected function.
Alarm Out	Please select corresponding alarm output channel when an alarm occurs. You need to check the box to enable this function.
Latch	The alarm output can delay for the specified time after an alarm stops. The value ranges from 0s to 300s. The default setup is 10 seconds. The 0 second means there is no delaying time.
Attempt(s)	It is to set login attempt times. Once the login attempt exceeds the threshold you set here, current account will be locked. This function is for illegal login only.
Lock time	It is to set account lock time once its login attempt has exceeded the threshold you set. This function is for illegal login only.
Show message	System can pop up a message to alarm you in the local host screen if you enabled this function.
Alarm upload	System can upload the alarm signal to the center (Including alarm center).

Parameter	Function
Send Email	If you enabled this function, System can send out an email to alert you when an alarm occurs.
Buzzer	Check the box here to enable this function. The buzzer beeps when an alarm occurs.
Log	Check the box here, system can record the network event alarm log.

### 5.11.3.14 Alarm Out

The alarm output interface is shown as below. See Figure 5-113  
 Here you can set alarm output mode: auto/manual/stop.

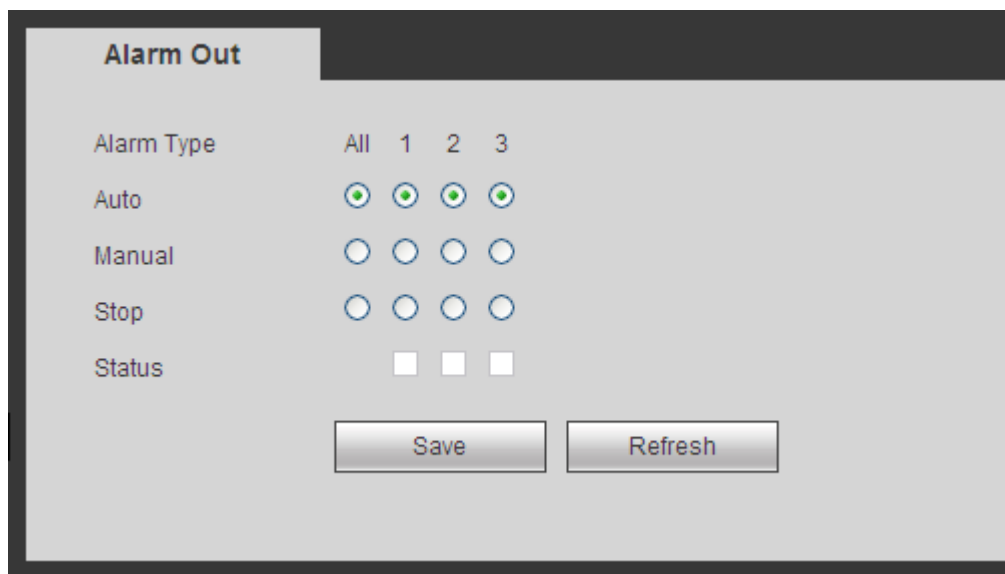

Figure 5-113

## 5.11.4 Storage

### 5.11.4.1 Basic

It is to manage HDD storage space.

Step 1 From main menu>Setup>Storage>Basic.

Enter Basic interface. See Figure 5-39.

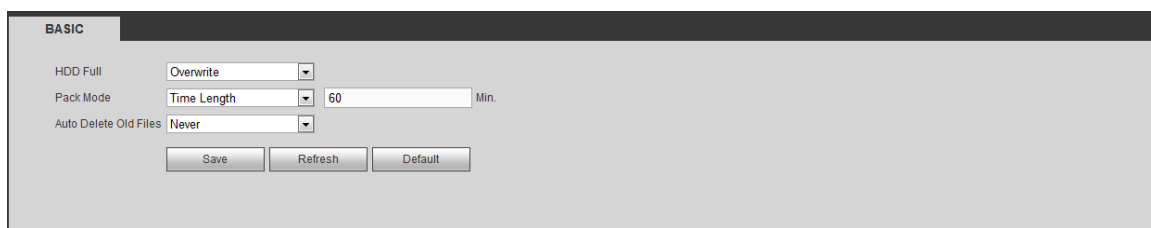

Figure 5-114



Step 2 Set parameters.

Parameter	Function
HDD full	It is to select working mode when hard disk is full. There are two options: stop recording or rewrite. <ul style="list-style-type: none"><li>● Stop: If current HDD is full while there is no idle HDD, then system stops recording,</li><li>● Overwrite: If the current HDD is full while there is no idle HDD, then system overwrites the previous files.</li></ul>
Pack duration	It is to specify record duration. The max value is 120 minutes.
Auto delete old files	<ul style="list-style-type: none"><li>● Never: Do not auto delete old files.</li><li>● Customized: input customized period here, system can auto delete corresponding old files</li></ul>

### 5.11.4.2 Schedule

In this interfaces, you can add or remove the schedule record setup. See Figure 5-115.

There are four record modes: general (auto), motion detect, alarm and MD&alarm. There are six periods in one day.

You can view the current time period setup from the color bar.

- Green color stands for the general record/snapshot.
- Yellow color stands for the motion detect record/snapshot..
- Red color stands for the alarm record/snapshot.
- Blue color stands for MD&alarm record/snapshot.

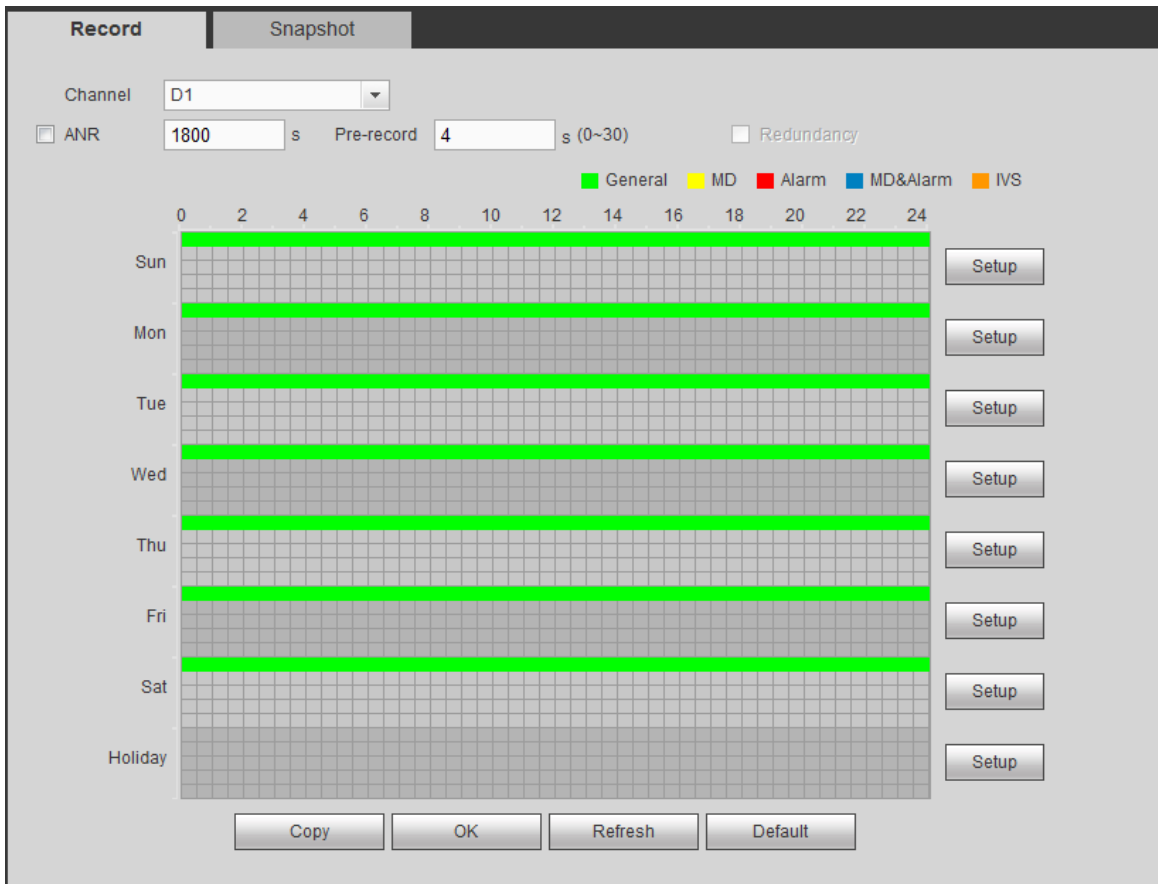

Figure 5-115

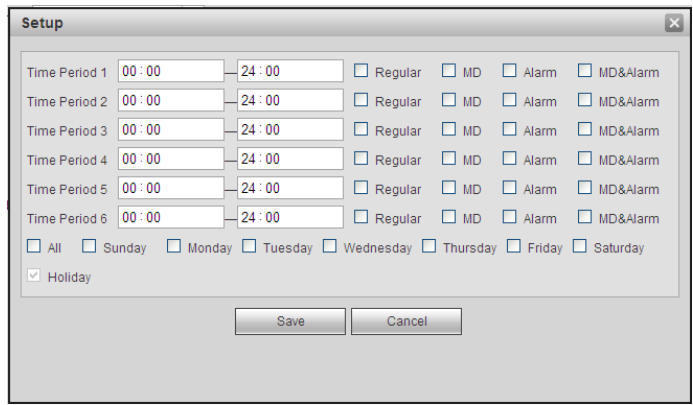

Figure 5-116

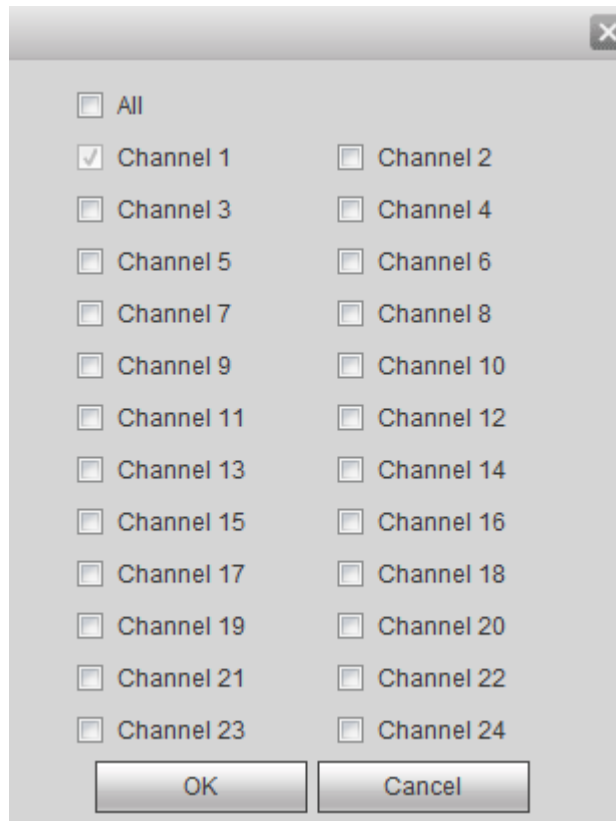

Figure 5-117

Please refer to the following sheet for detailed information.

Parameter	Function
Channel	Please select a channel from the dropdown list.
Pre-record	Please input pre-record time here. The value ranges from 0 to 30.
Redundancy	Check the box here to enable redundancy function. <b>Please note this function is null if there is only one HDD.</b>
Snapshot	Check the box here to enable snapshot function.
Holiday	Check the box here to enable holiday function.
Setup	Click the Setup button, you can set record period. See Figure 5-116. There are six periods in one day. If you do not check the date at the bottom of the interface, current setup is for today only. Please click Save button and then exit.
Copy	Copy function allows you to copy one channel setup to another. After setting in channel, click Copy button, you can go to interface Figure 5-117. You can see current channel name is grey such as channel 1. Now you can select the channel you want to paste such as channel 5/6/7. If you want to save current setup of channel 1 to all channels, you can click the first box "ALL". Click the OK button to save current copy setup. Click the OK button in the Encode interface, the copy function succeeded.

## 5.11.4.3 HDD Manager

### 5.11.4.3.1 Local Storage

The local interface is shown as in Figure 5-118. Here you can see HDD information. You can also operate the read-only, read-write, redundancy (if there are more than on HDD) and format operation.

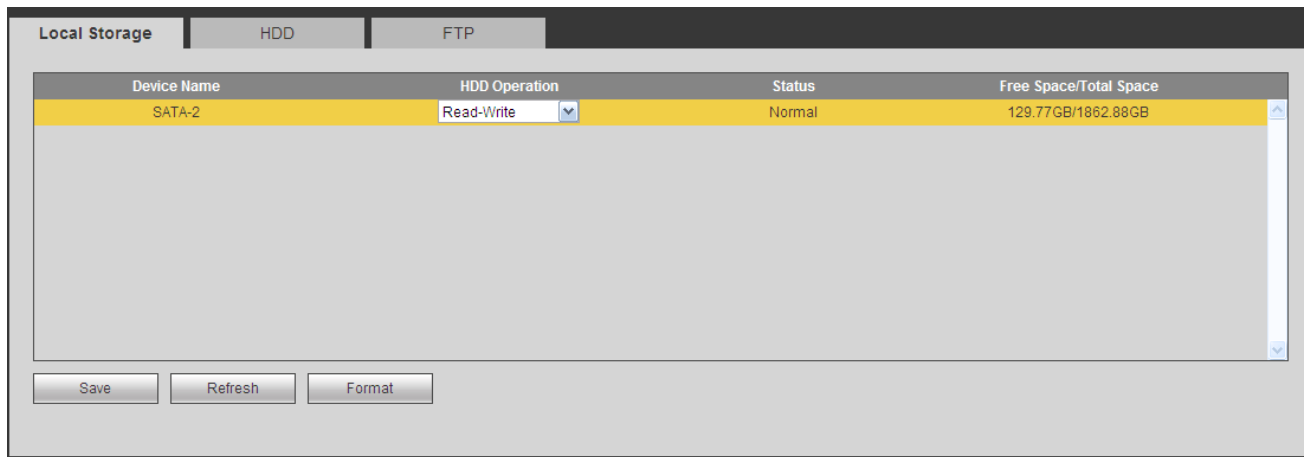

Figure 5-118

### 5.11.4.3.2 HDD

The HDD interface is to set HDD group. See Figure 5-119.

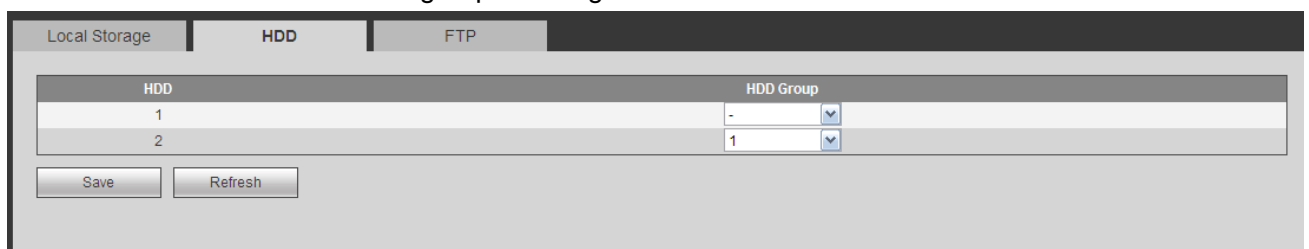

Figure 5-119

### 5.11.4.3.3 FTP

The FTP interface is to set FTP information. See Figure 5-120.

Please set the FTP as your remote storage location. System can save record file or snapshot picture to the FTP once the network is offline or malfunction.

Local Storage	HDD	FTP
<input checked="" type="checkbox"/> Enable		
Host IP	0 . 0 . 0 . 0 *	
Port	21 *	
User Name	<input type="text"/>	
Password	<input type="text"/>	<input type="checkbox"/> Anonymous
Remote Directory	<input type="text"/>	
File Length	0	M
Image Upload Interval	2	Second
Channel	1	
Weekday	Tuesday	
Period 1	00 : 00 - 24 : 00	<input type="checkbox"/> Alarm <input type="checkbox"/> MD <input type="checkbox"/> Regular
Period 2	00 : 00 - 24 : 00	<input type="checkbox"/> Alarm <input type="checkbox"/> MD <input type="checkbox"/> Regular
<input type="button" value="Test"/> <input type="button" value="Save"/> <input type="button" value="Refresh"/> <input type="button" value="Default"/>		

Figure 5-120

#### 5.11.4.4 Record Control

The interface is shown as in Figure 5-121.

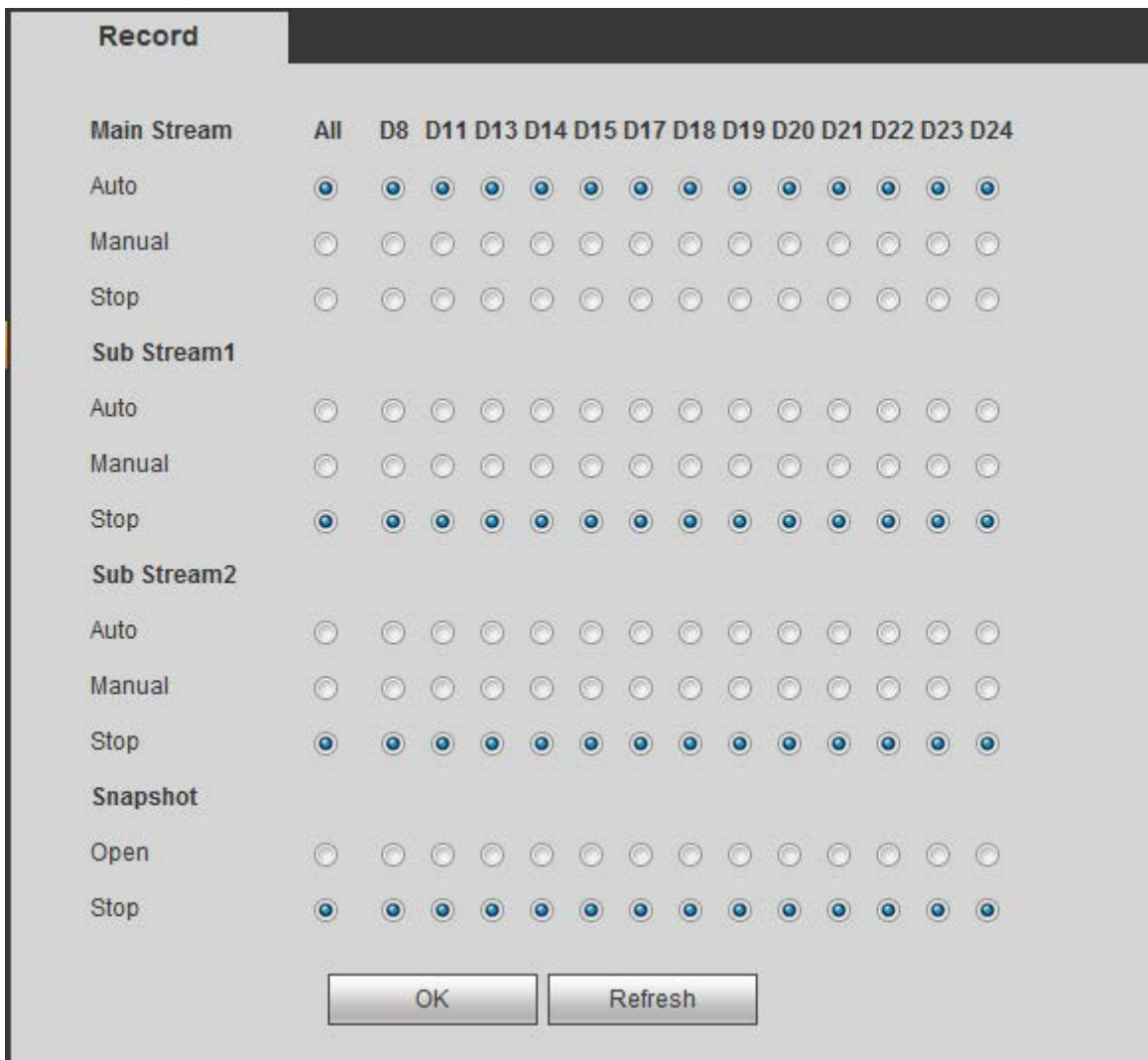

Figure 5-121

Please refer to the following sheet for detailed information.

Parameter	Function
Channel	Here you can view channel number. The number displayed here is the max channel amount of your device.
Status	There are three statuses: schedule, manual and stop.
Schedule	System enables auto record function as you set in record schedule setup (general, motion detect and alarm).
Manual	It has the highest priority. Enable corresponding channel to record no matter what period applied in the record setup.
Stop	Stop current channel record no matter what period applied in the record setup.
Start all/ stop all	Check the corresponding All button, you can enable or disable all channels record.

## 5.11.4.5 RAID Manager

### Important

Please make sure your purchased product support the RAID function, otherwise you cannot see the following interface.

RAID (redundant array of independent disks) is a data storage virtualization technology that combines multiple physical HDD components into a single logical unit for the purposes of data redundancy, performance improvement, or both.



### Note

- RAID function is for some series product only. Slight difference may be found on the user interface.
- Right now, NVR supports RAID0, RAID1, RAID5, RAID6, and RAID 10. Local hotspare supports RAID1, RAID5, RAID6, and RAID10.
- Refer to the following table for detailed information.

RAID Type	HDD Amount
RAID0	At least 2 HDDs.
RAID1	Only 2 HDDs.
RAID5	At least 3 HDDs. Usually recommend the RAID5 consists of 4 to 6 HDDs.
RAID6	At least 4 HDDs.
RAID10	At least 4 HDDs.

### 5.11.4.5.1 RAID Config

It is for you to manage RAID HDD. It can display RAID name, type, free space, total space, status and etc. Here you can add/delete RAID HDD.

Click Add button to select RAID type and then select HDDs, click OK button to add. See Figure 5-122.

#### One click to create RAID

- Click it to automatically create RAID5.
- For create RAID function, you can select the physical HDD that does not included in the RAID group or the created disk array to create a RAID5. You can refer to the following situations:
- There is no RAID, no hotspare disk: System directly creates the RAID5 and creates one hotspare disk at the same time.
- There is no RAID, but there is a hotspare disk: System creates the RAID5 only. It uses previous hotspare disk.
- There is RAID: System cancel the previous RAID setup and then create the new RAID5. System creates the hotspare disk if there is no one. System uses previous hotspare disk if there is hotspare disk available.
- The background will format the virtual disk.

#### Create manually

Step 4 Select RAID type first and then follow the prompts to set HDD amount.

Step 5 Click Create Manually button, system pops up dialogue box to warning you it is going to clear all data.

Step 6 Click OK button to complete the operation.



### Note

Click  to delete RAID.

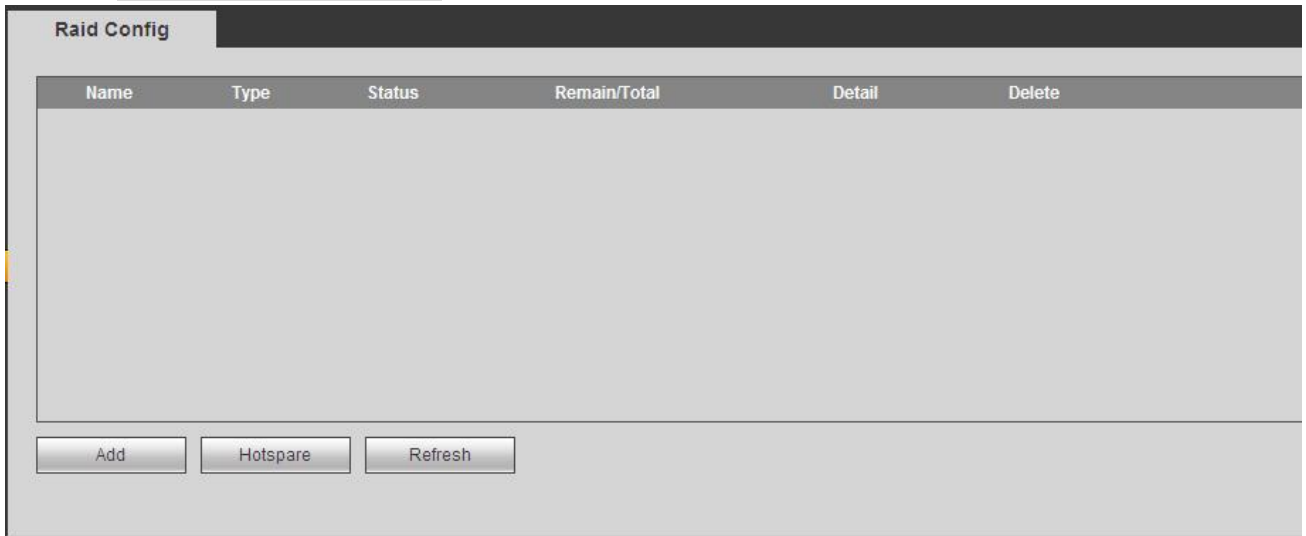

Figure 5-122

#### 5.11.4.5.2 Hotspare disks

In Figure 5-122, click hotspare button, you can add the hot spare HDD. See Figure 5-123. The type includes two options:

- Global: It is global hotspare disk. When any RAID becomes degrading, it can replace and build the RAID.
- Local: It is local hotspare disk. When the specified RAID becomes degrading, it can replace and build the RAID.

Select a hot spare device and then click Delete button. Click Apply button to delete.

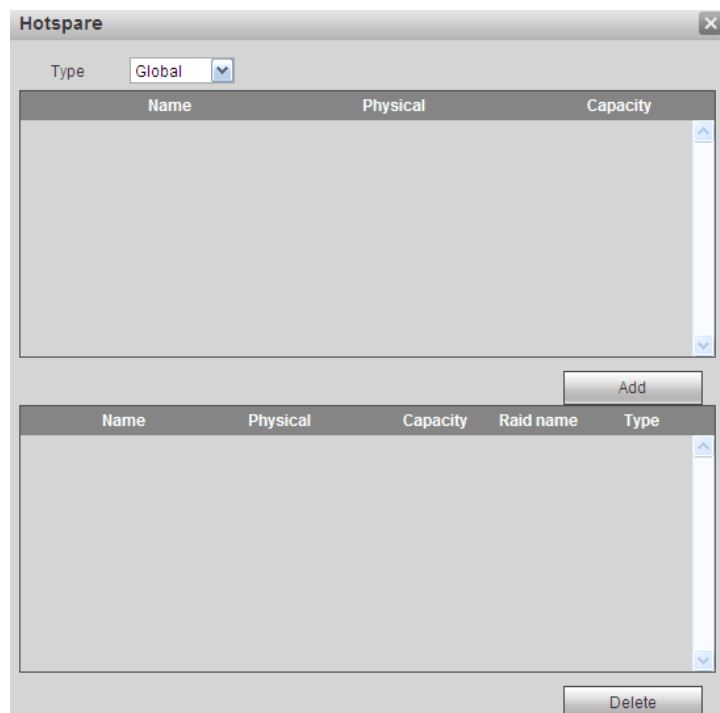

Figure 5-123



## 5.11.4.6 Storage

### 5.11.4.6.1 Main Stream

The main stream interface is shown as in Figure 5-124. Here you can set corresponding HDD group to save main stream.

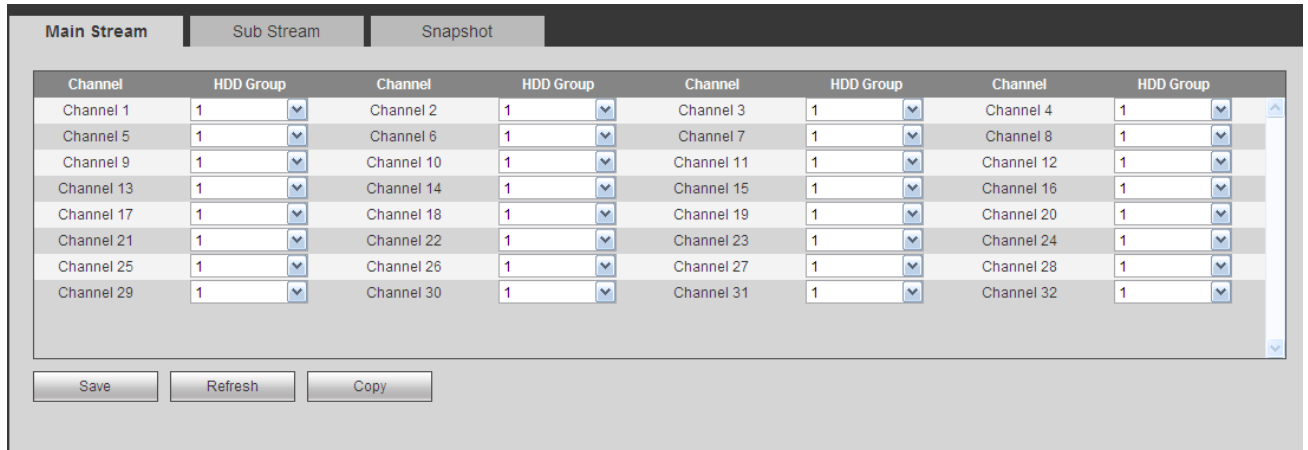

The screenshot shows the 'Main Stream' tab selected. It contains a table with 32 channels, each with a corresponding 'HDD Group' dropdown menu. All dropdowns are currently set to '1'. Below the table are three buttons: 'Save', 'Refresh', and 'Copy'.

Channel	HDD Group	Channel	HDD Group	Channel	HDD Group	Channel	HDD Group
Channel 1	1	Channel 2	1	Channel 3	1	Channel 4	1
Channel 5	1	Channel 6	1	Channel 7	1	Channel 8	1
Channel 9	1	Channel 10	1	Channel 11	1	Channel 12	1
Channel 13	1	Channel 14	1	Channel 15	1	Channel 16	1
Channel 17	1	Channel 18	1	Channel 19	1	Channel 20	1
Channel 21	1	Channel 22	1	Channel 23	1	Channel 24	1
Channel 25	1	Channel 26	1	Channel 27	1	Channel 28	1
Channel 29	1	Channel 30	1	Channel 31	1	Channel 32	1

Figure 5-124

### 5.11.4.6.2 Sub Stream

The sub stream interface is shown as in Figure 5-125. Here you can set corresponding HDD group to save sub stream.

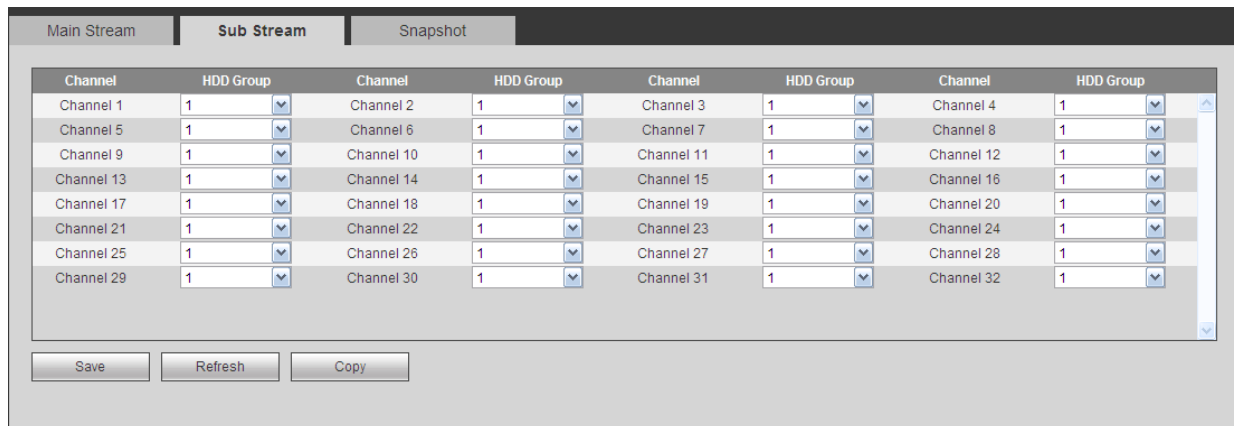

The screenshot shows the 'Sub Stream' tab selected. It contains a table with 32 channels, each with a corresponding 'HDD Group' dropdown menu. All dropdowns are currently set to '1'. Below the table are three buttons: 'Save', 'Refresh', and 'Copy'.

Channel	HDD Group	Channel	HDD Group	Channel	HDD Group	Channel	HDD Group
Channel 1	1	Channel 2	1	Channel 3	1	Channel 4	1
Channel 5	1	Channel 6	1	Channel 7	1	Channel 8	1
Channel 9	1	Channel 10	1	Channel 11	1	Channel 12	1
Channel 13	1	Channel 14	1	Channel 15	1	Channel 16	1
Channel 17	1	Channel 18	1	Channel 19	1	Channel 20	1
Channel 21	1	Channel 22	1	Channel 23	1	Channel 24	1
Channel 25	1	Channel 26	1	Channel 27	1	Channel 28	1
Channel 29	1	Channel 30	1	Channel 31	1	Channel 32	1

Figure 5-125

### 5.11.4.6.3 Snapshot

The snapshot interface is shown as in Figure 5-126. Here you can set corresponding HDD group to save snapshot picture.

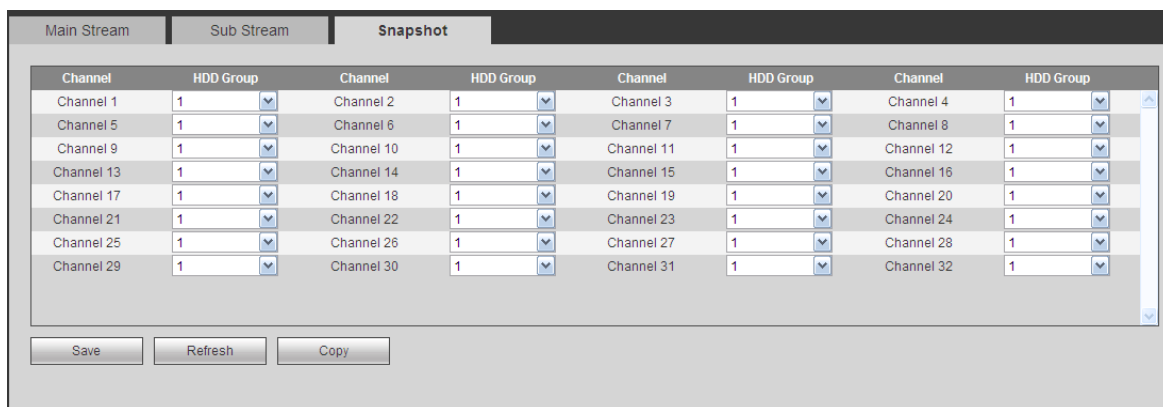

Figure 5-126

## 5.11.5 Setting

### 5.11.5.1 General

The general interface includes general, date/time and holiday setup.

#### 5.11.5.1.1 General

The general interface is shown as in Figure 5-127.

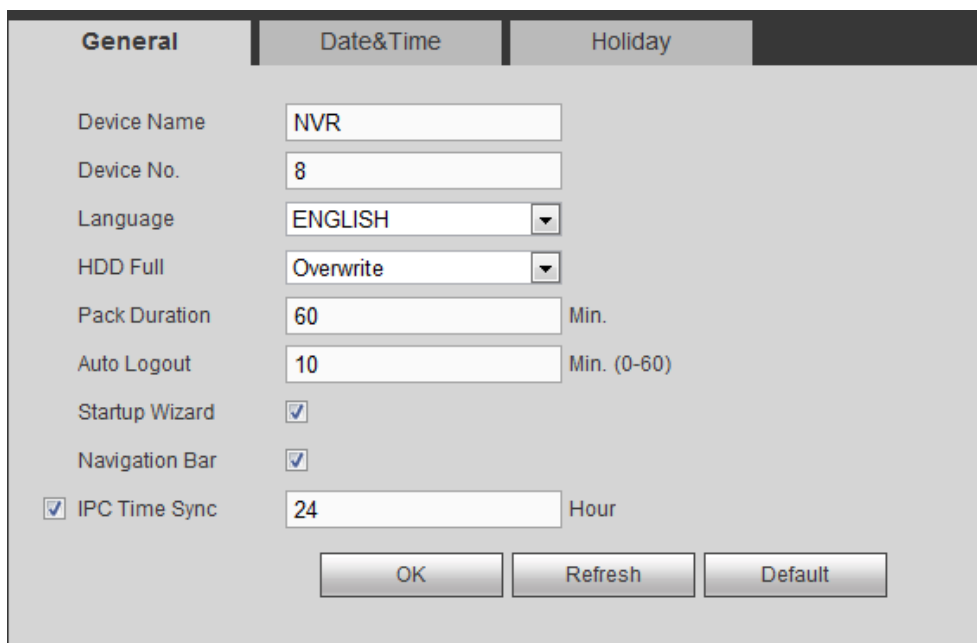

Figure 5-127

Please refer to the following sheet for detailed information.

Parameter	Function
Device ID	It is to set device name.
Device No.	It is device channel number.

Language	You can select the language from the dropdown list. Please note the device needs to reboot to get the modification activated.
Video Standard	This is to display video standard such as PAL.
Auto logout	Here is for you to set auto logout interval once login user remains inactive for a specified time. Value ranges from 0 to 60 minutes.
IPC Time Sync	You can input an interval here to synchronize the DVR time and IPC time.
Navigation bar	Check the box here, system displays the navigation bar on the interface.

### 5.11.5.1.2 Date and time

The date and time interface is shown as in Figure 5-128

Figure 5-128

Please refer to the following sheet for detailed information.

Parameter	Function
Date format	Here you can select date format from the dropdown list.
Time Format	There are two options: 24-H and 12-H.
Time zone	The time zone of the device.
System time	It is to set system time. It becomes valid after you set.

Sync PC	You can click this button to save the system time as your PC current time.
DST	Here you can set day night save time begin time and end time. You can set according to the date format or according to the week format.
NTP	You can check the box to enable NTP function.
NTP server	You can set the time server address.
Port	It is to set the time server port.
Interval	It is to set the sync periods between the device and the time server.

### 5.11.5.1.3 Holiday Setup

Holiday setup interface is shown as in Figure 5-129.

Here you can click Add holidays box to add a new holiday and then click Save button to save.

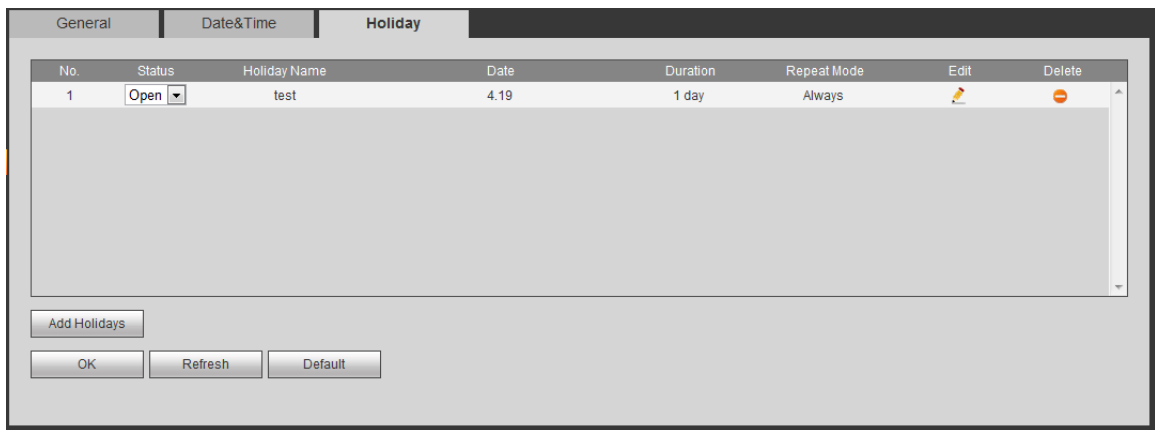

Figure 5-129

## 5.11.5.2 Display

Display interface includes GUI, TV adjust, Tour and Customized split.

### 5.11.5.2.1 Display



NOTE

Due to the port of each device is different, the display output screen mode is also different. See the actual interface.

Set the display effect of the device preview interface, including image output display mode, OSD display, etc.

Step 1 Select Setup > System > Display > Display.

The Display interface is displayed. See Figure 5-130.

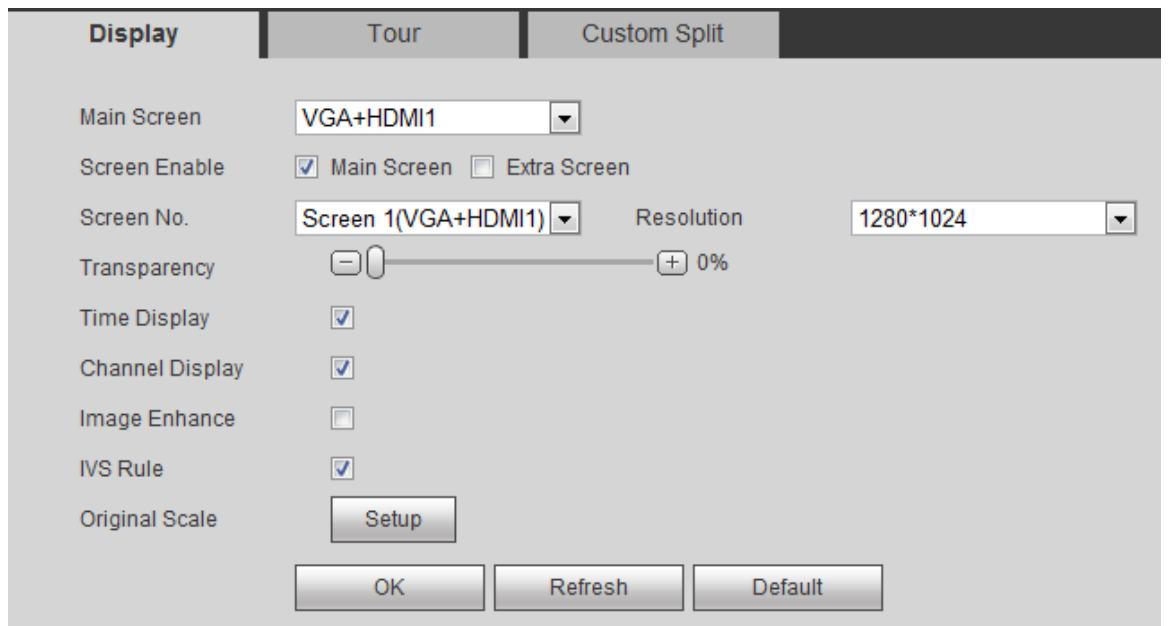

Figure 5-130

Step 2 Configure the parameters. For details, see the following table.

Parameter	Description
Main Screen	You can select VGA+HDMI1 or HDMI2.
Screen Enable	Select the check box to enable the corresponding screen. System can display the image only when the screen is enabled.
Screen No.	Select the screen number you need to set the resolution.
Resolution	The system supports 1920×1080, 1280×1024, 1280×720 and 3840×2160. After the modified resolution is saved, it will take effect after restarting the device. The default resolution is 1280×1024. NOTE Only some devices support 3840×2160. See the actual situation.
Color Mode	Set the image color. You can select it in the drop-down list. NOTE Only some devices support this function. See the actual situation.
Transparency	The greater the value of transparency, the more transparent the device local menu.
Time Display / Channel Display	Select the check box and system displays the date, time and channel number on the preview screen.
Image Enhance	Select the check box to optimize preview image edges.
IVS Rule	Select the check box to display the specified IVS rule settings on the preview screen. NOTE Only some devices support this function. See the actual situation.
Original Scale	Click Setup, select the channel, and then click OK to restore the image in the selected channel to the original scale.

Step 3 Click OK to save the setting.

### 5.11.5.2.2 Tour

The tour interface is shown as in Figure 5-131. Here you can set tour interval, split mode, motion detect tour and alarm tour mode.

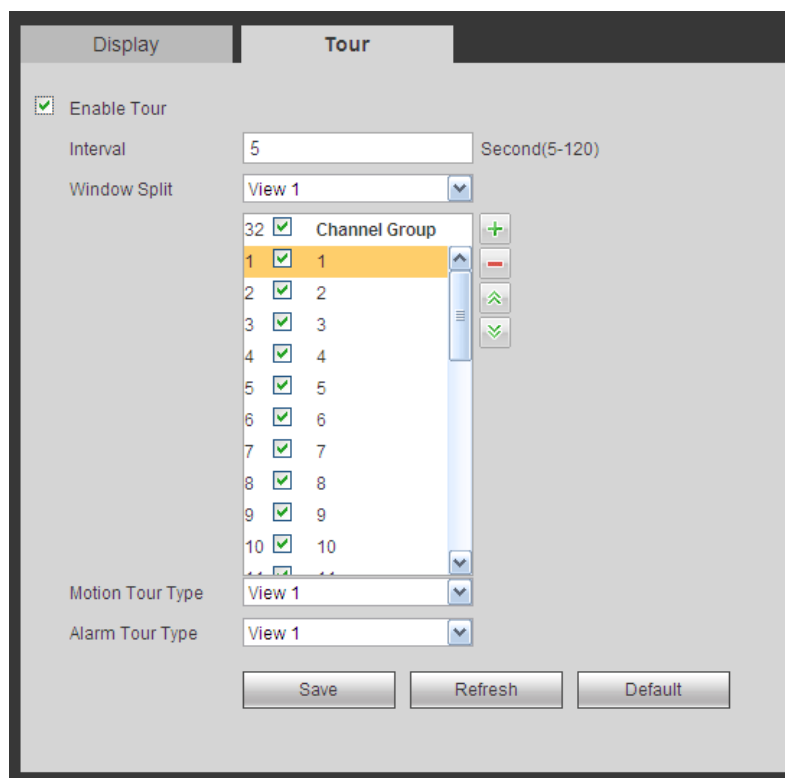

Figure 5-131

Please refer to the following sheet for detailed information.

Parameter	Function
Enable tour	Check the box here to enable tour function.
Interval	Here is for you to adjust transparency. The value ranges from 5 to 120s. The default setup is 5s.
Split	Here you can set window mode and channel group. System can support 1/4/8/9/16/25/36-window according to device channel amount.
Motion tour/Alarm tour	Here you can set motion detect tour/alarm tour window mode. System supports 1/8-window now.

### 5.11.5.2.3 Custom Split

From main menu>Setup>System>Display>Custom split, the interface is shown as in Figure 5-132. Here you can set customized split mode.

#### Note

- This function is for some series products. Please refer to the actual product for detailed information.
- Device max supports 5 customized videos.

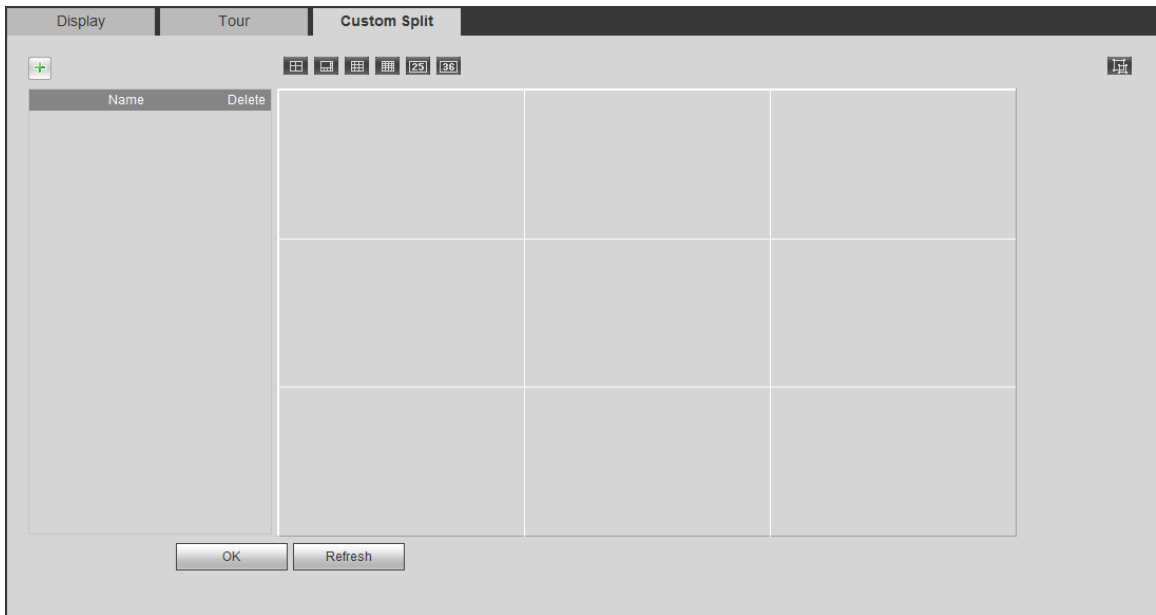



Figure 5-132

Click  and then click      to select basic mode

In regular mode, drag the mouse in the preview frame, you can merge several small windows to one window so that you can get your desired split mode.

After the setup, the selected window has the red frame.

Select the merging window, the frame is red; you can click  to cancel the merge to restore regular mode.

Click OK to exit.

### 5.11.5.3 RS232

The RS232 interface is shown as in Figure 5-133.

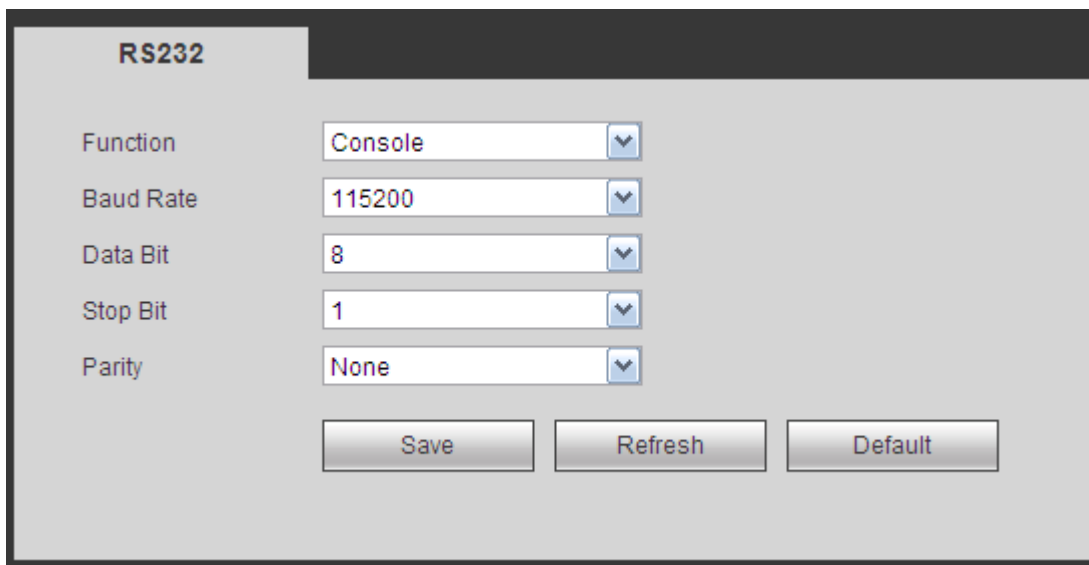

Figure 5-133

Please refer to the following sheet for detailed information.

Parameter	Function
Protocol	Select the corresponding dome protocol. Default setup is console.
Baud Rate	Select the baud rate. Default setup is 115200.
Data Bit	The value ranges from 5 to 8. Default setup is 8.
Stop bit	There are two options: 1/2. Default setup is 1.
Parity	There are five options: none/odd/even/space/mark. Default setup is none.

### 5.11.5.4 PTZ

The PTZ interface is shown as in Figure 5-134 (Local) and Figure 5-135 (Remote).

Before setup, please check the following connections are right:

- PTZ and decoder connection is right. Decoder address setup is right.
- Decoder A (B) line connects with NVR A (B) line.

Click Save button after you complete setup, you can go back to the monitor interface to control speed dome.

The screenshot shows the PTZ configuration interface for a Local setup. The fields are as follows:

Channel	2
PTZ Type	Local
Protocol	PELCOD
Address	1
Baud Rate	9600
Data Bit	8
Stop Bit	1
Parity	None

Buttons: Copy, Save, Refresh, Default

Figure 5-134

The screenshot shows the PTZ configuration interface for a Remote setup. The fields are as follows:

Channel	1
PTZ Type	Remote

Buttons: Copy, Save, Refresh, Default



Figure 5-135

Please refer to the following sheet for detailed information.

Parameter	Function
Channel	Select speed dome connected channel.
PTZ Type	There are two options: local/remote. Please select remote type if you are connecting to the network PTZ. Please select local type if you are using RS485 to the PTZ camera.
Protocol	Select the corresponding dome protocol such as PELCOD.
Address	Set corresponding dome address. Default value is 1. <b>Please note your setup here shall comply with your dome address; otherwise you cannot control the speed dome.</b>
Baud Rate	Select the dome baud rate. Default setup is 9600.
Data Bit	The value ranges from 5 to 8. Default setup is 8. Please set according to the speed dome dial switch setup.
Stop bit	The value ranges from 1 to 2. Default setup is 1. Please set according to the speed dome dial switch setup.
Parity	The options include non/odd/even/space/null. Default setup is none. Please set according to the speed dome dial switch setup.

### 5.11.5.5 POS

Connect the NVR to the POS, it can receive the POS information and overlay on the corresponding record.

**Note**

POS info overlay and playback function is for 1-window only.

From main menu>Setting>System>POS, you can go to the following interface. See Figure 5-136.

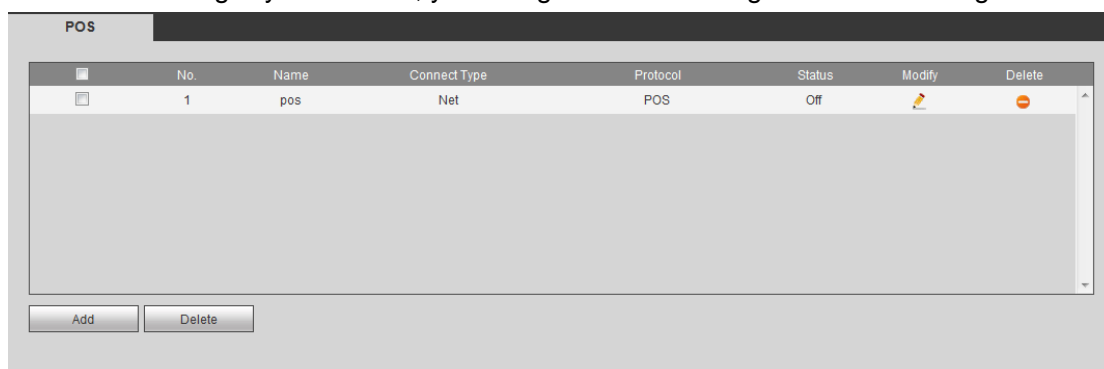

Figure 5-136

Click Add, you can see the following dialogue box. See Figure 5-137.

Figure 5-137

Check the box to enable POS function, Click Set button; you can see the following interface. See Figure 5-138.

Figure 5-138

Set source IP and destination IP, and then click OK. System goes back to Figure 5-137.

- Source IP: POS device IP address.
- Destination IP: NVR IP address.

In Figure 5-137, click Channel Set button, select the channel you want to overlay POS information. Click OK button to complete the setup.

#### Tips



: Click it to delete POS setup.



: Click it to change setup information.

### 5.11.5.6 Voice

The audio function is to manage audio files and set schedule play function. It is to realize audio broadcast activation function.

#### 5.11.5.6.1 File List

From main menu>Setup>System>Voice>File list, here you can add audio file, or delete audio file. See Figure 5-139.

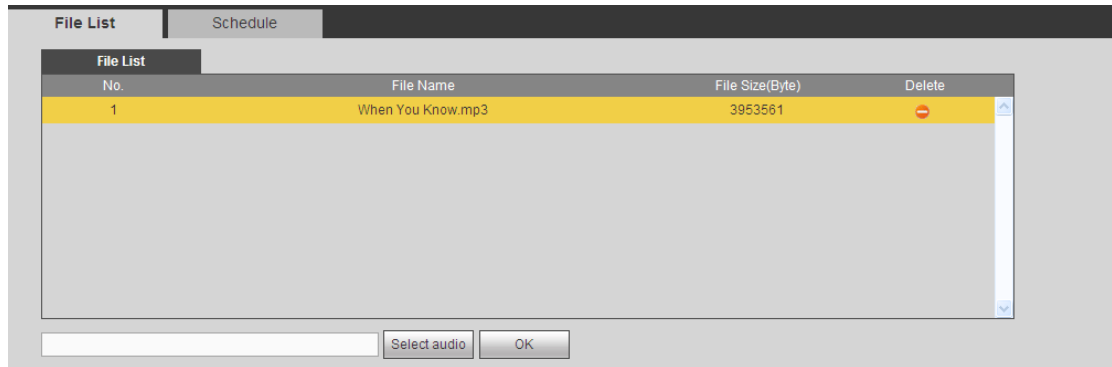

Figure 5-139

Click Add button, you can add audio file and import the audio file via the local computer. See Figure 5-140.

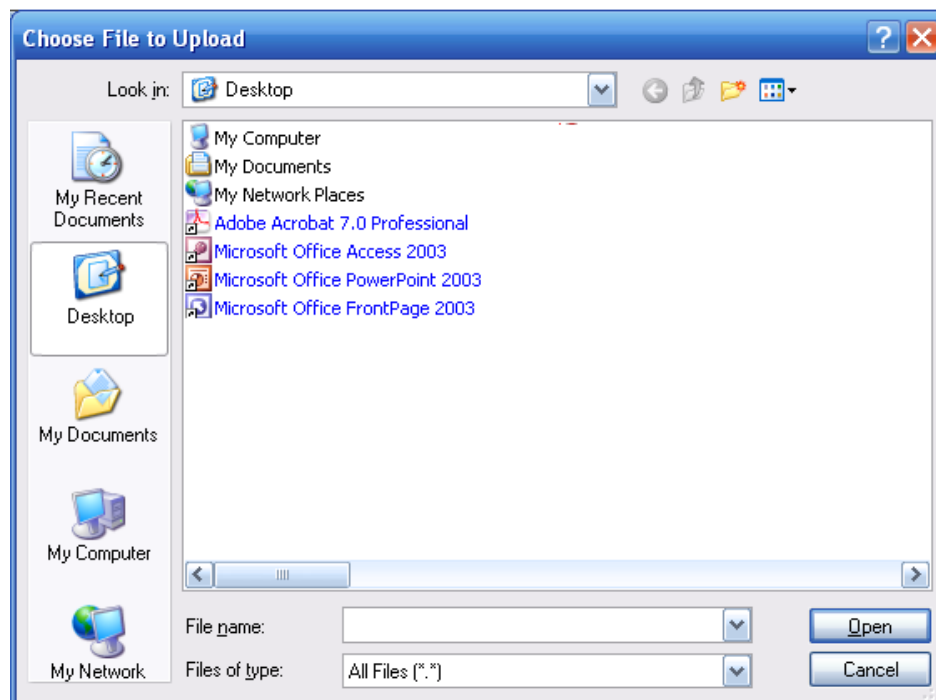

Figure 5-140

#### 5.11.5.6.2 Schedule

It is to set schedule broadcast function. You can play the different audio files in the specified periods.

From main menu>Setup>System>Voice>.Schedule, you can see the following interface. See Figure 5-141.

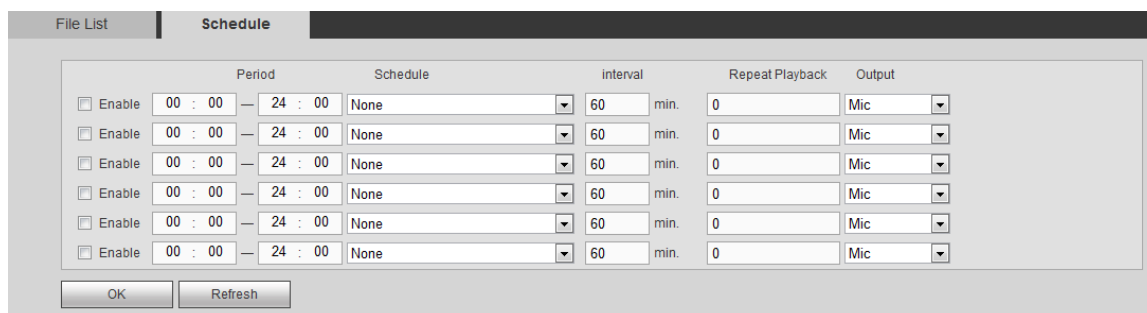

Figure 5-141

Please refer to the following sheet for detailed information.

Parameter	Function
Period	There are six periods. Check the box to enable current setup.
Repeat	It is to set audio file repeat times in the specified period.
Interval	It is the audio file repeated interval in the specified period.
Output port	There are two options: MIC (default)/audio. When reuse the MIC port and bidirectional talk port, the bidirectional port has the higher priority. Please note some series product does not support audio function.



**Note**

- The audio file end time depends on the audio file size and the interval setup.
- Priority: Bidirectional talk>Event trigger alarm>Trial listening>Audio schedule broadcast.

### 5.11.5.7 Account



**Note**

- For the user name, the string max length is 31-byte, and for the user group, the string max length is 15-byte. The user name can only contain English letters, numbers and “\_”、“@”、“.”.
- The default user amount is 64 and the default group amount is 20. System account adopts two-level management: group and user. The user authorities shall be smaller than group authorities (The **admin** user authorities are set by default).
- For group or user management, there are two levels: admin and user. The user name shall be unique and one user shall only belong to one group.

#### 5.11.5.7.1 User name

From main menu>Setup>System>Account>Account, enter account interface. See Figure 5-142.

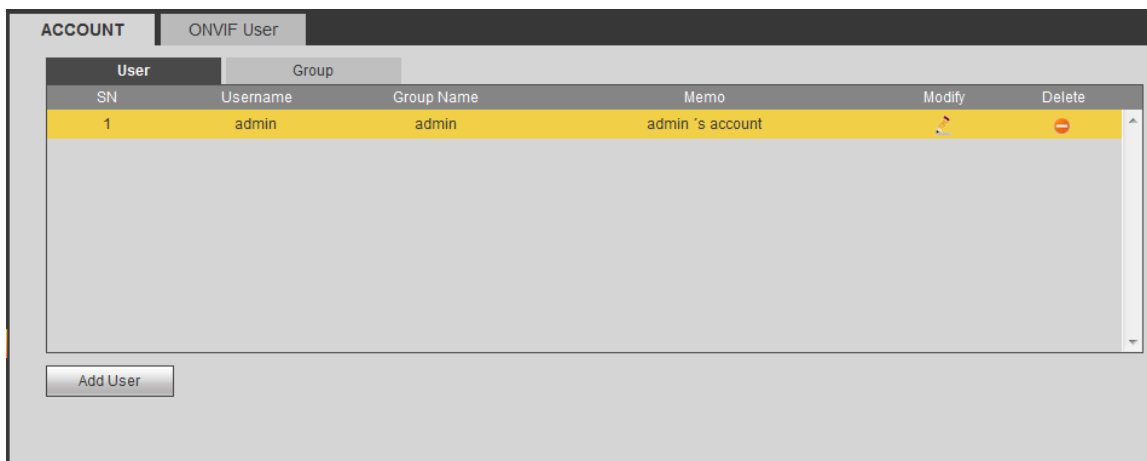

Figure 5-142

### Add user

It is to add a name to group and set the user rights.

Step 1 Click Add user button.

Enter add user interface. See Figure 5-143.

Step 2 Here you can input the user name and password and then select one group for current user.

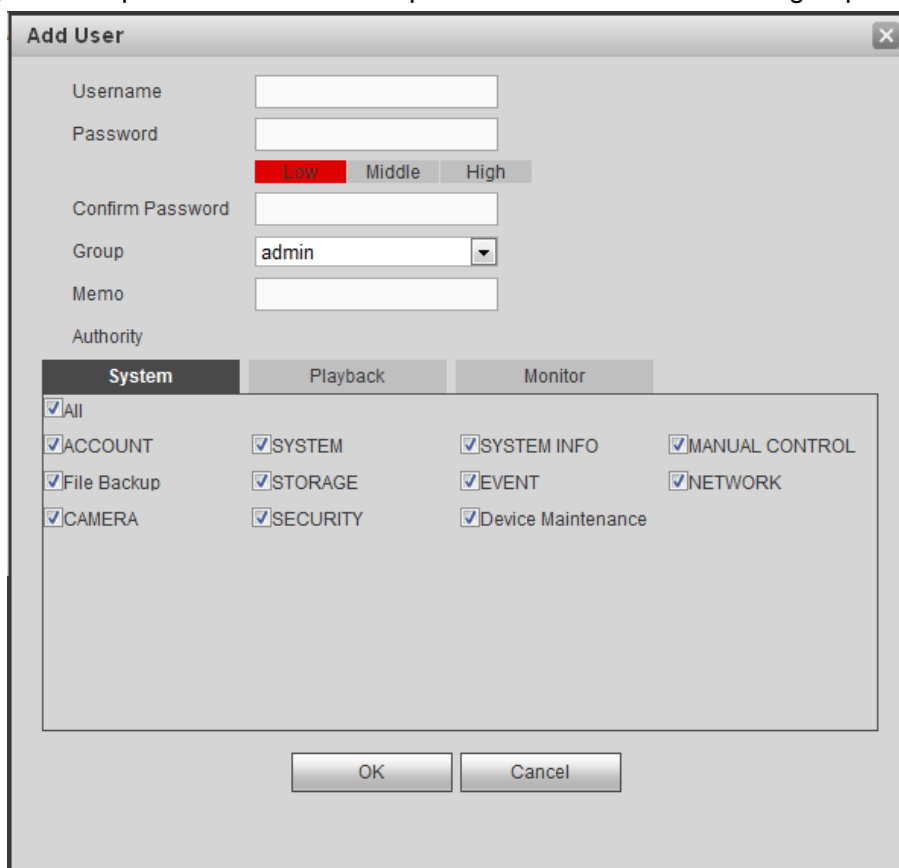

Figure 5-143

Step 3 Click the Set button after the period. It is to set valid period to use current account. See Figure 5-144.

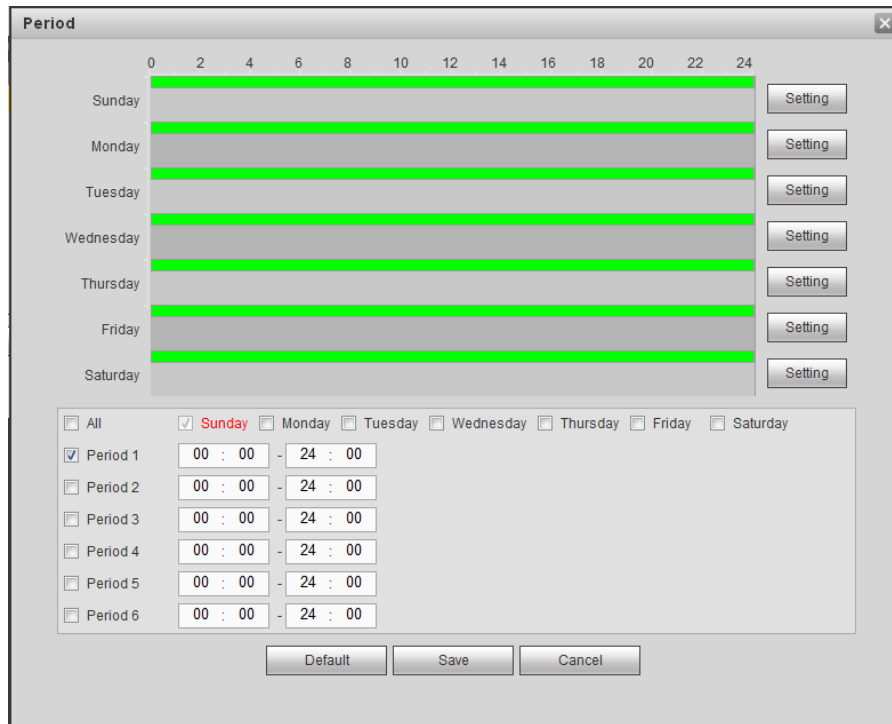

Figure 5-144

- Click Setting to set the periods. Or you can draw on the interface directly. There are six periods in one day. Or you can input start time and end time directly.
- Check the box before the date, the settings are for the selected date(s).
- Check the box before the period1-6, it is to enable the period function.

Step 4 Click Save to complete the setup.

 **Note**

Please note the user rights shall not exceed the group right setup. For convenient setup, please make sure the general user has the lower rights setup than the admin.

**Modify user**

It is to modify the user property, belonging group, password and rights. See Figure 5-145.

**User**

Username: admin

Group: admin

Memo: admin 's account

Modify Password

Email Address:

Authority

System	Playback	Monitor
<input checked="" type="checkbox"/> All		
<input checked="" type="checkbox"/> ACCOUNT	<input checked="" type="checkbox"/> SYSTEM	<input checked="" type="checkbox"/> SYSTEM INFO
<input checked="" type="checkbox"/> File Backup	<input checked="" type="checkbox"/> STORAGE	<input checked="" type="checkbox"/> EVENT
<input checked="" type="checkbox"/> CAMERA	<input checked="" type="checkbox"/> SECURITY	<input checked="" type="checkbox"/> Device Maintenance
		<input checked="" type="checkbox"/> MANUAL CONTROL
		<input checked="" type="checkbox"/> NETWORK

OK Cancel

Figure 5-145

 **Note**

For admin, you can change the email information. See Figure 5-146.

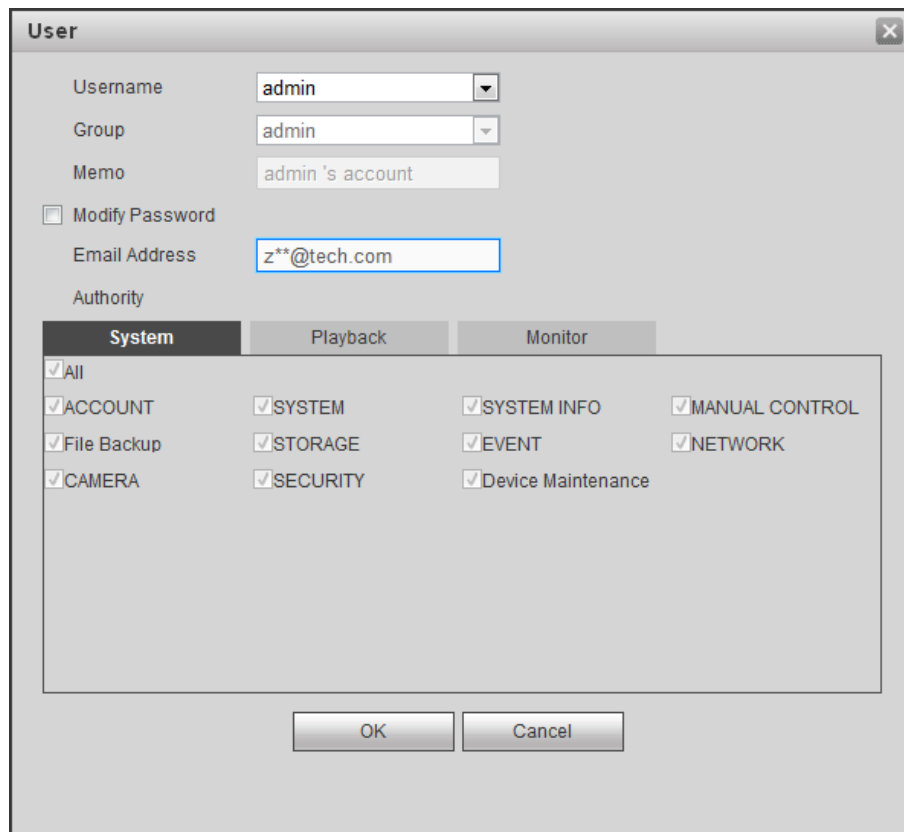

Figure 5-146

### Modify password

It is to modify the user password.

Step 1 In Modify user interface, click Modify password box. See Figure 5-147.



Figure 5-147

- Step 2 Input old password, and then input new password and confirm.  
 Step 3 Click Save button.



**Note**

The password ranges from 8 to 32 digitals. It can contain letters, numbers and special characters (excluding “” , “” , “ , ” , “ : ” , “ & ”) . The password shall contain at least two categories. Usually we recommend the strong password.



**CAUTION**

**STRONG PASSWORD RECOMMENDED**-For your device own safety, please create a strong password of your own choosing. We also recommend you change your password periodically especially in the high security system.

**5.11.5.7.2 Group**

It is to add/remove group, modify group password and etc.  
 From main menu > Setup > System > Account > Account.  
 Click Group tab, the interface is shown as in Figure 5-148.

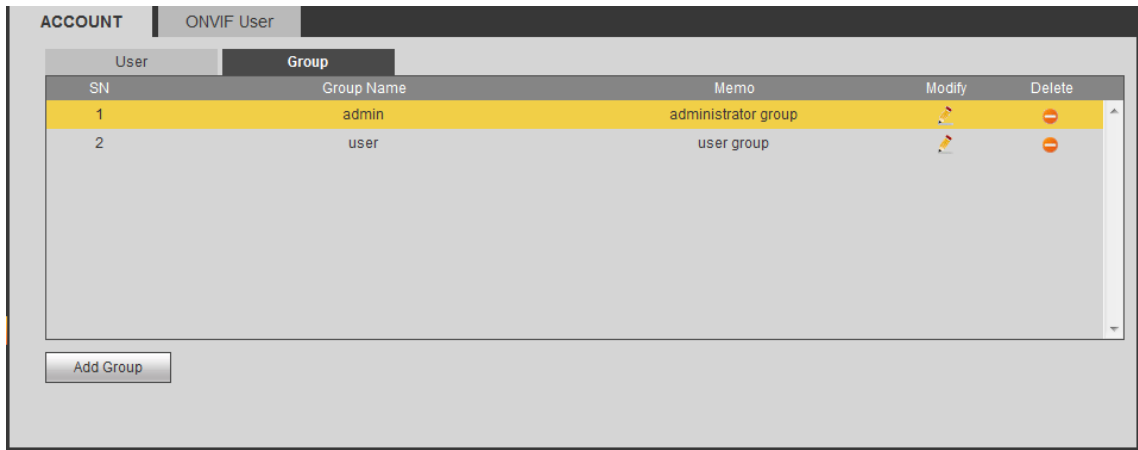

Figure 5-148

### Add group

It is to add group and set its corresponding rights.

Step 1 Click Add group button. Enter add group interface. See Figure 5-149.

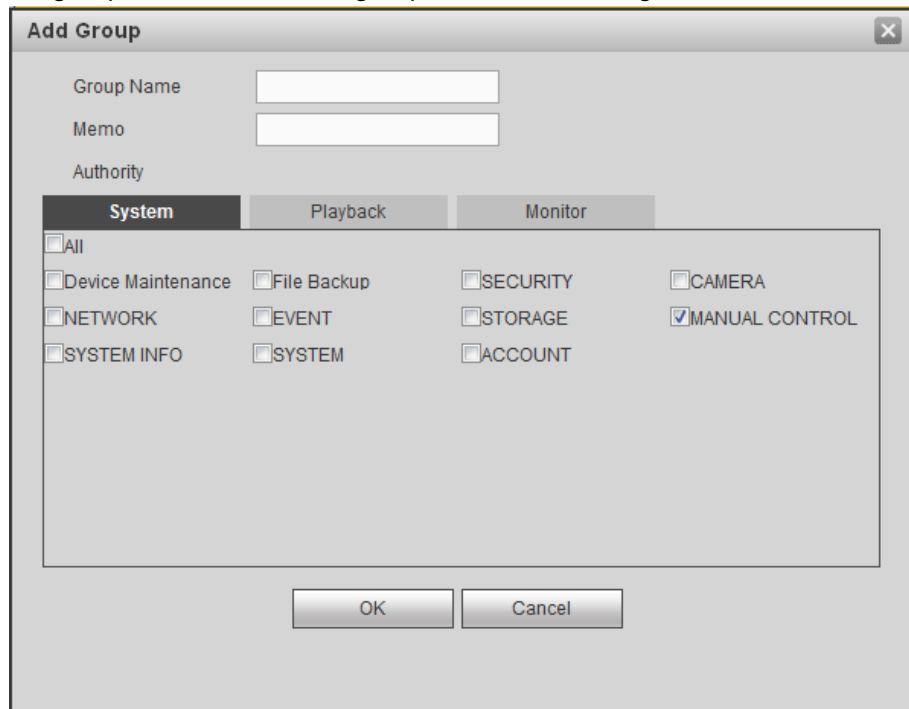

Figure 5-149

Step 2 Input the group name and then check the box to select the corresponding rights. It includes: system, playback, and monitor.

Step 3 Click Save button.

### Modify group

Step 1 Select a group and then click . See Figure 5-150.

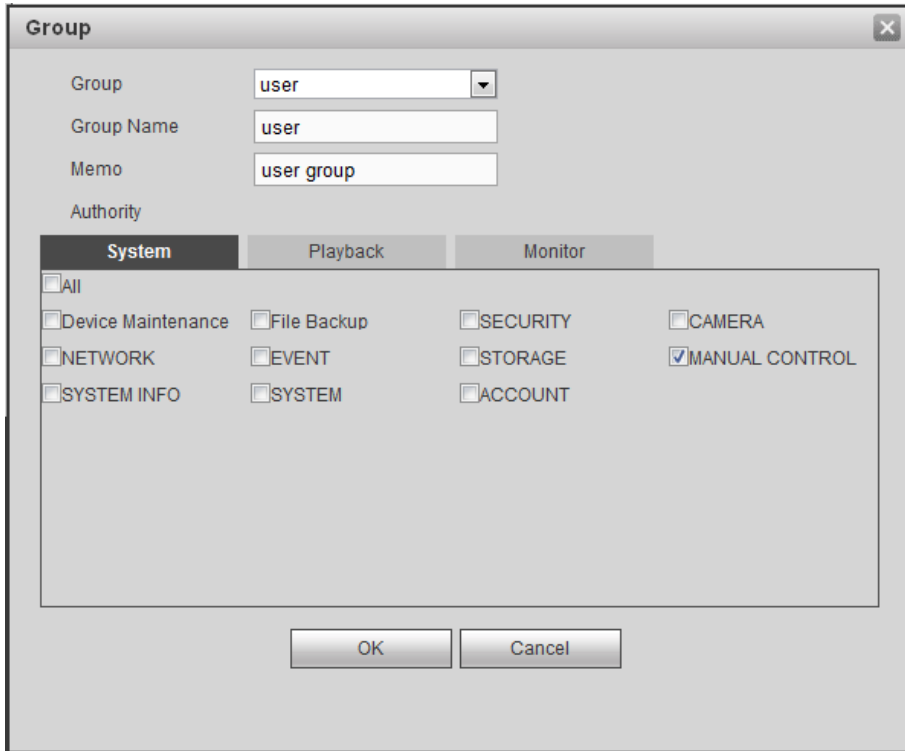

Figure 5-150

Step 2 Change corresponding information and then click Save button.

### 5.11.5.7.3 ONVIF User

When the camera from the third party is connected with the DVR via the ONVIF user, please use the verified ONVIF account to connect to the DVR.

Step 1 From main menu>Setting>System>Account>ONVIF User.

Enter ONVIF user interface. See the following figure.

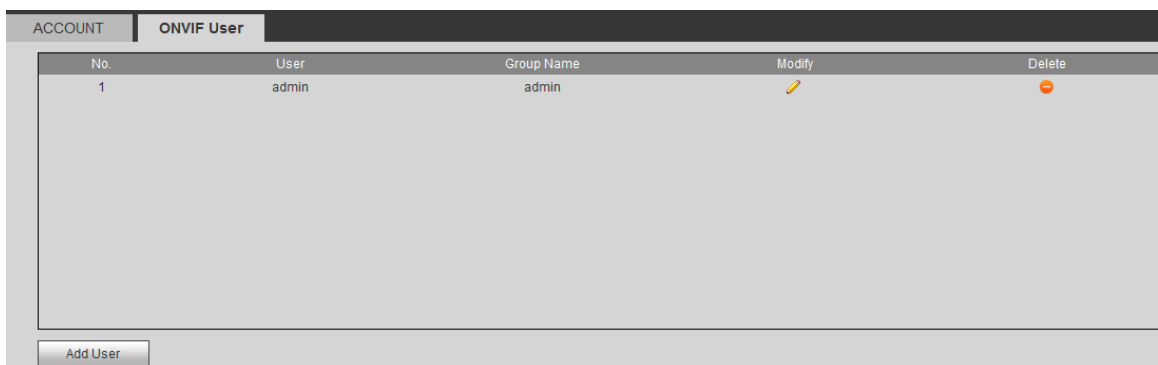

Figure 5-151

Step 2 Click Add user button.

Enter add user interface. See Figure 5-152.



The screenshot shows a dialog box titled "Add User". It has a close button (X) in the top right corner. The form contains the following elements:

- User:** A text input field.
- Password:** A text input field with three radio buttons below it labeled "Low", "Middle", and "High". The "Low" radio button is selected.
- Confirm Password:** A text input field.
- Group:** A dropdown menu currently showing "admin".
- Buttons:** "Save" and "Cancel" buttons are located at the bottom of the dialog.

Figure 5-152

- Step 3 Set user name, password and then select group from the dropdown list.
- Step 4 Click Save to complete setup.

 **Note**

Click  to change user information, click  to delete current user.

### 5.11.5.8 Security

It is to set IP filter and reset password.

#### 5.11.5.8.1 IP Filter

Set the IP host (refers to the device with an IP address) that accesses the NVR device. After the configuration is complete, only the IP host in the allowlist can successfully log in to the web interface. The IP host in the blocklist cannot log in to the web interface, thus enhancing the network and data security of the NVR device.

- Step 1 Select Setup > System > Security > IP Filter.

The IP Filter interface is displayed. See Figure 5-153.

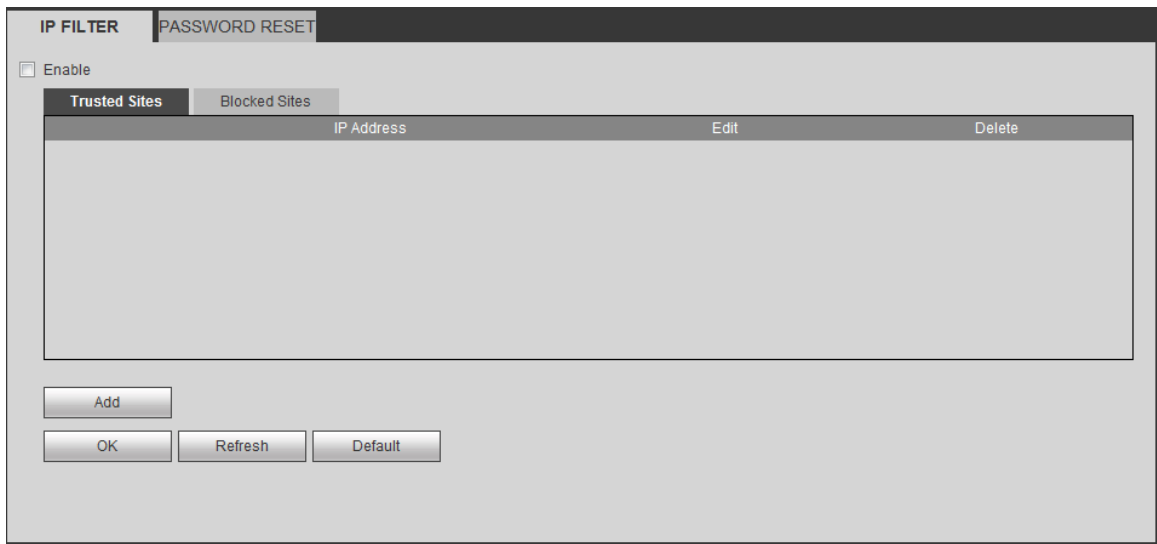

Figure 5-153

- Step 2 Select the Enable check box to enable IP filter function.
- Step 3 Add trusted sites or blocked sites.
- 1) Select Trusted Sites tab or Blocked Sites tab.
  - 2) Click Add.
- The Add interface is displayed. See Figure 5-154.

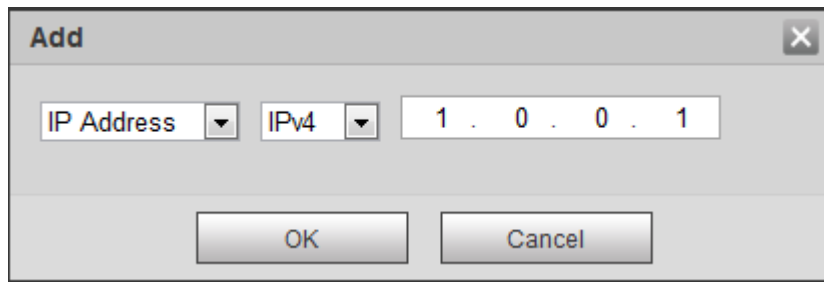



Figure 5-154

- 3) Configure the IP information. For details, see the following table.

 NOTE

The system supports to set 64 IP addresses at most.

Parameter	Description
IP Address	<p>Click the drop-down list to select the way to add trusted sites or blocked sites.</p> <ul style="list-style-type: none"> <li>● IP address: Enter the IP address you want to add to the trusted sites or blocked sites.</li> <li>● IP Segment: Enter the IP network segment range to be added to the trusted sites or blocked sites, and add multiple hosts at the same time.</li> <li>● MAC address: Enter the MAC address you want to add.</li> </ul> <p> NOTE</p> <p>The system does not support to add to blocked sites via the MAC address.</p>
IPv4	<p>Click the drop-down list to select the IP address protocol.</p> <ul style="list-style-type: none"> <li>● IPv4: Format example is 192.168.5.10.</li> <li>● IPv6: Format example is aa:aa:aa:aa:aa:aa:aa:aa.</li> </ul>

- 4) Click OK.

Step 4 Click OK to save the settings.

### 5.11.5.8.2 Password Reset



#### NOTE

- Password reset is open by default. If you forget the admin login password, click Forgot Password to reset it. For detailed operations, please refer to chapter 4.1.3 Reset Password.
- If password reset is closed, you will not be able to retrieve password by email. The only choice is to use the security questions. If security question is not set, the system directly prompts that “Password reset is closed.”

Please follow the below steps to close the password reset function.

Step 1 Select Setup > System > Security > Password Reset.

The Password Reset interface is displayed. Password reset function is enabled by default. See Figure 5-155

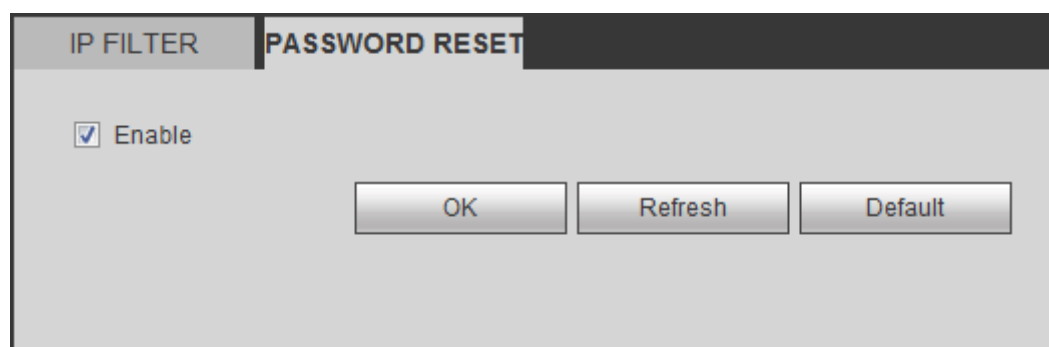

Figure 5-155

Step 2 Clear the Enable check box.

Step 3 Click OK.

System pops up a message. See Figure 5-156.

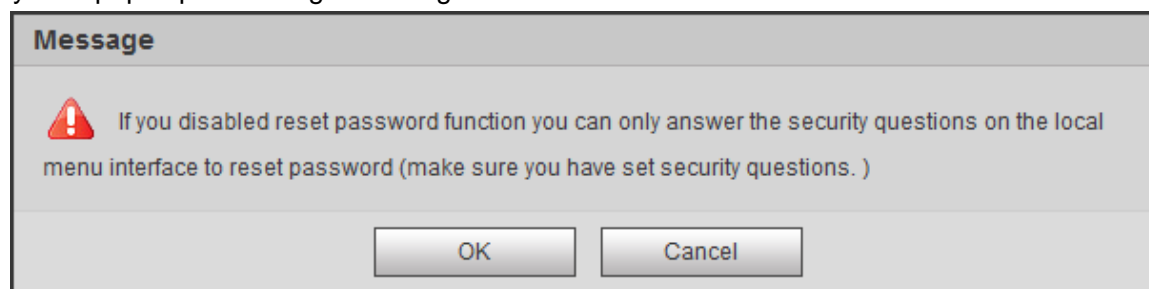

Figure 5-156

Step 4 Click OK to complete the setting.

### 5.11.5.9 Auto maintain

When the device runs for a long time, you can set the device to restart automatically during idle time to improve the device speed.

Step 1 Select Setup > System > Auto Maintenance.

The Auto Maintenance interface is displayed. See Figure 5-157.

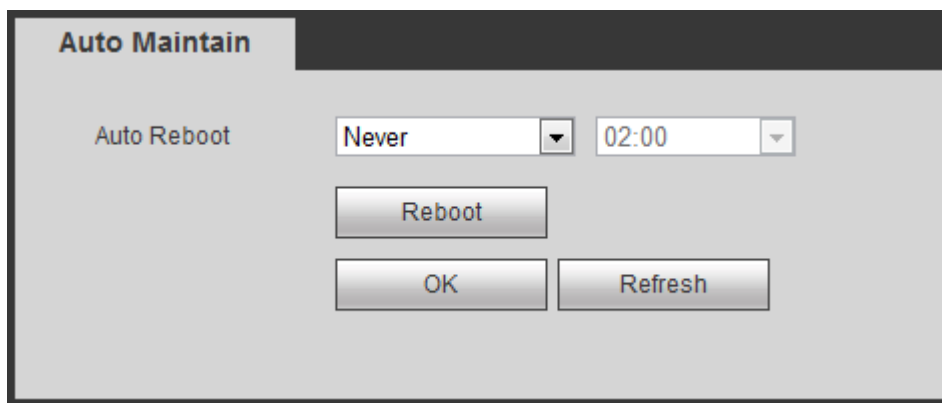

Figure 5-157

Step 2 In the Auto Reboot drop-down list, select the time to auto reboot the system.

Step 3 Click Apply or OK to complete the setting.

### 5.11.5.10 Import/Export

The interface is shown as in Figure 5-158. This interface is for you to export or import the configuration files.

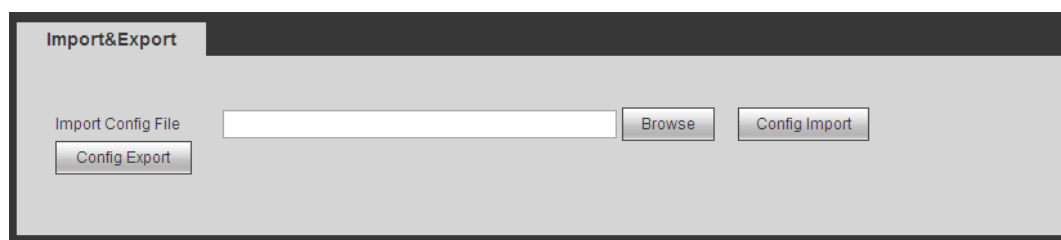

Figure 5-158

Please refer to the following sheet for detailed information.

Parameter	Function
Browse	Click to select import file.
Import	It is to import the local setup files to the system.
Export	It is to export the corresponding WEB setup to your local PC.

### 5.11.5.11 Default

The default setup interface is shown as in Figure 5-159.

Here you can select Network/Event/Storage/Setting/Camera. Or you can check the All box to select all items.

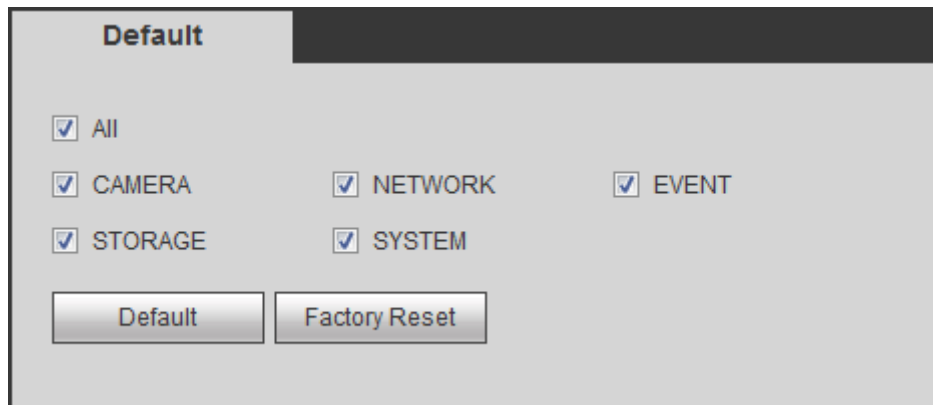

Figure 5-159

## 5.11.5.12 Upgrade

### 5.11.5.12.1 File Upgrade

Insert the USB device with the upgrade file into the NVR device and then you can upgrade the system version of the NVR device.

Step 1 Select Setup > System > Upgrade.

The Upgrade interface is displayed. See Figure 5-160.



Figure 5-160

Step 2 Insert the USB device and click Upgrade.

The Upgrade interface is displayed.

Step 3 Select the upgrade file and click Start.

After the upgrade is completed, the system prompts Completed.

### 5.11.5.12.2 Cloud Upgrade

When the NVR is online, you can use the online upgrade to update the firmware.



#### Note

Make sure the NVR has properly connected to the network.

## Version Detection



The version detection includes auto detection and manual detection. It displays current system version and application released date.

- Enable auto detection, NVR interactive with the cloud to detect there is new version available or not.
- Click manual detection, it is to view the latest new version on the cloud.
  - ✧ If current version is the latest one, there is prompt “It is the latest version”.
  - ✧ If NVR detects there is new version available, system displays new version information such as released date and corresponding release note.

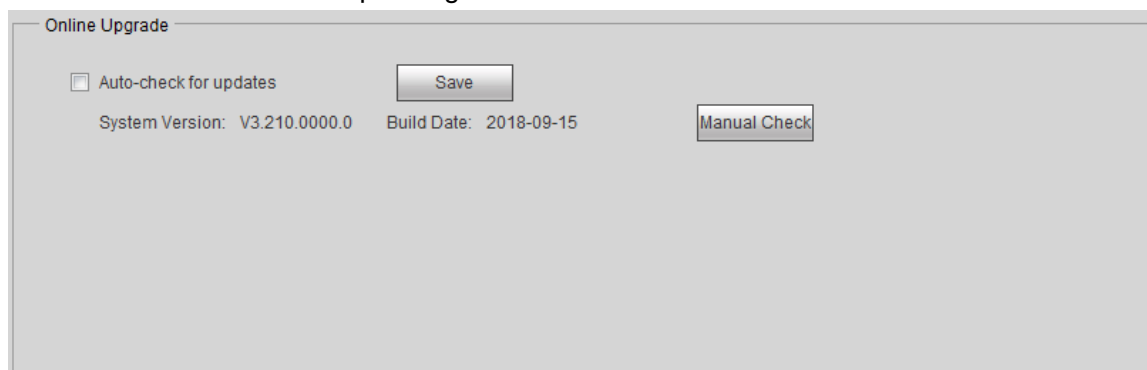

Figure 5-161

## Upgrade System



### CAUTION

During the upgrade process, make sure the network connection and power supplying are both OK.

Click Start to upgrade system.

## 5.12 Information

### 5.12.1 Version

You can view the hardware features, software version and release date of the NVR device system.

Select Info > Info > Version. The Version interface is displayed.



#### NOTE

The system displays different version information for different models. See the actual interface.

When the system finds a new version, the interface displays Found New Version. See Figure 5-162.

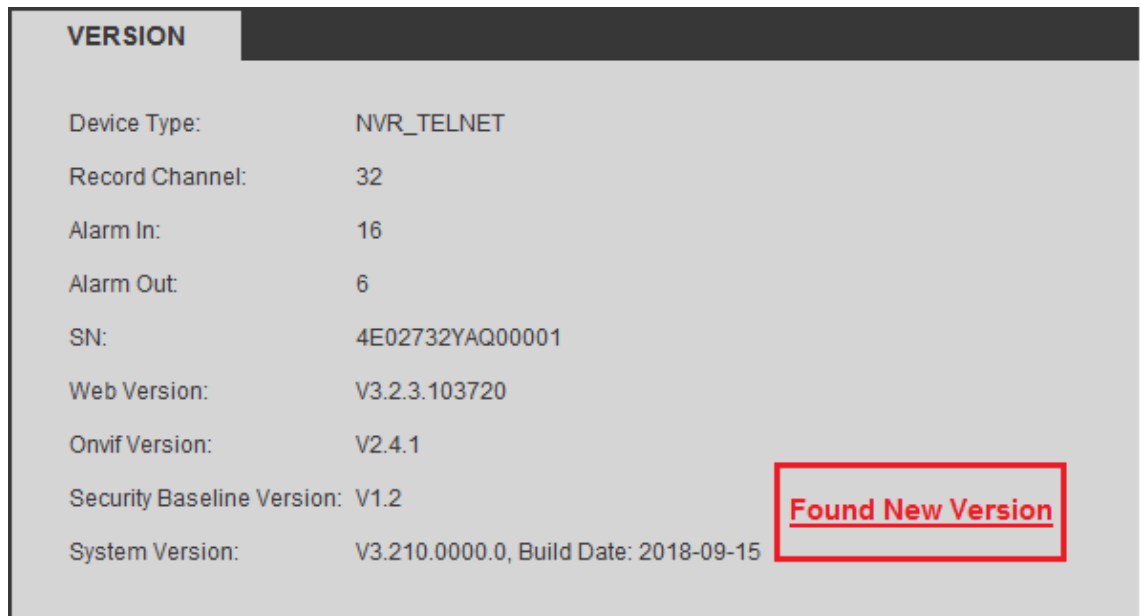

Figure 5-162

Click Found New Version and the system automatically switches to the Upgrade interface.

## 5.12.2 Log

Here you can view system log. See Figure 5-163.

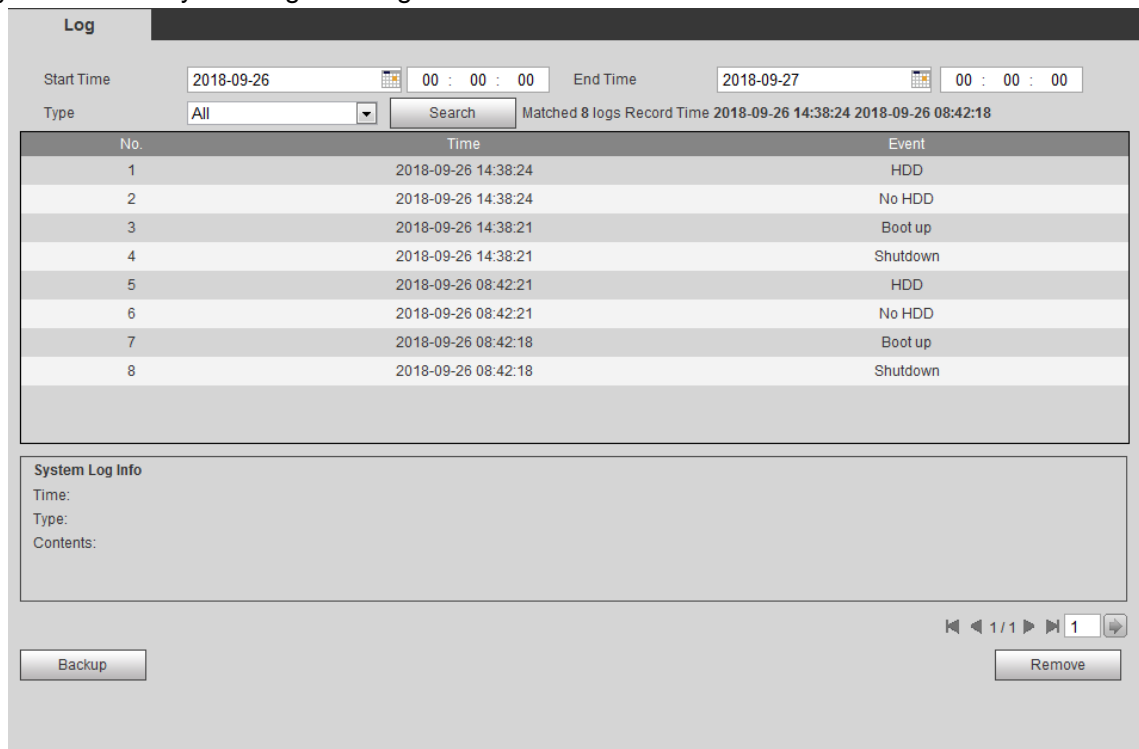

Figure 5-163

Please refer to the following sheet for log parameter information.

Parameter	Function
Type	Log types include: system operation, configuration operation, data operation, event operation, record operation, user management, log clear.
Start time	Set the start time of the requested log.
End time	Set the end time of the requested log.
Search	You can select log type from the drop down list and then click search button to view the list. You can click the stop button to terminate current search operation.
Detailed information	You can select one item to view the detailed information.
Clear	You can click this button to delete all displayed log files. Please note system does not support clear by type.
Backup	You can click this button to backup log files to current PC.

### 5.12.3 Online User

The online user interface is shown as in Figure 5-164.

No.	User Name	Group Name	IP Address	User Login Time
1	admin	admin	10.15.9.152	2013-10-24 04:31:33 PM
2	admin	admin	10.15.9.152	2013-10-24 04:21:12 PM
3	admin	admin	10.15.6.145	2013-10-24 04:50:01 PM

Refresh

Figure 5-164

### 5.12.4 People Counting

Select Info > Info > People counting, the interface is shown as in Figure 5-165.

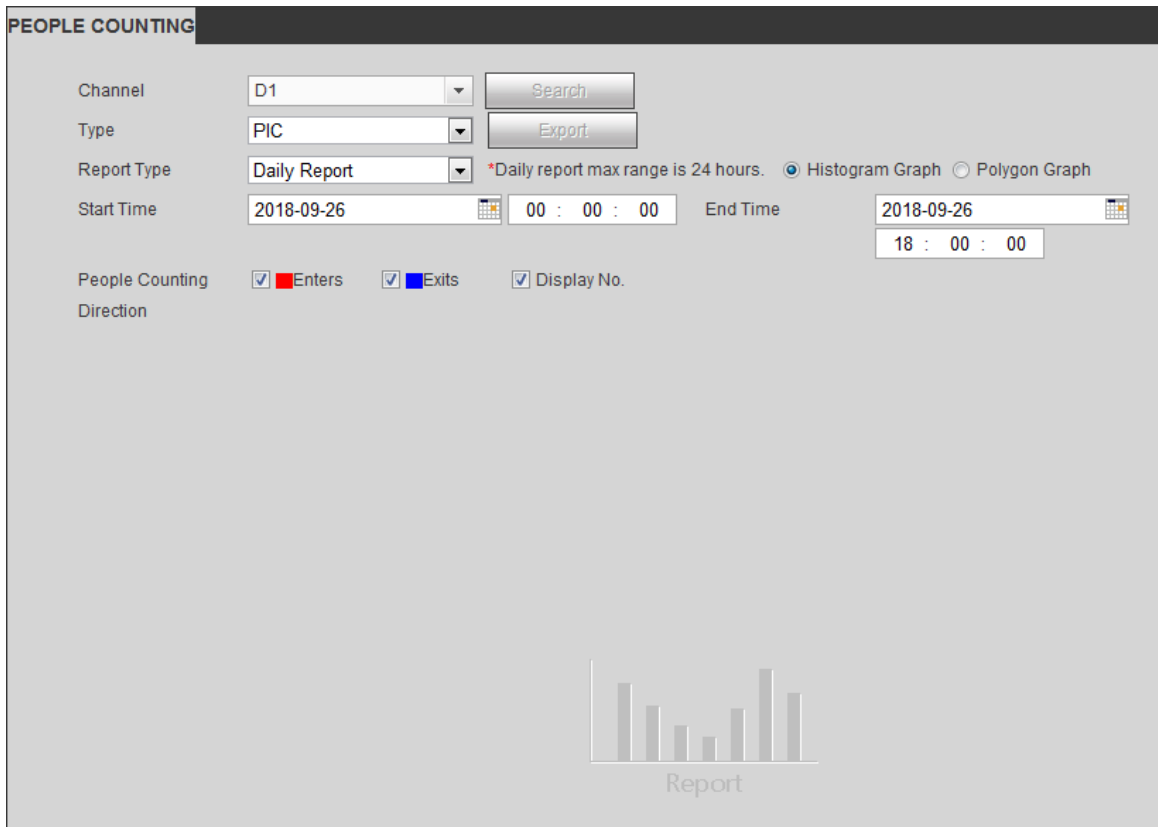

Figure 5-165

## 5.12.5 Heat Map

Select Info > Info > Heat Map, the interface is shown as in Figure 5-166.

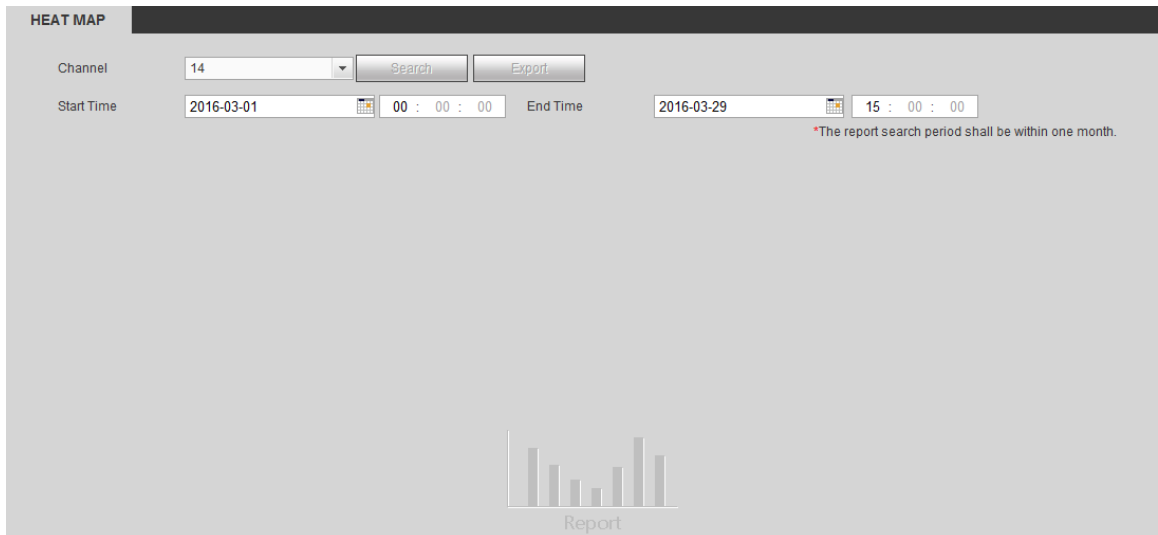

Figure 5-166

## 5.12.6 HDD

Select Info > Info > HDD, the HDD interface is shown as in Figure 5-167. Here you can view HDD information.

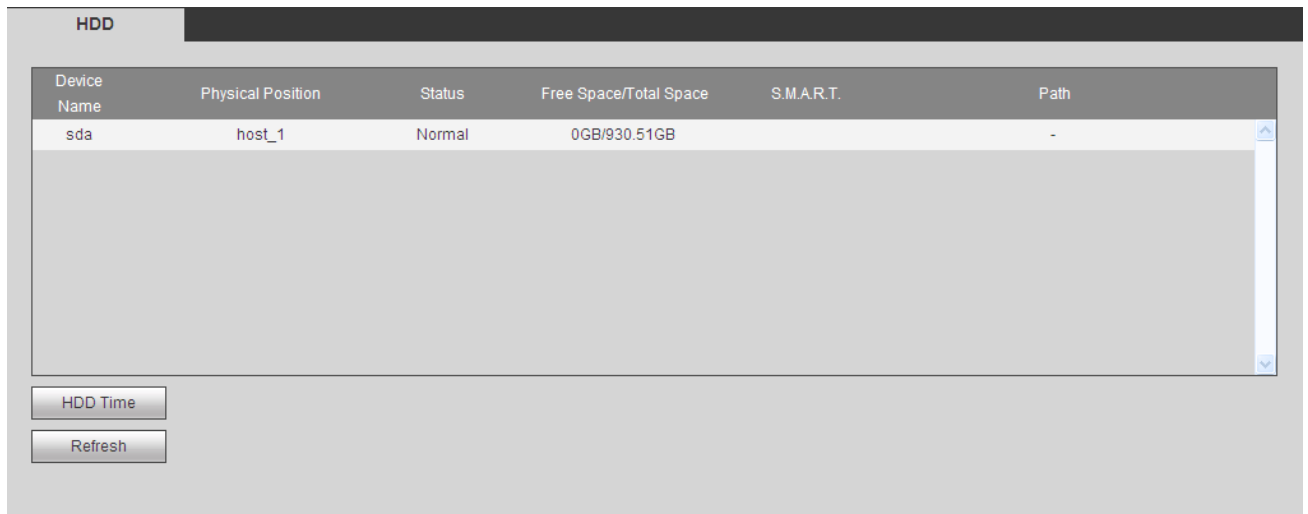

Figure 5-167

## 5.13 Playback

Click Playback button, you can see an interface is shown as in Figure 5-168.

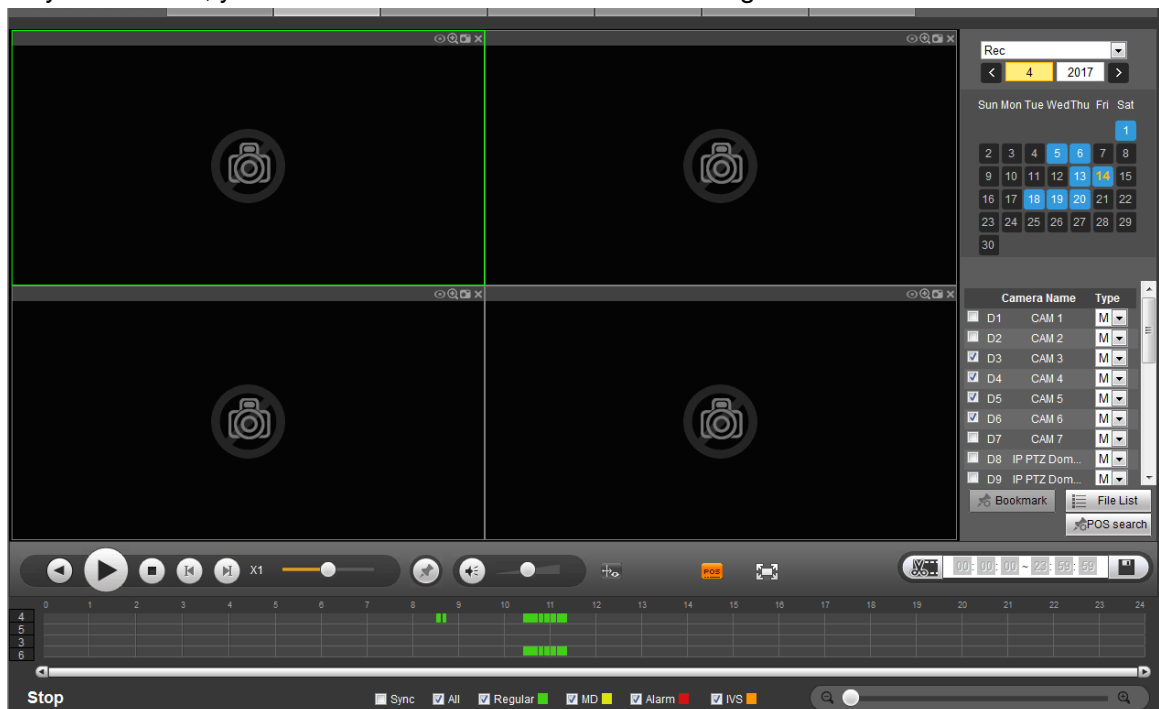

Figure 5-168

## 5.13.1 Search Record

Please set record type, record date, window display mode and channel name.

- Select Date

You can click the date on the right pane to select the date. The green highlighted date is system current date and the blue highlighted date means it has record files.

- Window Split

Select window split mode. Click  to display in full screen. Click ESC button to exit. See Figure 5-169.



Figure 5-169

- Select Channel

1–4 means main stream and A1–A4 means sub stream.

- Select Record Type

Check the corresponding box to select record type. See Figure 5-170.



Figure 5-170

## 5.13.2 File List

Click File list button, you can see the corresponding files in the list. See Figure 5-171.

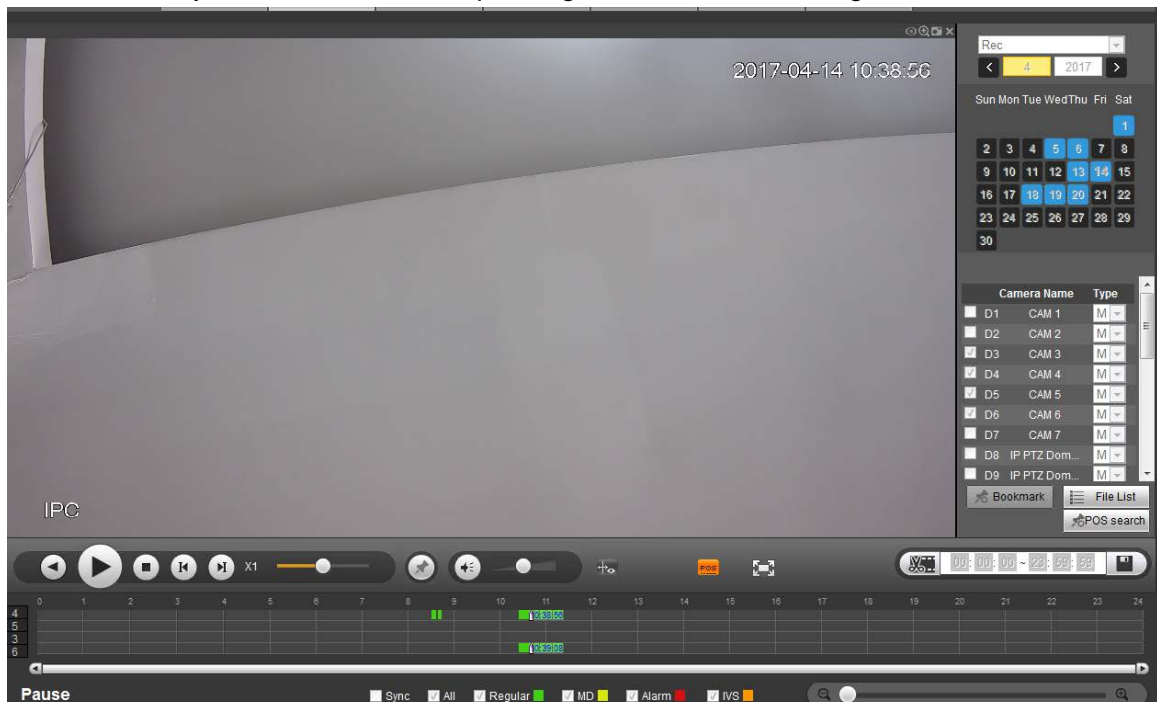

Figure 5-171

### 5.13.3 Playback

Select a file you want to play and then click Play button, system can begin playback. You can select to playback in full-screen. Please note for one channel, system cannot playback and download at the same time. You can use the playback control bar to implement various operations such as play, pause, stop, slow play, fast play and etc. See Figure 5-172.

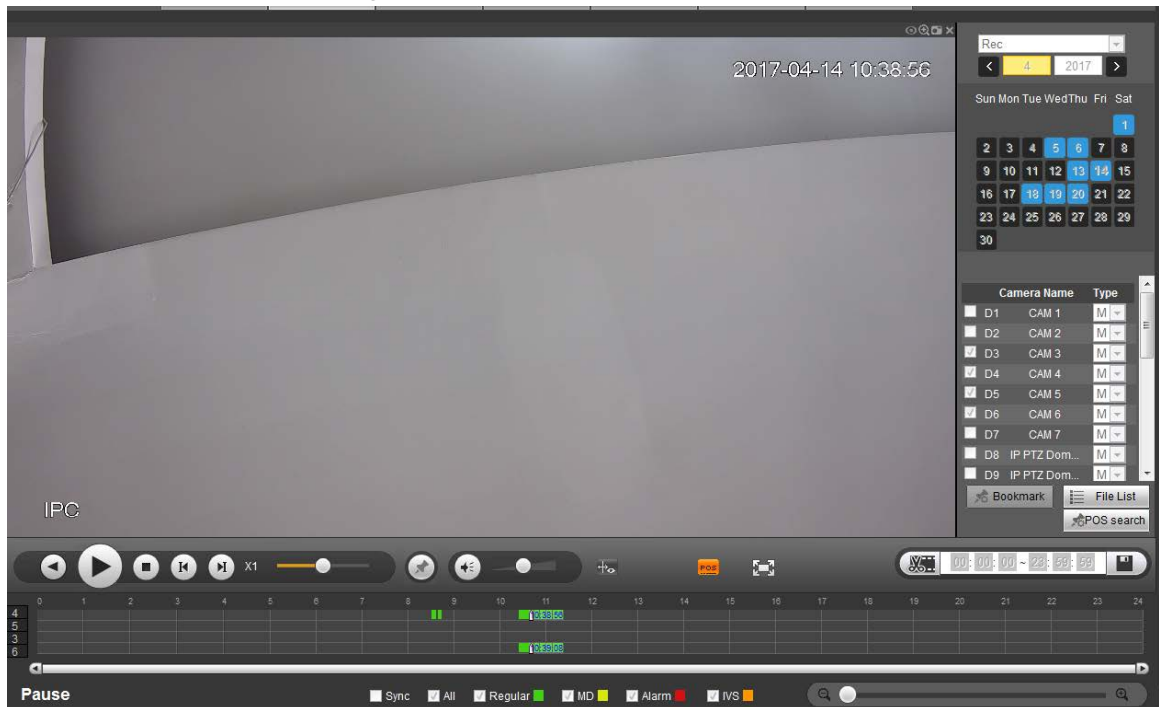

Figure 5-172

### 5.13.4 Download

Select the file(s) you want to download and then click download button, you can see an interface shown as in Figure 5-173. The Download button becomes Stop button and there is a process bar for your reference. Please go to you default file saved path to view the files.



Figure 5-173

## 5.13.5 Load more

It is for you to search record or picture. You can select record channel, record type and record time to download. Or you can use watermark function to verify file.

### 5.13.5.1 Download By File

Select channel, record type, bit stream type and then input start time and end time. Click Search button, the download by file interface is shown as in Figure 5-174.

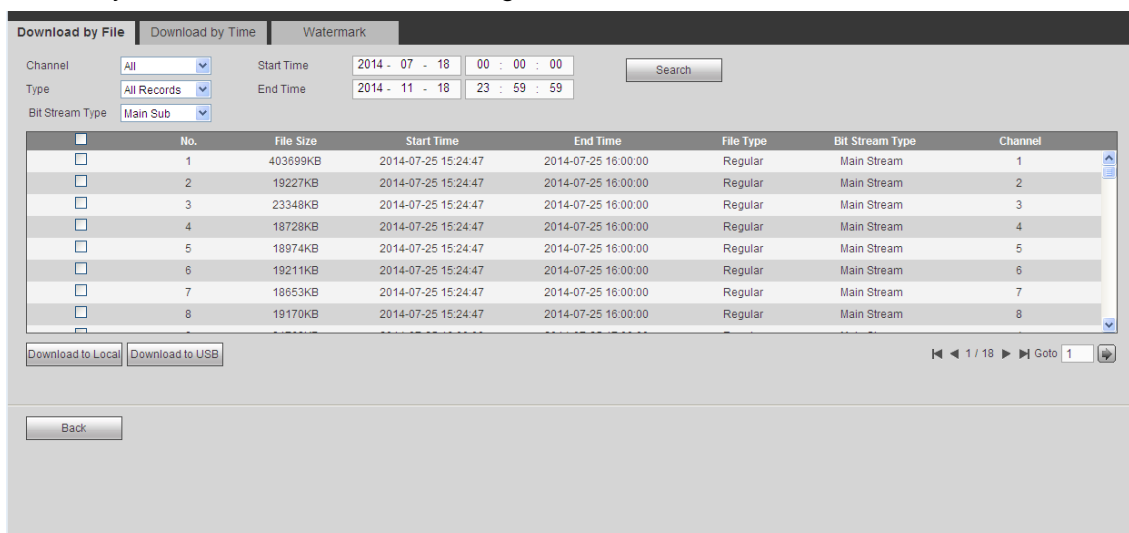

Figure 5-174



Check the file(s) you want to download and there are two options for you to save the file(s).

- Download to local

Click Download to local, system pops up the following interface for you to set record format and saved path. See Figure 5-175.

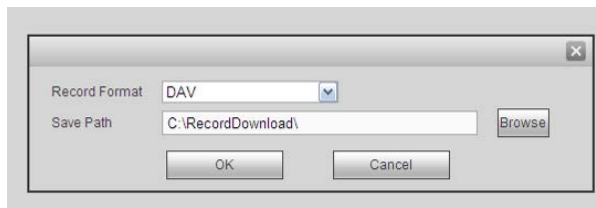

Figure 5-175

You can click OK to download and view the download process. After the download operation, you can see corresponding dialog box.

- Download to USB

Connect the corresponding peripheral device, and then click Download to USB button, you can see the following interface. See Figure 5-176.

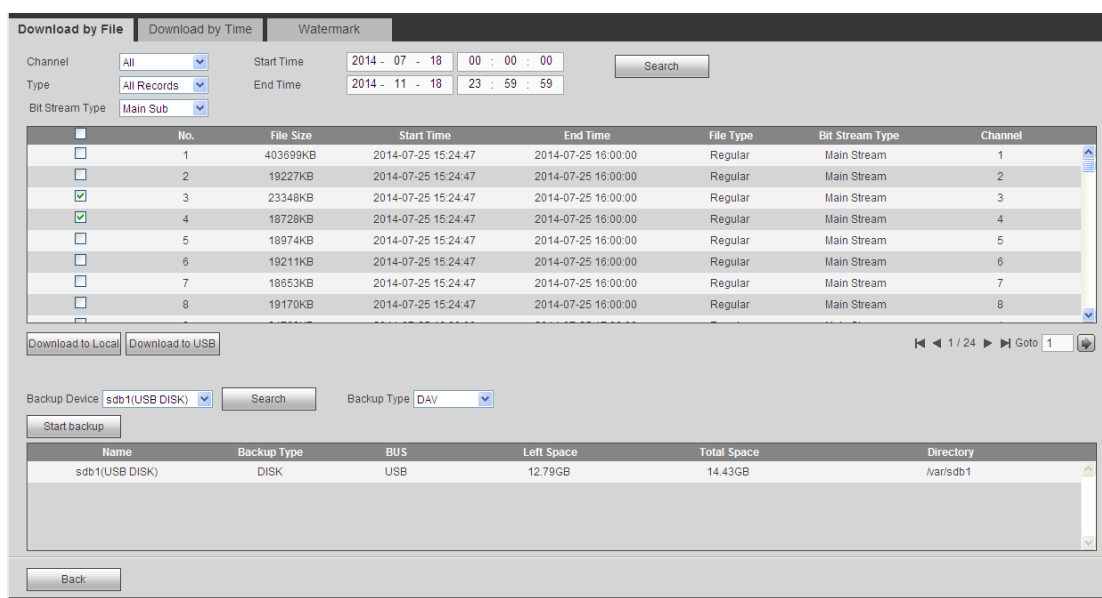

Figure 5-176

Select Backup device and backup type first and then click Start backup button. After the download operation, you can see corresponding dialogue box.

### 5.13.5.2 Download by Time

Select channel, bit stream type, start time and end time.

Click Download to Local button, you can see download by time interface is shown as in Figure 5-177.

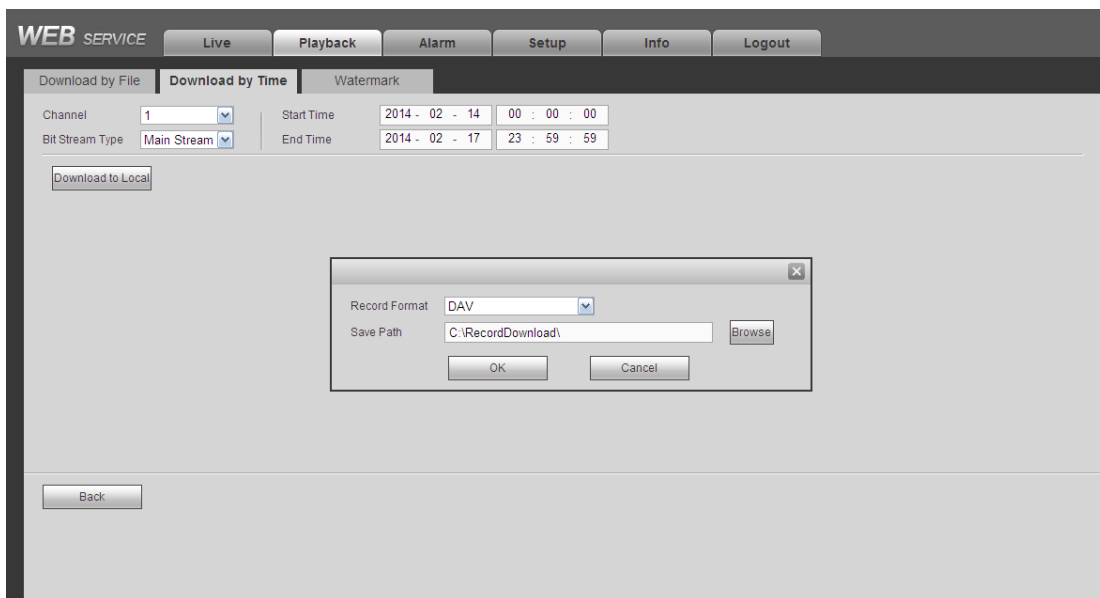

Figure 5-177

Set record format and saved path, you can click OK to download and view the download process. After the download operation, you can see corresponding dialog box.

### 5.13.5.3 Watermark

Watermark interface is shown as In Figure 5-178. Please select a file and then click Verify button to see the file has been tampered with or not

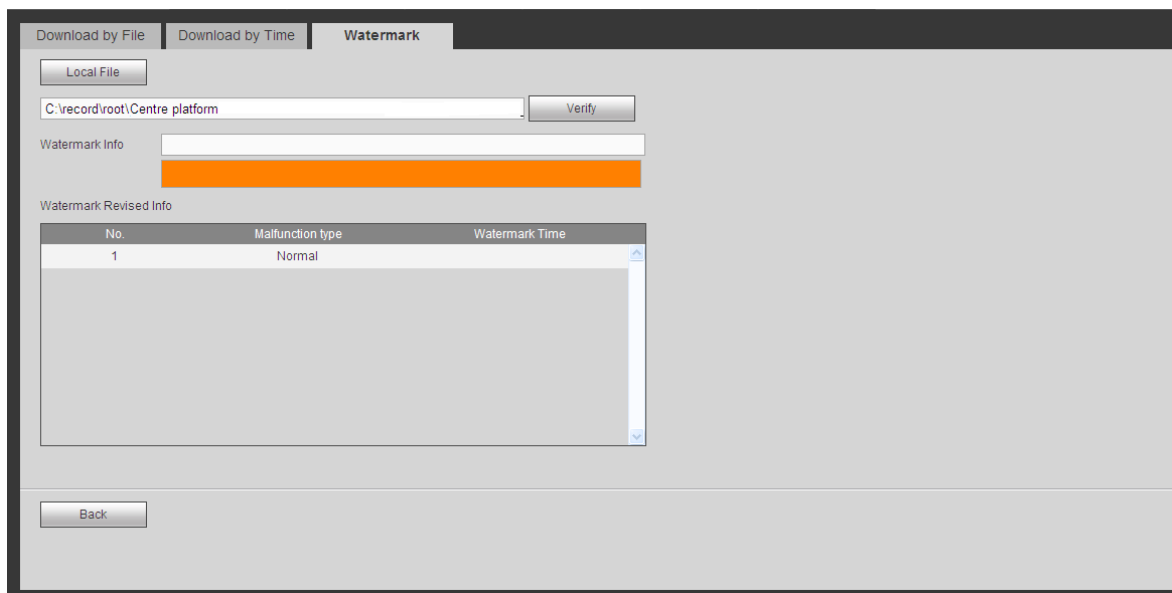

Figure 5-178

## 5.14 Smart Search

It is to analyze the records stored in the device and screen out the files meeting the detection rule to facilitate record playback by users.

Click Smart Search tab and Smart Search interface is displayed. See Figure 5-179.



NOTE

AI by camera: A specified IPC such as smartIPC which supports smart analysis by itself. The NVR device only needs to detect and display the smart alarm info from the IPC, and performs the smart analysis configuration and record playback for the IPC.

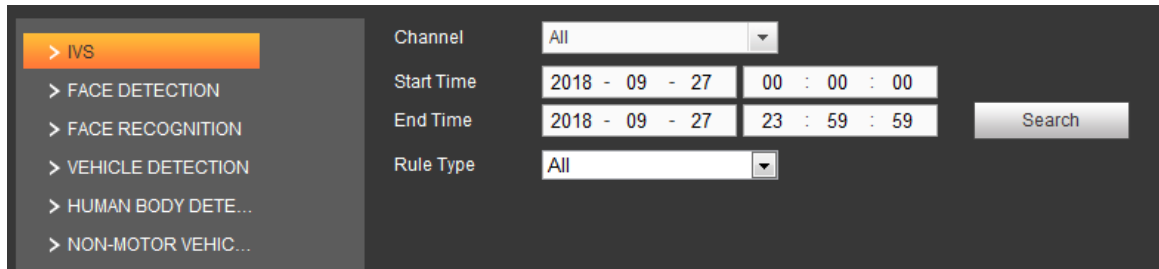

Figure 5-179

### 5.14.1 IVS

IVS extracts the key information in video based on image processing and analysis, and matches it with the preset detection rules. You can screen out and play the videos matching the rules.

Step1 Select Smart Search > IVS.

The IVS interface is displayed. See Figure 5-180.

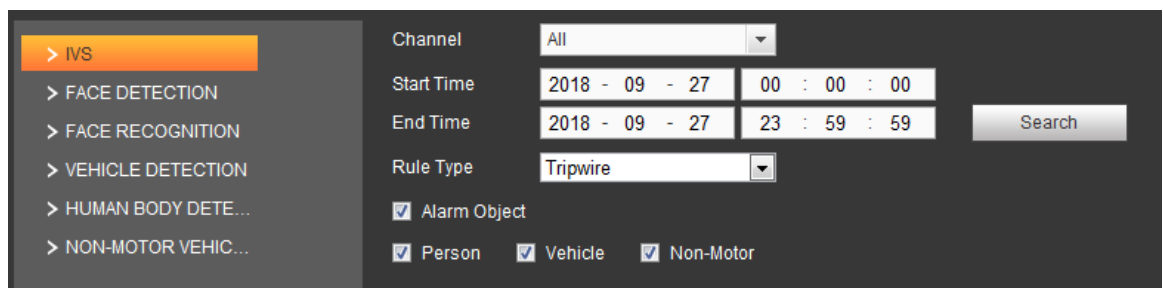

Figure 5-180

Step2 Select the Channel and enter the Start Time and End Time.

Step3 Click Search.

The pictures meeting the conditions are displayed. See Figure 5-181.

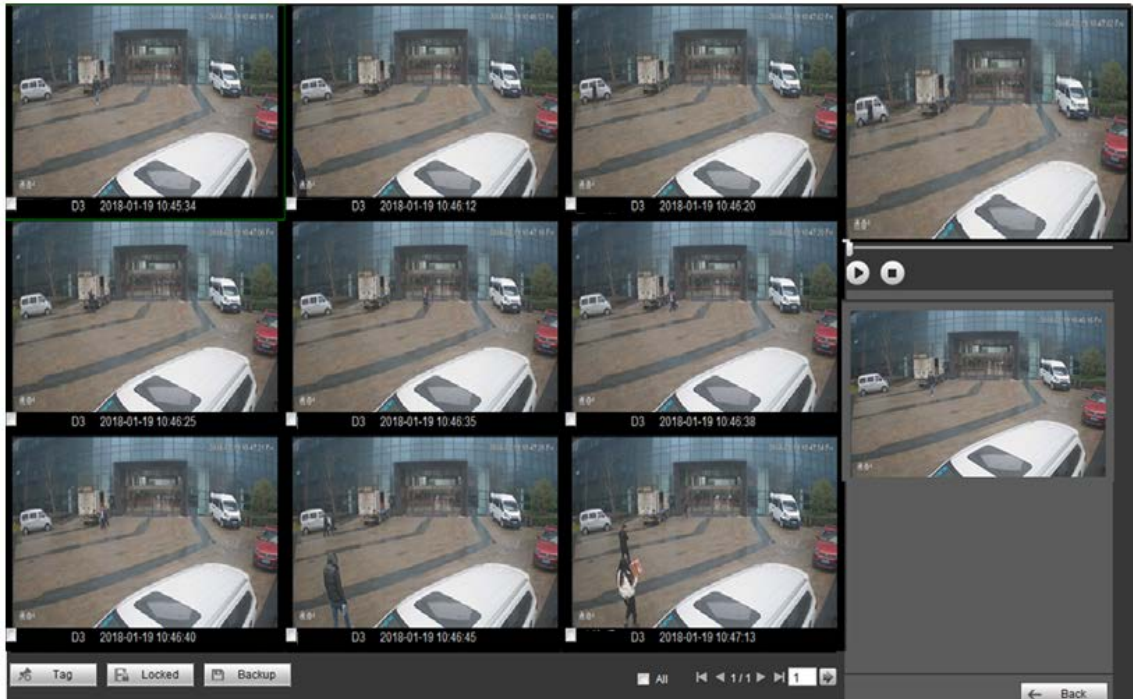





Figure 5-181

 NOTE

Click Delete on the main interface of Smart Search to clear the rule type, channel, start time and end time.

Step4 Click the image and you can view the record file.

- Select a file and click  Backup . You can save the current file to peripheral storage devices.
- Select a file and click  Locked . You can lock current file in case it will be overwritten.
- Select a file and click  Tag . You can mark the time of the detected event.

## 5.14.2 Face Detection

Human face detection is to analyze the video from the camera and check if there is any human face. It is to search and playback human face record.

Step1 Select Smart Search > Face Detection.

The Face Detection interface is displayed. See Figure 5-182.

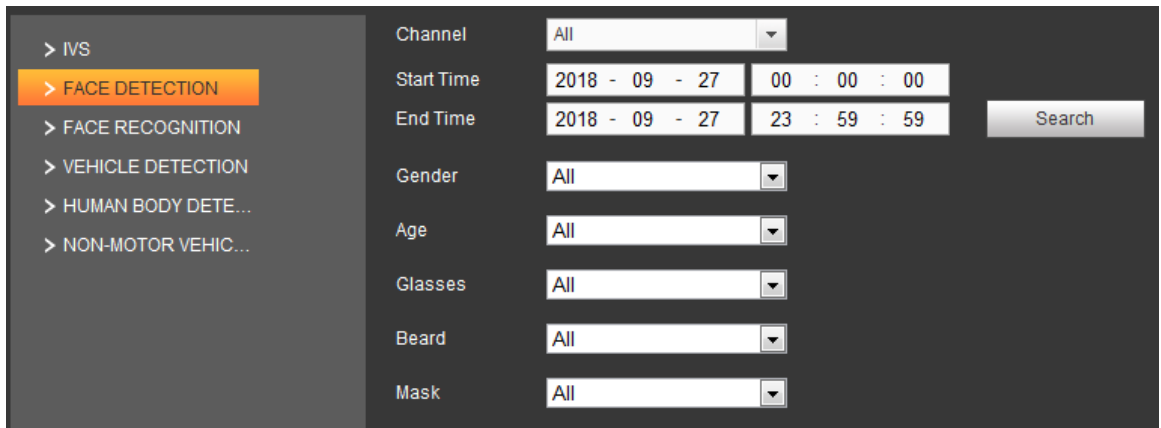

Figure 5-182

Step2 Select Channel, Start Time and End Time and set the filter conditions.

Step3 Click Search.

The images meeting the conditions are displayed. See Figure 5-183.



 NOTE

The following human faces are modified for privacy protection. The actual images have high definition.



Figure 5-183

Step4 Click the image and you can view the record file.

- Select a file and click  Backup . You can save the current file to peripheral storage devices.
- Select a file and click  Locked . You can lock current file in case it will be overwritten.
- Select a file and click  Tag . You can mark the time of the detected event.

## 5.14.3 Face Recognition

System supports to detect and compare the faces in the video with those in the database and play back the records. Smart detection includes searching by attribute and searching by image.

 NOTE

Only some devices support this function.

### 5.14.3.1 Searching by Attribute

Step1 Select Smart Search > Face Recognition.

The Face Recognition interface is displayed. See Figure 5-184.

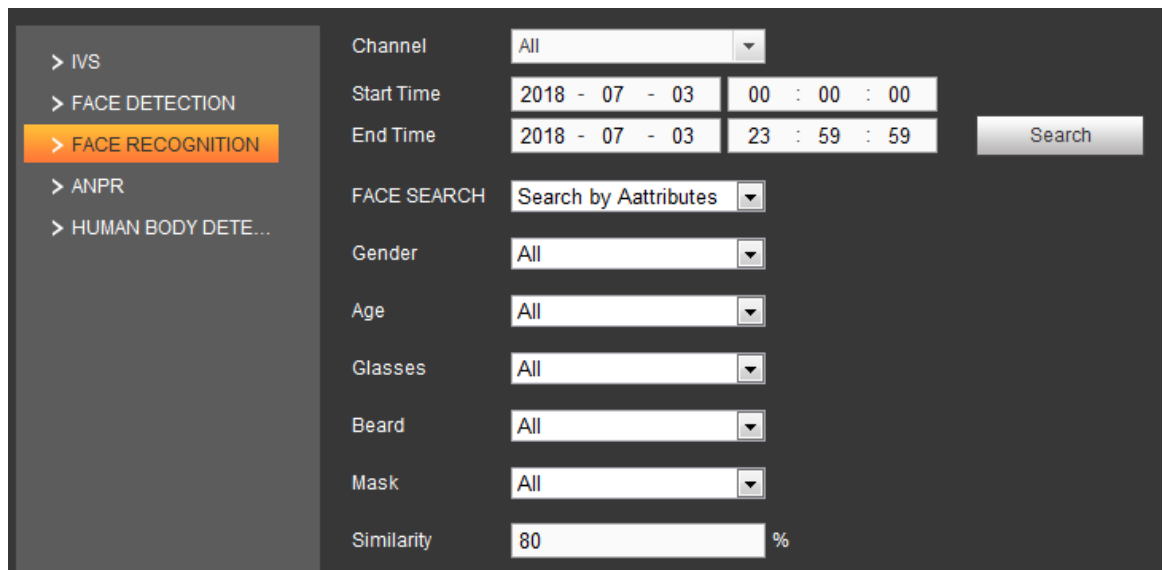

The screenshot shows a web interface for face recognition. On the left is a navigation menu with options: > IVS, > FACE DETECTION, > FACE RECOGNITION (highlighted in orange), > ANPR, and > HUMAN BODY DETE... The main area contains search filters: Channel (All), Start Time (2018 - 07 - 03 00 : 00 : 00), End Time (2018 - 07 - 03 23 : 59 : 59), FACE SEARCH (Search by Aattributes), Gender (All), Age (All), Glasses (All), Beard (All), Mask (All), and Similarity (80 %). A Search button is located to the right of the time fields.

Figure 5-184

Step2 Select Channel and enter Start Time and End Time.

Step3 In the Face Search drop-down list, select Search by Attributes.

Step4 Configure the other filter conditions.

Step5 Click Search.

The images meeting the conditions are displayed. See Figure 5-185.

 NOTE

The following human faces are modified for privacy protection. The actual images have high definition.

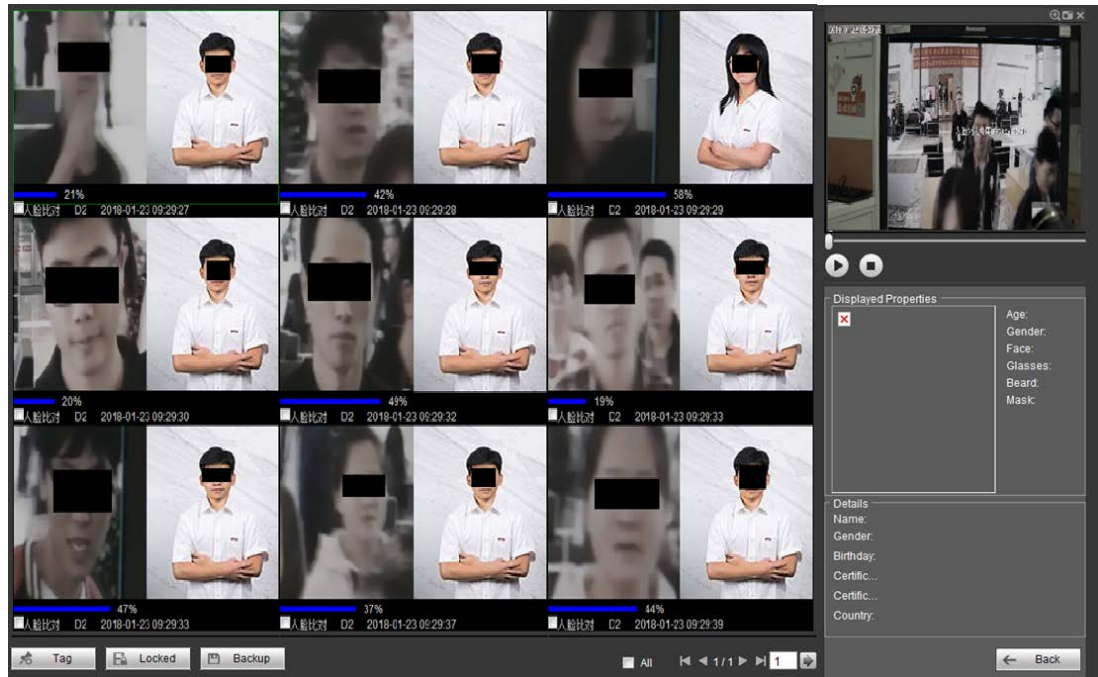
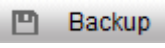
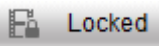



Figure 5-185

Step6 Click the image and you can view the record file.

- Select a file and then click  Backup, you can save current file to peripheral storage devices.
- Select a file and then click  Locked, you can lock current file in case it will be overwritten in the future
- Select a file and then click  Tag, you can mark the time of the detected event.

### 5.14.3.2 Searching by Image

Step1 Select Smart Search > Face Recognition.

Step2 Select the Channel and enter the Start Time and End Time.

Step3 In the Face Search drop-down list, select Search by Image. Enter the Similarity.

The interface is shown as follows. See Figure 5-186.

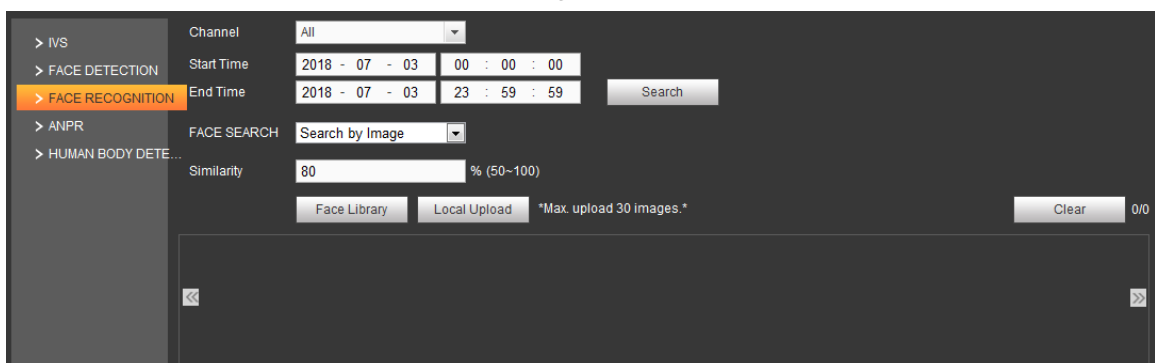

Figure 5-186

Step4 Upload image. The system supports two ways: Face library and local upload.

- Face Library Upload

1. Click Face Library.

The Face Library interface is displayed. See Figure 5-187.

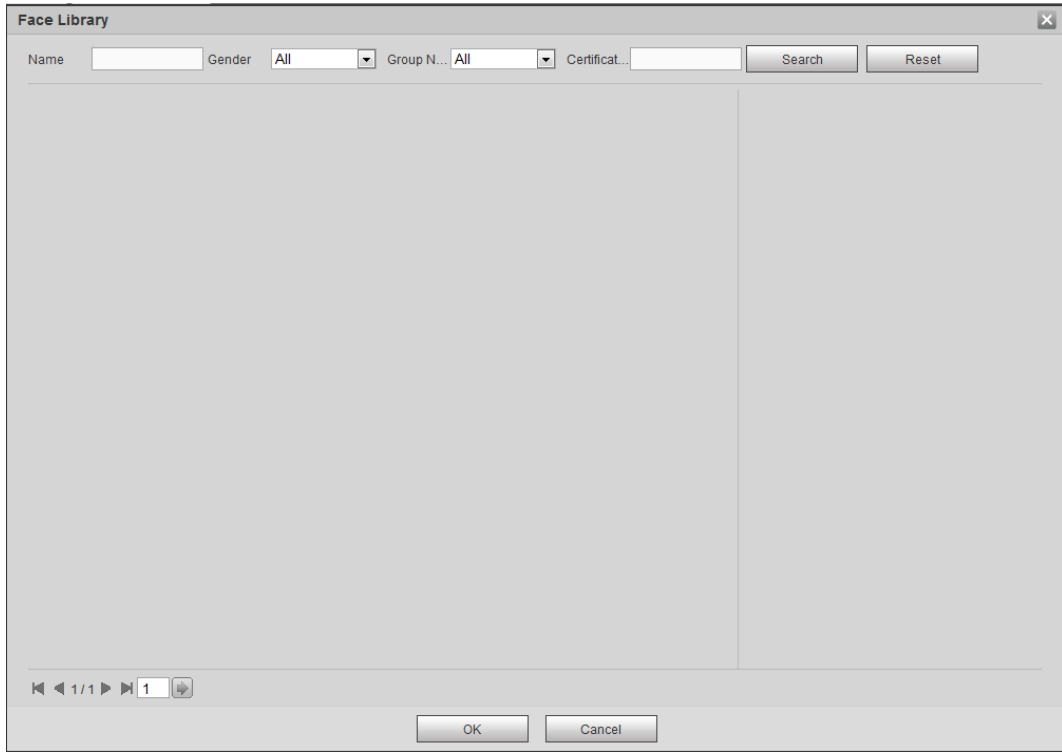

Figure 5-187

2. Configure the parameters, such as name, gender, group name and certificate number.
3. Click Search and the results are displayed. See Figure 5-188.

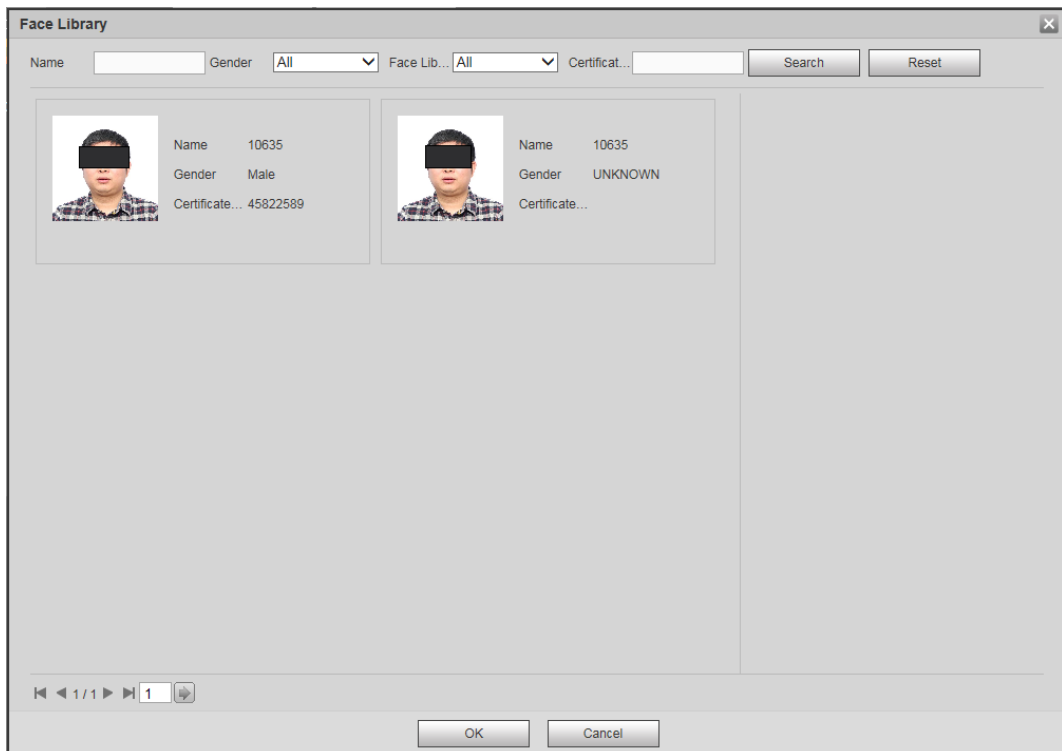



Figure 5-188

4. Select the image and click OK.

The system returns to the search by image interface. See Figure 5-189.

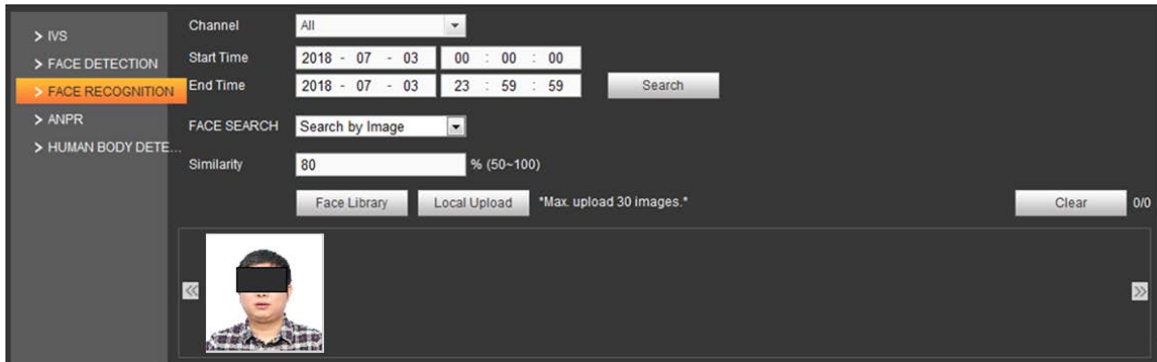

Figure 5-189

- Local Upload

Click Local Upload, select the image and click OK to upload the image.

NOTE

You can upload max 30 images at one time.

Step5 After the image is uploaded successfully, click Search.

The results are displayed. See Figure 5-190.

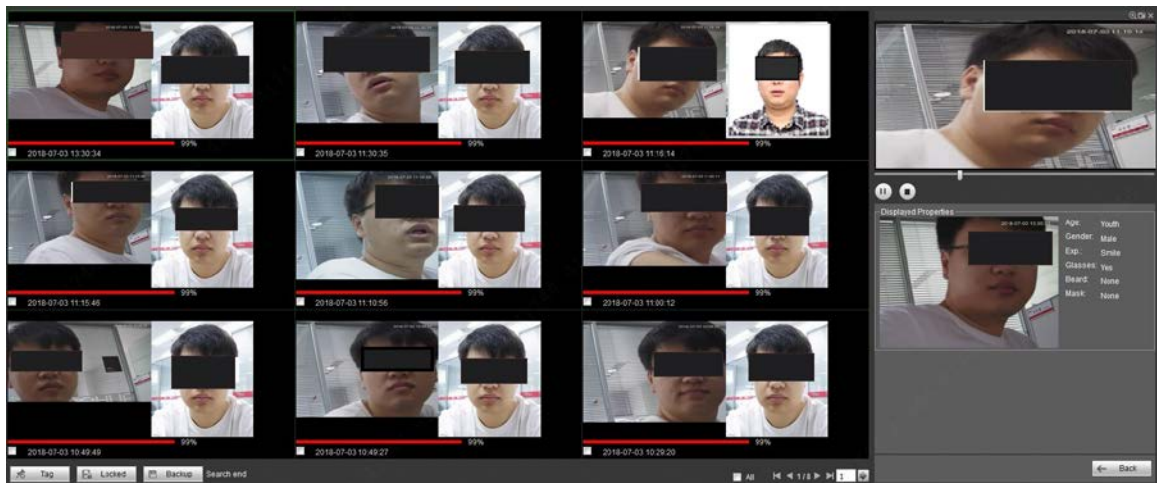

Figure 5-190

## 5.14.4 Vehicle Detection

The license plate recognition adopts video image recognition technology to extract the license plate number in the video image and match with the preset license plate number. You can filter out the video of a particular license plate or videos of all the license plates and play back the records.

NOTE

Only some devices support this function.

Step1 Select Smart Search > Vehicle Detection.

The Vehicle Detection interface is displayed. See Figure 5-191.

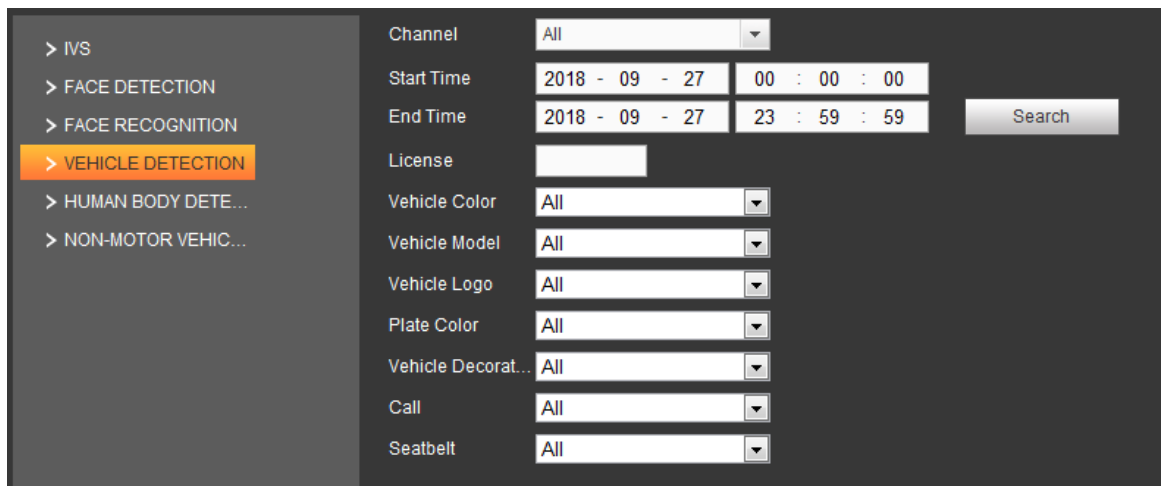

Figure 5-191

Step2 Select Channel and configure other parameters.

 NOTE

- The system supports plate fuzzy search.
- All plates will be searched by default if the license number is not set.

Step3 Click Search.

The images meeting the conditions are displayed. See Figure 5-192.



Figure 5-192

Step4 Click the image and you can view the record file.

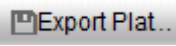
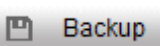
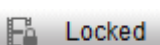
- Click  to export the plate information to local PC.
- Select a file and click . You can save current file to peripheral storage devices.
- Select a file and click . You can lock current file in case it will be overwritten.

- Select a file and click  Tag. You can mark the time of the detected event.

## 5.14.5 Human Body Detection

The system analyzes the video images captured by the camera and detects if any human body exists. You can screen out and play the videos with human body.

Step1 Select Smart Search > Human Body Detection.

The Human Body Detection interface is displayed. See Figure 5-193.

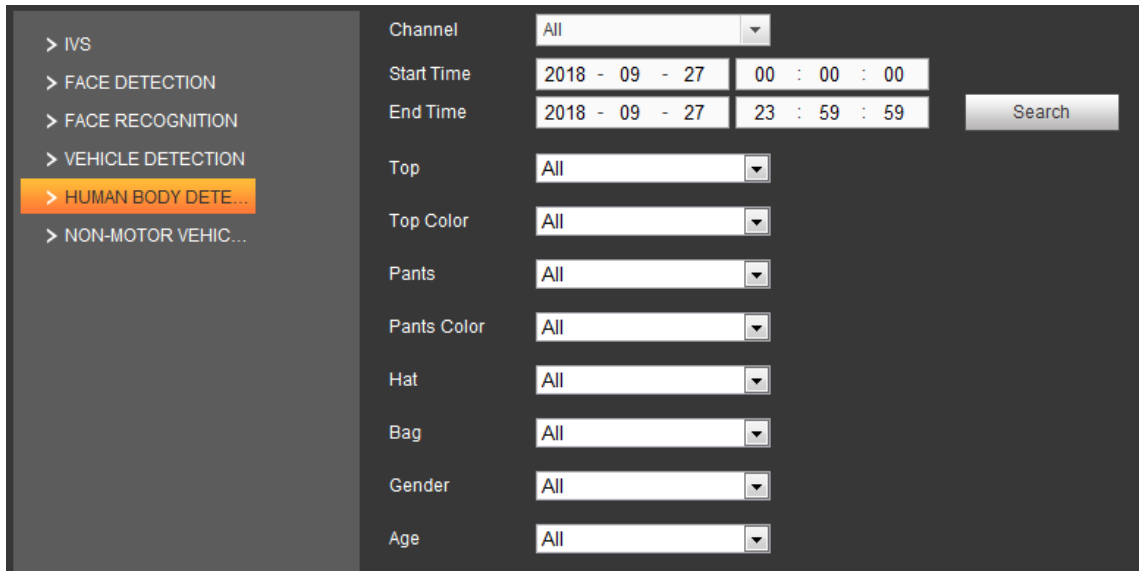

Figure 5-193

Step2 Select Channel, enter Start Time and End Time, and configure the other filter conditions.

Step3 Click Search.

The images meeting the conditions are displayed. See Figure 5-194.

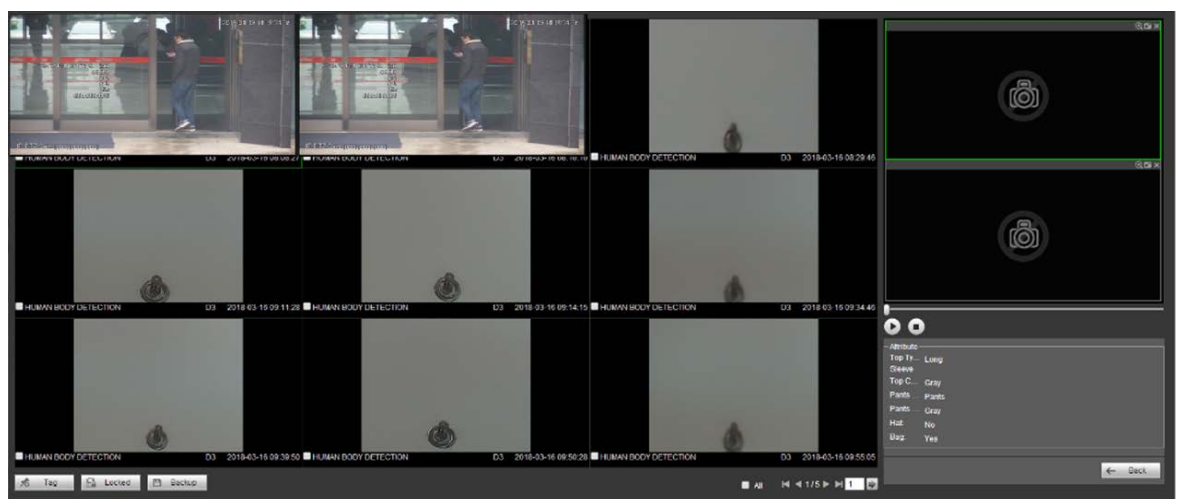





Figure 5-194

Step4 Click the image and you can view the record file.

- Select a file and click  Backup. You can save current file to peripheral storage devices.

- Select a file and click  Locked . You can lock current file in case it will be overwritten.
- Select a file and click  Tag . You can mark the time of the detected event.

## 5.14.6 Non-Motor Vehicle Detection

Non-motor vehicle detection uses video image recognition technology to extract information such as non-motor vehicle model, color and number of people in the video image, and match with the preset search parameters. You can search and play back the record of a particular non-motor vehicle or the record of all non-motor vehicles.

 NOTE

Only some devices support this function.

Step 1 Select Smart Search > Non-Motor Vehicle Detection.

The Non-Motor Vehicle Detection interface is displayed. See Figure 5-195.

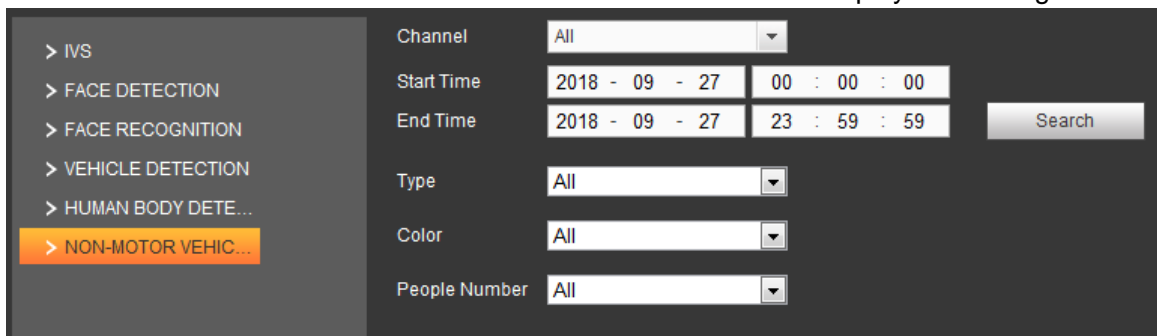

Figure 5-195

Step 2 Select the channel and configure the search parameters as needed.

Step 3 Click Search.

The results are displayed. See Figure 5-196



Figure 5-196

Step 4 Click the image and you can view the record file.

- Click **Export Plat...** to export the non-motor vehicle information to local PC.
- Select a file and click **Backup**. You can save current file to peripheral storage devices.
- Select a file and click **Locked**. You can lock current file in case it will be overwritten.
- Select a file and click **Tag**. You can mark the time of the detected event.

## 5.15 Alarm

On the Web interface, click the Alarm tab and the alarm setting interface is displayed. See Figure 5-197. Enable the Message check box and Play Alarm Sound check box, and then select the alarm type. When the corresponding alarm of the device occurs, the corresponding alarm information will be displayed on the interface.

Video loss, motion detection, tampering, and scene change prompts need to be configured the corresponding events on the Video Detection interface.

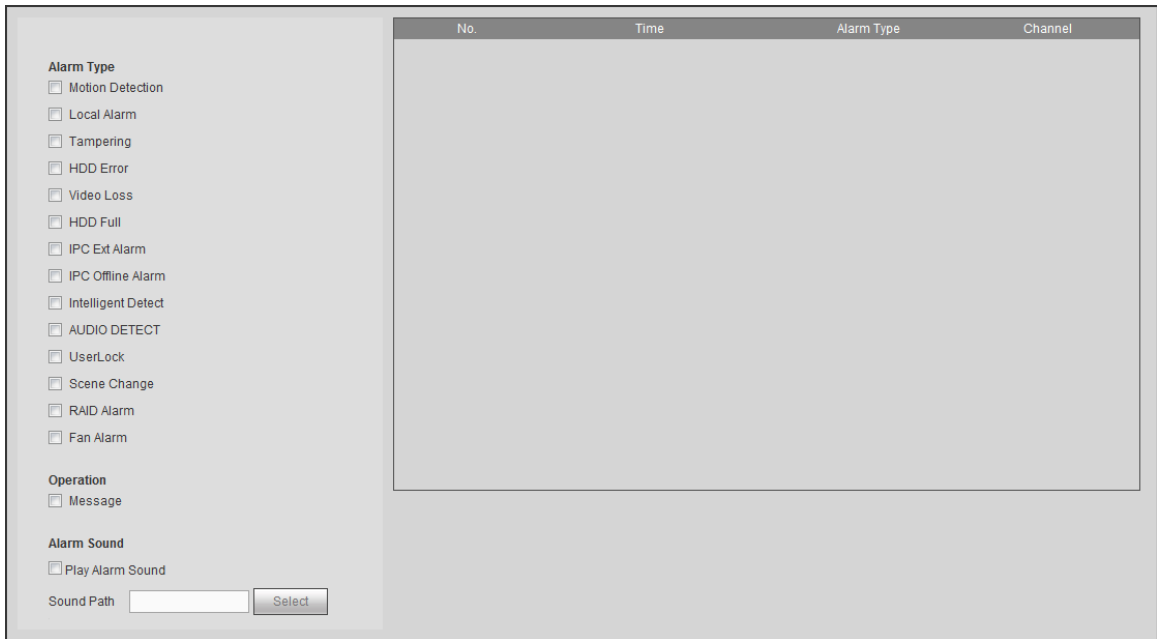

Figure 5-197

Parameter	Description
Alarm Type	Select the check box and select the alarm type. When the corresponding alarm event is triggered, the system records the alarm information.
Message	Select Message check box. When an alarm occurs on other pages, an alarm icon will appear at the Alarm tab on the menu bar.
Play Alarm Sound	Select Play Alarm Sound. The system plays alarm sound when the alarm is activated. The alarm sound can be customized.
Sound Path	Click Select to customize the save path of the alarm sound.

## 5.16 Log out

Click log out button, system goes back to log in interface. See Figure 5-198.  
You need to input user name and password to login again.

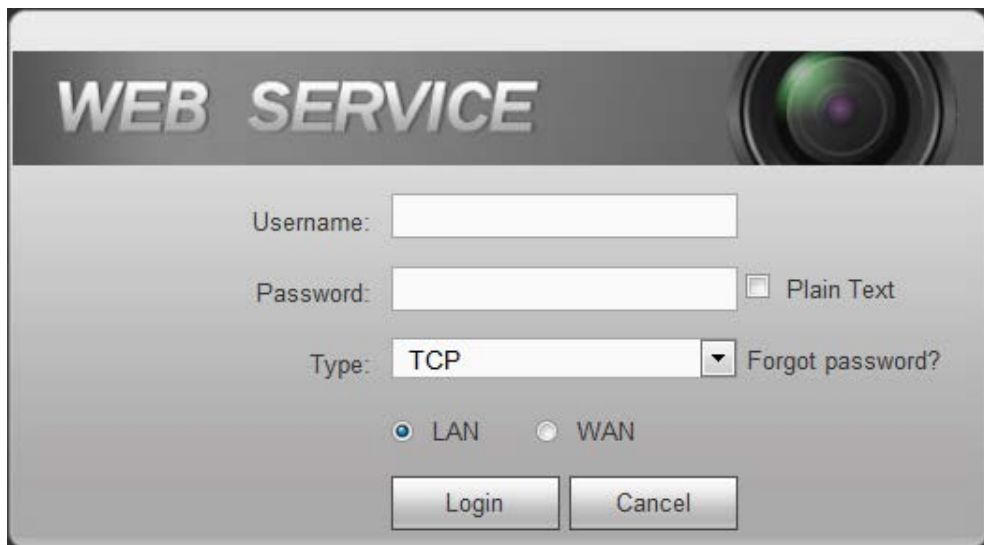

Figure 5-198

## 5.17 Un-install Web Control

You can use web un-install tool “uninstall web.bat” to un-install web control.



Before the un-installation, please close all web pages, otherwise the un-installation might result in error.

# 6 Glossary

- **DHCP:** DHCP (Dynamic Host Configuration Protocol) is a network protocol. It is one of the TCP/IP protocol cluster. It is principally used to assign temporary IP addresses to computers on a network.
- **DDNS:** DDNS (Dynamic Domain Name Server) is a service that maps Internet domain names to IP addresses. This service is useful to anyone who wants to operate a server (web server, mail server, ftp server and etc) connected to the internet with a dynamic IP or to someone who wants to connect to an office computer or server from a remote location with software.
- **eSATA:** eSATA(External Serial AT) is an interface that provides fast data transfer for external storage devices. It is the extension specifications of a SATA interface.
- **PPPoE: PPPoE** (Point to Point Protocol over Ethernet) is a specification for connecting multiple computer users on an Ethernet local area network to a remote site. Now the popular mode is ADSL and it adopts PPPoE protocol.
- **Dual-stream:** The dual-stream technology adopts high-rate bit stream for local HD storage such as QCIF/CIF/2CIF/DCIF/4CIF encode and one low-rate bit stream for network transmission such as QCIF/CIF encode. It can balance the local storage and remote network transmission. The dual-stream can meet the difference band width requirements of the local transmission and the remote transmission. In this way, the local transmission using high-bit stream can achieve HD storage and the network transmission adopting low bit stream suitable for the fluency requirements of the 3G network such as WCDMA, EVDO, TD-SCDMA..
- **On-off value:** It is the non-consecutive signal sampling and output. It includes remote sampling and remote output. It has two statuses: 1/0.



# 7 FAQ

Questions	Solutions
<p><b>NVR cannot boot up properly.</b></p>	<ul style="list-style-type: none"> <li>● Input power is not correct.</li> <li>● Power connection is not correct.</li> <li>● Power switch button is damaged.</li> <li>● Program upgrade is wrong.</li> <li>● HDD malfunction or something wrong with HDD ribbon.</li> <li>● Seagate DB35.1, DB35.2, SV35 or Maxtor 17-g has compatibility problem. Please upgrade to the latest version to solve this problem.</li> <li>● Front panel error.</li> <li>● Main board is damaged.</li> </ul>
<p><b>NVR often automatically shuts down or stops running.</b></p>	<ul style="list-style-type: none"> <li>● Input voltage is not stable or it is too low.</li> <li>● HDD malfunction or something wrong with the ribbon.</li> <li>● Button power is not enough.</li> <li>● Front video signal is not stable.</li> <li>● Working environment is too harsh, too much dust.</li> <li>● Hardware malfunction.</li> </ul>
<p><b>System cannot detect hard disk.</b></p>	<ul style="list-style-type: none"> <li>● HDD is broken.</li> <li>● HDD ribbon is damaged.</li> <li>● HDD cable connection is loose.</li> <li>● Main board SATA port is broken.</li> </ul>
<p><b>There is no video output whether it is one-channel, multiple-channel or all-channel output.</b></p>	<ul style="list-style-type: none"> <li>● Program is not compatible. Please upgrade to the latest version.</li> <li>● Brightness is 0. Please restore factory default setup.</li> <li>● Check your screen saver.</li> <li>● NVR hardware malfunctions.</li> </ul>
<p><b>I cannot search local records.</b></p>	<ul style="list-style-type: none"> <li>● HDD ribbon is damaged.</li> <li>● HDD is broken.</li> <li>● Upgraded program is not compatible.</li> <li>● The recorded file has been overwritten.</li> <li>● Record function has been disabled.</li> </ul>
<p><b>Video is distorted when searching local records.</b></p>	<ul style="list-style-type: none"> <li>● Video quality setup is too low.</li> <li>● Program read error, bit data is too small. There is mosaic in the full screen. Please restart the NVR to solve this problem.</li> <li>● HDD data ribbon error.</li> <li>● HDD malfunction.</li> <li>● NVR hardware malfunctions.</li> </ul>
<p><b>Time display is not correct.</b></p>	<ul style="list-style-type: none"> <li>● Setup is not correct</li> <li>● Battery contact is not correct or voltage is too low.</li> <li>● Crystal is broken.</li> </ul>

Questions	Solutions
<b>NVR cannot control PTZ.</b>	<ul style="list-style-type: none"> <li>● Front panel PTZ error</li> <li>● PTZ decoder setup, connection or installation is not correct.</li> <li>● Cable connection is not correct.</li> <li>● PTZ setup is not correct.</li> <li>● PTZ decoder and NVR protocol is not compatible.</li> <li>● PTZ decoder and NVR address is not compatible.</li> <li>● When there are several decoders, please add 120 Ohm between the PTZ decoder A/B cables furthest end to delete the reverberation or impedance matching. Otherwise the PTZ control is not stable.</li> <li>● The distance is too far.</li> </ul>
<b>I cannot log in client-end or web.</b>	<ul style="list-style-type: none"> <li>● For Windows 98 or Windows ME user, please update your system to Windows 2000 sp4. Or you can install client-end software of lower version. Please note right now, our NVR is not compatible with Windows VISTA control.</li> <li>● ActiveX control has been disabled.</li> <li>● No dx8.1 or higher. Please upgrade display card driver.</li> <li>● Network connection error.</li> <li>● Network setup error.</li> <li>● Password or user name is invalid.</li> <li>● Client-end is not compatible with NVR program.</li> </ul>
<b>There is only mosaic no video when preview or playback video file remotely.</b>	<ul style="list-style-type: none"> <li>● Network fluency is not good.</li> <li>● Client-end resources are limit.</li> <li>● Current user has no right to monitor.</li> </ul>
<b>Network connection is not stable.</b>	<ul style="list-style-type: none"> <li>● Network is not stable.</li> <li>● IP address conflict.</li> <li>● MAC address conflict.</li> <li>● PC or device network card is not good.</li> </ul>
<b>Burn error /USB back error.</b>	<ul style="list-style-type: none"> <li>● Burner and NVR are in the same data cable.</li> <li>● System uses too much CPU resources. Please stop record first and then begin backup.</li> <li>● Data amount exceeds backup device capacity. It may result in burner error.</li> <li>● Backup device is not compatible.</li> <li>● Backup device is damaged.</li> </ul>
<b>Keyboard cannot control NVR.</b>	<ul style="list-style-type: none"> <li>● NVR serial port setup is not correct</li> <li>● Address is not correct</li> <li>● When there are several switchers, power supply is not enough.</li> <li>● Transmission distance is too far.</li> </ul>

Questions	Solutions
<b>Alarm signal cannot be disarmed.</b>	<ul style="list-style-type: none"> <li>● Alarm setup is not correct.</li> <li>● Alarm output has been open manually.</li> <li>● Input device error or connection is not correct.</li> <li>● Some program versions may have this problem. Please upgrade your system.</li> </ul>
<b>Alarm function is null.</b>	<ul style="list-style-type: none"> <li>● Alarm setup is not correct.</li> <li>● Alarm cable connection is not correct.</li> <li>● Alarm input signal is not correct.</li> <li>● There are two loops connect to one alarm device.</li> </ul>
<b>Record storage period is not enough.</b>	<ul style="list-style-type: none"> <li>● Camera quality is too low. Lens is dirty. Camera is installed against the light. Camera aperture setup is not correct.</li> <li>● HDD capacity is not enough.</li> <li>● HDD is damaged.</li> </ul>
<b>Cannot playback the downloaded file.</b>	<ul style="list-style-type: none"> <li>● There is no media player.</li> <li>● No DXB8.1 or higher graphic acceleration software.</li> <li>● There is no DivX503Bundle.exe control when you play the file transformed to AVI via media player.</li> <li>● No DivX503Bundle.exe or ffdshow-2004 1012 .exe in Windows XP OS.</li> </ul>
<b>Forgot local menu operation password or network password.</b>	<ul style="list-style-type: none"> <li>● Please contact your local service engineer or our sales person for help. We can guide you to solve this problem.</li> </ul>
<b>There is no video. The screen is in black.</b>	<ul style="list-style-type: none"> <li>● IPC IP address is not right.</li> <li>● IPC port number is not right.</li> <li>● IPC account (user name/password) is not right.</li> <li>● IPC is offline.</li> </ul>
<b>The displayed video is not full in the monitor.</b>	Please check current resolution setup. If the current setup is 1920*1080, then you need to set the monitor resolution as 1920*1080.
<b>There is no HDMI output.</b>	<ul style="list-style-type: none"> <li>● Displayer is not in HDMI mode.</li> <li>● HDMI cable connection is not right.</li> </ul>
<b>The video is not fluent when I view in multiple-channel mode from the client-end.</b>	<ul style="list-style-type: none"> <li>● The network bandwidth is not sufficient. The multiple-channel monitor operation needs at least 100M or higher.</li> <li>● Your PC resources are not sufficient. For 16-ch remote monitor operation, the PC shall have the following environment: Quad Core, 2G or higher memory, independent displayer, display card memory 256M or higher.</li> </ul>

Questions	Solutions
<b>I can not connect to the IPC.</b>	<ul style="list-style-type: none"> <li>● Please make sure the IPC has booted up.</li> <li>● IPC network connection is right and it is online</li> <li>● IPC IP is in the blocklist.</li> <li>● The device has connected to the too many IPC. It cannot transmit the video.</li> <li>● Check the IPC port value and the time zone is the same as the NVR.</li> <li>● Make sure current network environment is stable.</li> </ul>
<b>After I set the NVR resolution as 1080P, my monitor can not display.</b>	Shut down the device and then reboot. When you reboot, please press the Fn button at the same time and then release after 5 seconds. You can restore NVR resolution to the default setup.
<b>My admin account has been changed and I can not log in.</b>	Use telnet and then input the following command: <pre>cd /mnt/mtd/Config/ rm -rf group rm -rf password</pre> Reboot the device to restore the default password.
<b>After I login the Web , I can not find the remote interface to add the IPC.</b>	Please clear the Web controls and load again.
<b>There is IP and gateway, I can access the internet via the router. But I can not access the internet after I reboot the NVR.</b>	Please use command PING to check you can connect to the gateway or not. Use telnet to access and then use command “ifconfig –a” to check device IP address. If you see the subnet mask and the gateway has changed after the reboot. Please upgrade the applications and set again.
<b>I use the VGA montior.I want to know if I use the multiple-window mode, should I see the video from the main stream or the sub stream.</b>	<ul style="list-style-type: none"> <li>● For 32-channel series product, the 9/16-window is using the sub stream.</li> <li>● For 4/8/16 series product, system is using the main stream no matter you are in what display mode.</li> </ul>

## Daily Maintenance

- Please use the brush to clean the board, socket connector and the chassis regularly.
- The device shall be soundly earthed in case there is audio/video disturbance. Keep the device away from the static voltage or induced voltage.
- Please unplug the power cable before you remove the audio/video signal cable, RS232 or RS485 cable.
- Do not connect the TV to the local video output port (VOUT).It may result in video output circuit.
- Always shut down the device properly. Please use the shutdown function in the menu, or you can press the power button in the rear pane for at least three seconds to shut down the device. Otherwise it may result in HDD malfunction.

- Please make sure the device is away from the direct sunlight or other heating sources. Please keep the sound ventilation.
- Please check and maintain the device regularly.

## Appendix 1 HDD Capacity Calculation

Calculate total capacity needed by each device according to video recording (video recording type and video file storage time).

Step 1: According to Formula (1) to calculate storage capacity  $q_i$  that is the capacity of each channel needed for each hour, unit Mbyte.

$$q_i = d_i \div 8 \times 3600 \div 1024 \quad (1)$$

In the formula:  $d_i$  means the bit rate, unit Kbit/s

Step 2: After video time requirement is confirmed, according to Formula (2) to calculate the storage capacity  $m_i$ , which is storage of each channel needed unit Mbyte.

$$m_i = q_i \times h_i \times D_i \quad (2)$$

In the formula:

$h_i$  means the recording time for each day (hour)

$D_i$  means number of days for which the video shall be kept

Step 3: According to Formula (3) to calculate total capacity (accumulation)  $q_T$  that is needed for all channels in the device during **scheduled video recording**.

$$q_T = \sum_{i=1}^c m_i \quad (3)$$

In the formula:  $c$  means total number of channels in one device

Step 4: According to Formula (4) to calculate total capacity (accumulation)  $q_T$  that is needed for all channels in device during **alarm video recording (including motion detection)**.

$$q_T = \sum_{i=1}^c m_i \times a\% \quad (4)$$

In the formula:  $a\%$  means alarm occurrence rate

## Appendix 2 Compatible Network Camera List

Please note all the models in the following list for reference only. For those products not included in the list, please contact your local retailer or technical supporting engineer for detailed information.

Manufacture	Model	Version	Video Encode	Audio/Video	Protocol
AXIS	P1346	5.40.9.2	H264	√	ONVIF/Private
	P3344/P3344-E	5.40.9.2	H264	√	ONVIF/Private
	P5512	—	H264	√	ONVIF/Private
	Q1604	5.40.3.2	H264	√	ONVIF/Private
	Q1604-E	5.40.9	H264	√	ONVIF/Private
	Q6034E	—	H264	√	ONVIF/Private
	Q6035	5.40.9	H264	√	ONVIF/Private
	Q1755	—	H264	√	ONVIF/Private
	M7001	—	H264	√	Private
	M3204	5.40.9.2	H264	√	Private
	P3367	HEAD LFP4_0 130220	H264	√	ONVIF
P5532-P	HEAD LFP4_0 130220	H264	√	ONVIF	
ACTi	ACM-3511	A1D-220-V3.12 .15-AC	MPEG4	√	Private
	ACM-8221	A1D-220-V3.13 .16-AC	MPEG4	√	Private
Arecont	AV1115	65246	H264	√	Private
	AV10005DN	65197	H264	√	Private
	AV2115DN	65246	H264	√	Private
	AV2515DN	65199	H264	√	Private
	AV2815	65197	H264	√	Private
	AV5115DN	65246	H264	√	Private
	AV8185DN	65197	H264	√	Private
Bosch	NBN-921-P	—	H264	√	ONVIF
	NBC-455-12P	—	H264	√	ONVIF
	VG5-825	9500453	H264	√	ONVIF
	NBN-832	66500500	H264	√	ONVIF
	VEZ-211-IWT EIVA	—	H264	√	ONVIF
	NBC-255-P	15500152	H264	√	ONVIF
	VIP-X1XF	—	H264	√	ONVIF
Brikcom	B0100	—	H264	√	ONVIF

Manufacture	Model	Version	Video Encode	Audio/Video	Protocol
	D100	—	H264	√	ONVIF
	GE-100-CB	—	H264	√	ONVIF
	FB-100A	v1.0.3.9	H264	√	ONVIF
	FD-100A	v1.0.3.3	H264	√	ONVIF
Cannon	VB-M400	—	H264	√	Private
CNB	MPix2.0DIR	XNETM112011 1229	H264	√	ONVIF
	VIPBL1.3MIR VF	XNETM210011 1229	H264	√	ONVIF
	IGC-2050F	XNETM210011 1229	H264	√	ONVIF
CP PLUS	CP-NC9-K	6.E.2.7776	H264	√	ONVIF/Private
	CP-NC9W-K	6.E.2.7776	H264	√	Private
	CP-ND10-R	cp20111129AN S	H264	√	ONVIF
	CP-ND20-R	cp20111129AN S	H264	√	ONVIF
	CP-NS12W-C R	cp20110808NS	H264	√	ONVIF
	VS201	cp20111129NS	H264	√	ONVIF
	CP-NB20-R	cp20110808BN S	H264	√	ONVIF
	CP-NT20VL3- R	cp20110808BN S	H264	√	ONVIF
	CP-NS36W-A R	cp20110808NS	H264	√	ONVIF
	CP-ND20VL2- R	cp20110808BN S	H264	√	ONVIF
	CP-RNP-1820	cp20120821NS A	H264	√	Private
	CP-RNC-TP2 0FL3C	cp20120821NS A	H264	√	Private
	CP-RNP-12D	cp20120828AN S	H264	√	Private
	CP-RNC-DV1 0	cp20120821NS A	H264	√	Private
CP-RNC-DP2 0FL2C	cp20120821NS A	H264	√	Private	
Dynacolor	ICS-13	d20120214NS	H264	√	ONVIF/Private
	ICS-20W	vt20111123NSA	H264	√	ONVIF/Private
	NA222	—	H264	√	ONVIF
	MPC-IPVD-03 13	k20111208ANS	H264	√	ONVIF/Private



Manufacture	Model	Version	Video Encode	Audio/Video	Protocol
	MPC-IPVD-0313AF	k20111208BNS	H264	√	ONVIF/Private
Honeywell	HIDC-1100PT	h.2.2.1824	H264	√	ONVIF
	HIDC-1100P	h.2.2.1824	H264	√	ONVIF
	HIDC-0100P	h.2.2.1824	H264	√	ONVIF
	HIDC-1300V	2.0.0.21	H264	√	ONVIF
	HICC-1300W	2.0.1.7	H264	√	ONVIF
	HICC-2300	2.0.0.21	H264	√	ONVIF
	HDZ20HDX	H20130114NSA	H264	√	ONVIF
LG	LW342-FP	—	H264	√	Private
	LNB5100	—	H264	√	ONVIF
Imatek	KNC-B5000	—	H264	√	Private
	KNC-B5162	—	H264	√	Private
	KNC-B2161	—	H264	√	Private
Panasonic	NP240/CH	—	MPEG4	√	Private
	WV-NP502	—	MPEG4	√	Private
	WV-SP102H	1.41	H264	√	ONVIF/Private
	WV-SP105H	—	H264	√	ONVIF/Private
	WV-SP302H	1.41	H264、MPEG4	√	ONVIF/Private
	WV-SP306H	1.4	H264、MPEG4	√	ONVIF/Private
	WV-SP508H	—	H264、MPEG4	√	ONVIF/Private
	WV-SP509H	—	H264、MPEG4	√	ONVIF/Private
	WV-SF332H	1.41	H264、MPEG4	√	ONVIF/Private
	WV-SW316H	1.41	H264、MPEG4	√	ONVIF/Private
	WV-SW355H	1.41	H264、MPEG4	√	ONVIF/Private
	WV-SW352H	—	H264、MPEG4	√	ONVIF/Private
	WV-SW152E	1.03	H264、MPEG4	√	ONVIF/Private
	WV-SW558H	—	H264、MPEG4	√	ONVIF/Private
	WV-SW559H	—	H264、MPEG4	√	ONVIF/Private
	WV-SP105H	1.03	H264、MPEG4	√	ONVIF/Private
	WV-SW155E	1.03	H264、MPEG4	√	ONVIF/Private
	WV-SF336H	1.44	H264、MPEG4	√	ONVIF/Private
	WV-SF332H	1.41	H264、MPEG4	√	ONVIF/Private
	WV-SF132E	1.03	H264、MPEG4	√	ONVIF/Private
	WV-SF135E	1.03	H264、MPEG4	√	ONVIF/Private
	WV-SF346H	1.41	H264、MPEG4	√	ONVIF/Private
	WV-SF342H	1.41	H264、MPEG4	√	ONVIF/Private
	WV-SC385H	1.08	H264、MPEG4	√	ONVIF/Private
	WV-SC386H	1.08	H264、MPEG4	√	ONVIF/Private
	WV-SP539	1.66	H264、MPEG4	√	ONVIF
	DG-SC385	1.66	H264、MPEG4	√	ONVIF
PELCO	IXSOLW	1.8.1-20110912	H264	√	Private

Manufacture	Model	Version	Video Encode	Audio/Video	Protocol
		-1.9082-A1.6617			
	IDE20DN	1.7.41.9111-O3.6725	H264	√	Private
	D5118	1.7.8.9310-A1.5288	H264	√	Private
	IM10C10	1.6.13.9261-O2.4657	H264	√	Private
	DD4N-X	01.02.0015	MPEG4	√	Private
	DD423-X	01.02.0006	MPEG4	√	Private
	D5220	1.8.3-FC2-20120614-1.9320-A1.8035	H264	√	Private
Samsung	SNB-3000P	2.41	H264、MPEG4	√	ONVIF/Private
	SNP-3120	1.22_110120_1	H264、MPEG4	√	ONVIF/Private
	SNP-3370	1.21_110318	MPEG4	√	Private
	SNB-5000	2.10_111227	H264、MPEG4	√	ONVIF/Private
	SND-5080	—	H264、MPEG4	√	Private
	SNZ-5200	1.02_110512	H264、MPEG4	√	ONVIF/Private
	SNP-5200	1.04_110825	H264、MPEG4	√	ONVIF/Private
	SNB-7000	1.10_110819	H264	√	ONVIF/Private
	SNB-6004	V1.0.0	H264	√	ONVIF
Sony	SNC-DH110	1.50.00	H264	√	ONVIF/Private
	SNC-CH120	1.50.00	H264	√	ONVIF/Private
	SNC-CH135	1.73.01	H264	√	ONVIF/Private
	SNC-CH140	1.50.00	H264	√	ONVIF/Private
	SNC-CH210	1.73.00	H264	√	ONVIF/Private
	SNC-DH210	1.73.00	H264	√	ONVIF/Private
	SNC-DH240	1.50.00	H264	√	ONVIF/Private
	SNC-DH240-T	1.73.01	H264	√	ONVIF/Private
	SNC-CH260	1.74.01	H264	√	ONVIF/Private
	SNC-CH280	1.73.01	H264	√	ONVIF/Private
	SNC-RH-124	1.73.00	H264	√	ONVIF/Private
	SNC-RS46P	1.73.00	H264	√	ONVIF/Private
	SNC-ER550	1.74.01	H264	√	ONVIF/Private
	SNC-ER580	1.74.01	H264	√	ONVIF/Private
	SNC-ER580	1.78.00	H264	√	ONVIF
	SNC-VM631	1.4.0	H264	√	ONVIF
	WV-SP306	1.61.00	H264、MPEG4	√	SDK
	WV-SP306	1.61.00	H264	√	ONVIF
	SNC-VB600	1.5.0	H264	√	Private
	SNC-VM600	1.5.0	H264	√	Private
	SNC-VB630	1.5.0	H264	√	Private

<b>Manufacture</b>	<b>Model</b>	<b>Version</b>	<b>Video Encode</b>	<b>Audio/Video</b>	<b>Protocol</b>
	SNC-VM630	1.5.0	H264	√	Private
SANYO	VCC-HDN400 0PC	—	H264	√	ONVIF

# Appendix 3 Cybersecurity Recommendations

## **Mandatory actions to be taken for basic device network security:**

### **1. Use Strong Passwords**

Please refer to the following suggestions to set passwords:

- The length should not be less than 8 characters.
- Include at least two types of characters; character types include upper and lower case letters, numbers and symbols.
- Do not contain the account name or the account name in reverse order.
- Do not use continuous characters, such as 123, abc, etc.
- Do not use overlapped characters, such as 111, aaa, etc.

### **2. Update Firmware and Client Software in Time**

- According to the standard procedure in Tech-industry, we recommend to keep your device (such as NVR, DVR, IP camera, etc.) firmware up-to-date to ensure the system is equipped with the latest security patches and fixes. When the device is connected to the public network, it is recommended to enable the “auto-check for updates” function to obtain timely information of firmware updates released by the manufacturer.
- We suggest that you download and use the latest version of client software.

## **"Nice to have" recommendations to improve your device network security:**

### **1. Physical Protection**

We suggest that you perform physical protection to device, especially storage devices. For example, place the device in a special computer room and cabinet, and implement well-done access control permission and key management to prevent unauthorized personnel from carrying out physical contacts such as damaging hardware, unauthorized connection of removable device (such as USB flash disk, serial port), etc.

### **2. Change Passwords Regularly**

We suggest that you change passwords regularly to reduce the risk of being guessed or cracked.

### **3. Set and Update Passwords Reset Information Timely**

The device supports password reset function. Please set up related information for password reset in time, including the end user’s mailbox and password protection questions. If the information changes, please modify it in time. When setting password protection questions, it is suggested not to use those that can be easily guessed.

### **4. Enable Account Lock**

The account lock feature is enabled by default, and we recommend you to keep it on to guarantee the account security. If an attacker attempts to log in with the wrong password several times, the corresponding account and the source IP address will be locked.

### **5. Change Default HTTP and Other Service Ports**

We suggest you to change default HTTP and other service ports into any set of numbers between 1024–65535, reducing the risk of outsiders being able to guess which ports you are using.

### **6. Enable HTTPS**

We suggest you to enable HTTPS, so that you visit Web service through a secure communication channel.

#### **7. MAC Address Binding**

We recommend you to bind the IP and MAC address of the gateway to the device, thus reducing the risk of ARP spoofing.

#### **8. Assign Accounts and Privileges Reasonably**

According to business and management requirements, reasonably add users and assign a minimum set of permissions to them.

#### **9. Disable Unnecessary Services and Choose Secure Modes**

If not needed, it is recommended to turn off some services such as SNMP, SMTP, UPnP, etc., to reduce risks.

If necessary, it is highly recommended that you use safe modes, including but not limited to the following services:

- SNMP: Choose SNMP v3, and set up strong encryption passwords and authentication passwords.
- SMTP: Choose TLS to access mailbox server.
- FTP: Choose SFTP, and set up strong passwords.
- AP hotspot: Choose WPA2-PSK encryption mode, and set up strong passwords.

#### **10. Audio and Video Encrypted Transmission**

If your audio and video data contents are very important or sensitive, we recommend that you use encrypted transmission function, to reduce the risk of audio and video data being stolen during transmission.

Reminder: encrypted transmission will cause some loss in transmission efficiency.

#### **11. Secure Auditing**

- Check online users: we suggest that you check online users regularly to see if the device is logged in without authorization.
- Check device log: By viewing the logs, you can know the IP addresses that were used to log in to your devices and their key operations.

#### **12. Network Log**

Due to the limited storage capacity of the device, the stored log is limited. If you need to save the log for a long time, it is recommended that you enable the network log function to ensure that the critical logs are synchronized to the network log server for tracing.

#### **13. Construct a Safe Network Environment**

In order to better ensure the safety of device and reduce potential cyber risks, we recommend:

- Disable the port mapping function of the router to avoid direct access to the intranet devices from external network.
- The network should be partitioned and isolated according to the actual network needs. If there are no communication requirements between two sub networks, it is suggested to use VLAN, network GAP and other technologies to partition the network, so as to achieve the network isolation effect.
- Establish the 802.1x access authentication system to reduce the risk of unauthorized access to private networks.
- Enable IP/MAC address filtering function to limit the range of hosts allowed to access the device.